

# 1938

DESIGNED IN 1938 BY  
*Mamoli R&D*  
Restyled in 2022 by  
*Fabrizio Batoni*



#41380000065F

Cromo  
Chrome

Nero PVD  
PVD Black

Ottone Spazzolato PVD  
PVD brushed Brass

Nero PVD  
PVD Black

Inox Spazzolato PVD  
PVD brushed Inox

Nero PVD  
PVD Black



#41380000065G



#45380000065G



#45390000062G

1938



45380000065F





1938



#41380000065F



#41380000065G



CODICE/CODE EURO

■	453800000651	929,00
■	45380000065G	1.092,00
■	45380000065F	1.092,00

Batteria per lavabo a 3 fori con scarico da 5/4" con comando a pressione  
3-holes basin mixer with 5/4" up&down system pop-up waste

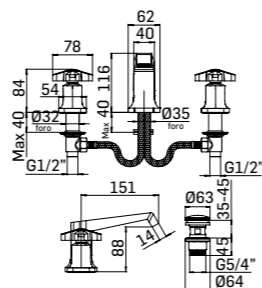

CODICE/CODE EURO

■	243300000621	310,00
■	24330000062G	387,00
■	24330000062F	387,00

Deviatore da incasso a 2 uscite, composto da parte grezza e parte esterna di finitura  
Concealed 2-ways diverter composed by assembly components and external components

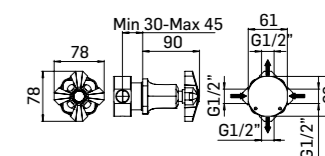

■	413800000651	555,00
■	41380000065G	719,00
■	41380000065F	719,00

Miscelatore monocomando per lavabo con scarico da 5/4" con comando a pressione  
Single lever basin mixer with 5/4" up&down system popup waste

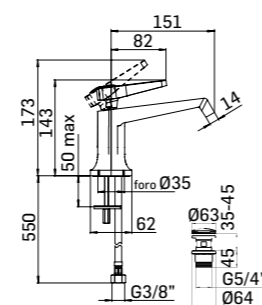

■	243600000621	310,00
■	24360000062G	387,00
■	24360000062F	387,00

Deviatore da incasso a 3 uscite, composto da parte grezza e parte esterna di finitura  
Concealed 3-ways diverter composed by assembly components and external components

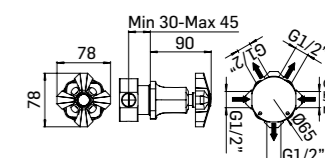

■	453900000621	724,00
■	45390000062G	884,00
■	45390000062F	884,00

Batteria per lavabo a muro  
Wall-mounted basin mixer

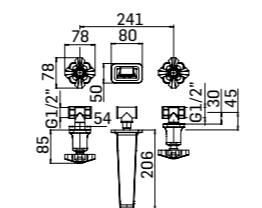

■	553800000651	947,00
■	55380000065G	1.124,00
■	55380000065F	1.124,00

Batteria per bidet a 3 fori con scarico da 5/4" con comando a pressione  
3-holes bidet mixer with 5/4" up&down system pop-up waste

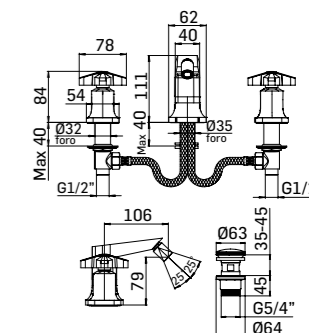

■	2438F1140621	1.499,00
■	2438F114062G	1.885,00
■	2438F114062F	1.885,00

Batteria incasso per vasca completa di bocca a parete e accessorio doccia  
Concealed bath mixers with wall-mounted spout and shower set

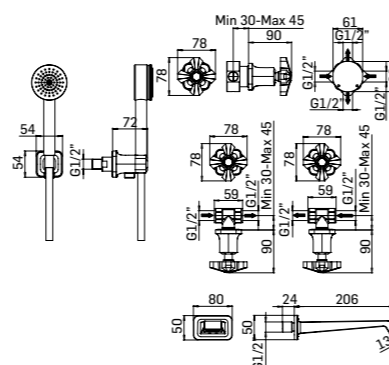

■	513800000651	573,00
■	51380000065G	751,00
■	51380000065F	751,00

Miscelatore monocomando per bidet con scarico da 5/4" con comando a pressione  
Single lever bidet mixer with 5/4" up&down system popup waste

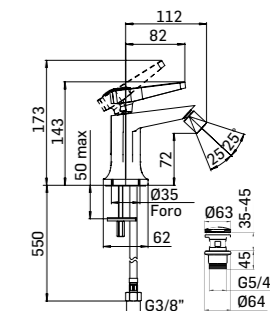

■	243200000621	535,00
■	24320000062G	654,00
■	24320000062F	654,00

Coppia rubinetti da incasso dritti da G1/2"  
1/2" pair of straight stopcocks

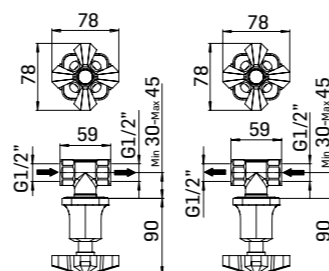

■	2478PE000601	668,00
■	2478PE00060G	791,00
■	2478PE00065F	791,00

Parte esterna di finitura per miscelatore termostatico incasso per doccia con deviatore a 2 uscite  
External components for concealed thermostatic shower mixer 2-ways diverter

Da completare con gruppo termostatico da incasso 271000000027  
To be completed with concealed thermostatic mixer 271000000027

Disponibile dal 1/2024/Available from 2024/1

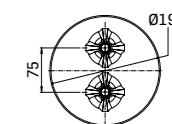



CODICE/CODE EURO

□ 27100000027 223,30

Gruppo doccia incasso termostatico universale  
con deviatore a 2 uscite  
*Universal built-in thermostatic shower mixer  
with 2 ways diverter*

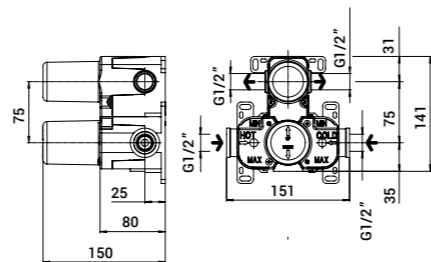

■ 0000F140021 364,00

■ 0000F14002G 514,00

■ 0000F14002F 514,00

Accessorio doccia con presa d'acqua per miscelatori da incasso  
*Shower set with water outlet for built-in mixers*

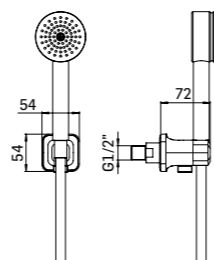

■ 24350000021 290,00

■ 2435000002G 330,00

■ 2435000002F 330,00

Bocca di erogazione a parete  
*Wall-mounted spout*

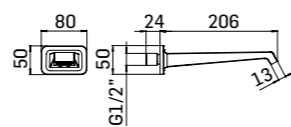

1930 - Spartaco Mamoli comincia a produrre a Milano rubinetti e lampadari in ottone fuso