

GEOMETRICA TONDA - OVALE

design Luigi Brembilla

Geometrica è una collezione che si compone da scaldasalviette costituiti da elementi

geometrici e un maniglione orizzontale che li attraversa e li connote. Il maniglione porta-

salviette può essere anche realizzato con la sporgenza a sinistra del corpo radiante.

TONDA Mod. Geo-T

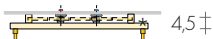

* Mod. Geo-TL
con tubi sul retro

OVALE Mod. Geo-O

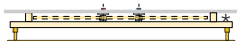

* Mod. Geo-OL
con tubi sul retro

OVALE-V Mod. Geo-OV

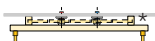

* Mod. Geo-OVL
con tubi sul retro

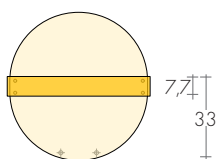

Geo-T.. 58-56

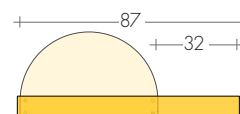

Geo-T.. 58-87

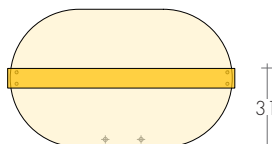

Geo-O.. 54-89

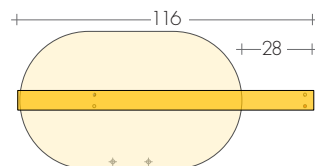

Geo-O.. 54-116

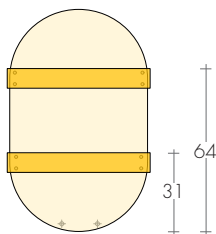
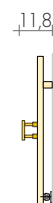

Geo-OV.. 87-56

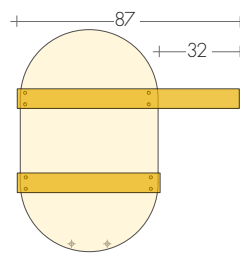

Geo-OV.. 87-87



MODELLO	Bianco sablé		EN 442		▲ ▼ int.att. cm	Altezza H cm	Larghezza L cm	Peso M Kg	Volume V dm ³	Versioni MISTE (R.E. cl.II) con manicotto:		
	HL cm	di serie €	Δt 50 K watt	Δt 30 K watt						cavo ^o €	W	termostato digitale €
Geo-T	58-56	760,00	312	164	14	58	56	9,2	3,7	115,10	250	181,50
Geo-TL	58-56	930,00	449	236	14	58	56	13,5	5,0	117,20	400	183,60
Geo-T	58-87	785,00	344	181	14	58	87	9,8	3,9	117,20	400	183,60
Geo-TL	58-87	955,00	481	253	14	58	87	14,1	5,2	119,30	500	185,70
Geo-O	54-89	810,00	514	270	14	54	89	15,0	6,2	119,30	500	185,70
Geo-OL	54-89	980,00	734	386	14	54	89	21,9	8,3	121,30	650	187,70
Geo-O	54-116	845,00	543	286	14	54	116	15,5	6,3	119,30	500	185,70
Geo-OL	54-116	1015,00	763	401	14	54	116	22,4	8,4	121,30	650	187,70
Geo-OV	87-56	910,00	539	284	14	87	56	15,4	6,3	119,30	500	185,70
Geo-OVL	87-56	1080,00	759	399	14	87	56	22,3	8,4	125,70	800	192,10
Geo-OV	87-87	935,00	571	300	14	87	87	16,0	6,5	121,30	650	187,70
Geo-OVL	87-87	1105,00	791	416	14	87	87	22,9	8,6	125,70	800	192,10

^oCronotermistato radio p.227

A RICHIESTA, SENZA SUPPLEMENTO, BARRA PORTASALVIETTE CON SPORGENZA A SINISTRA

BARRA PORTASALVIETTE, COLORI STANDARD:

- bianco sablé SB 9016
- grigio quarzo mica sablé SB 7039
- nero mica sablé SB 9005
- nel colore del radiatore

COLORI della tabella Brem diverso dal radiatore Supplemento 32,20€

ESECUZIONI DI SERIE

Colore bianco sablé SB9016 mensola B35
Tolleranze ± 3mm - Valvola di sfiato ø 1/8"
PRESSIONE MASSIMA D'ESERCIZIO 4 BAR

ESECUZIONI A RICHIESTA

Verniciatura in una tinta della tabella colori Brem (con fissaggi B35 colorati) +15/25%
Versione elettrica, su richiesta

ATTACCHI DI SERIE

Attacchi Remoti
REM ø 1/2"
A richiesta attacchi verticali EG ø 1/2"



INTERASSE ATTACCHI

Di serie Attacchi Remoti sul retro della piastra

Mod. Geo-T.. Geo-OV..

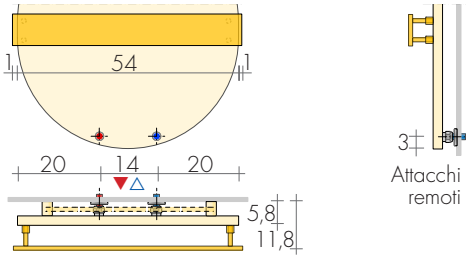

Su richiesta attacchi verticali EG ▲▼ 14 cm, con manicotti e valvole a vista.

Mod. Geo-O..

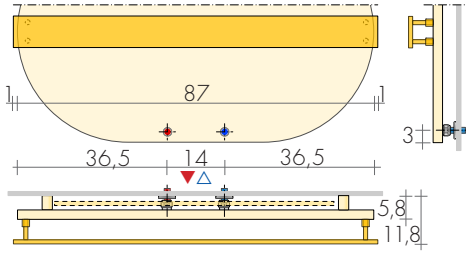

Su richiesta attacchi verticali EG ▲▼ 14 cm, con manicotti e valvole a vista.

FISSAGGI

Mensole B35 comprese

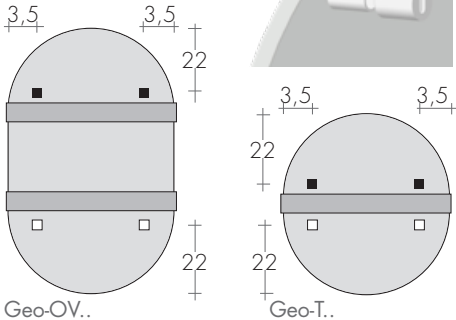

Geo-OV..

Geo-T..

Geo-O..

□ mensole per modelli elettrici

VALVOLE CONSIGLIATE

KIT VALVOLE REMOTE COMPRENDE:

- n°2 Valvole ad incasso con volantini Cromo
- n°2 Raccordi (per multistrato ø16 e rame ø12,14)
- n°2 Rosette tonde

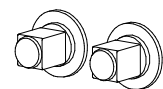
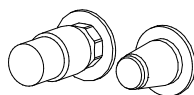

KIT GRUPPO VALVOLE REMOTE TON
Art. KVG 142,20€

KIT GRUPPO VALVOLE REMOTE TON con
Testa TERMOSTATICA Art. KVGT 185,00€

KIT GRUPPO VALVOLE REMOTE QUADRA
Art. KQG 178,60€



ATTACCHI REMOTI

