

IUNIX



STAINLESS STEEL
SHOWER ENCLOSURE PERFECTION

PROVEX
comfort in the bathroom

INDICE IUNIX
 INHALT IUNIX
 INDEX IUNIX
 INDICE IUNIX

ALL
 SPECIAL

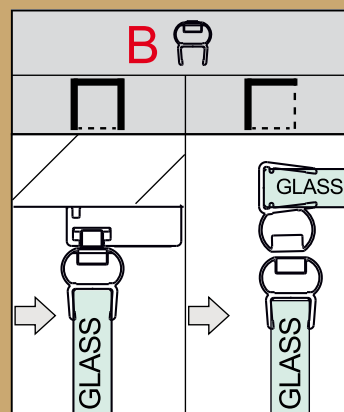
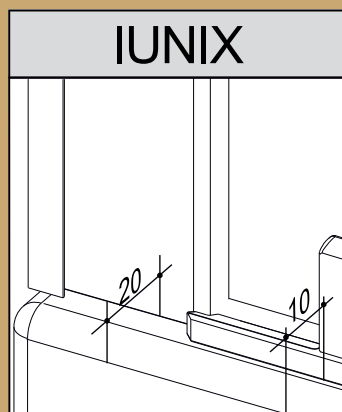
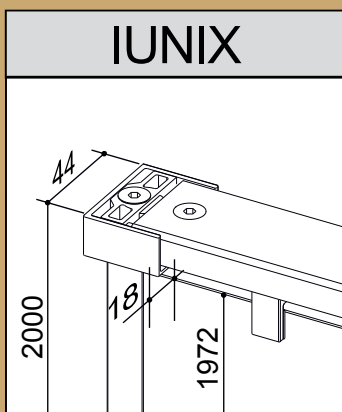
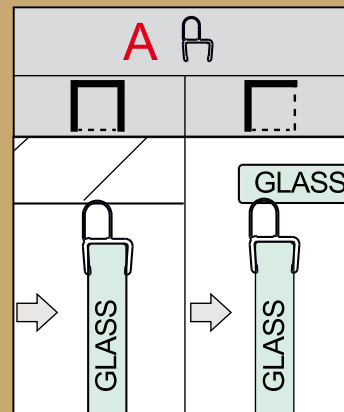
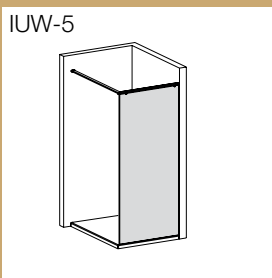
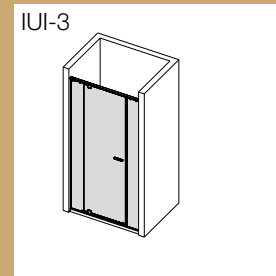
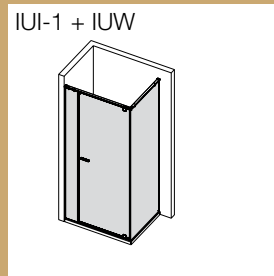
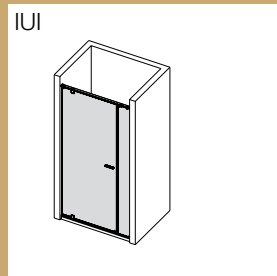
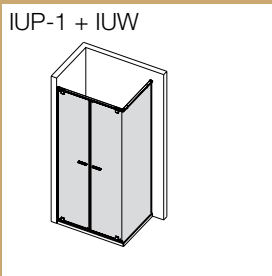
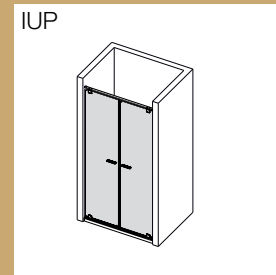
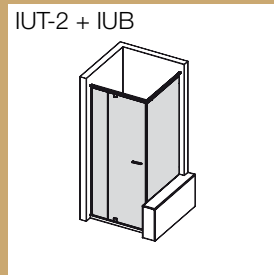
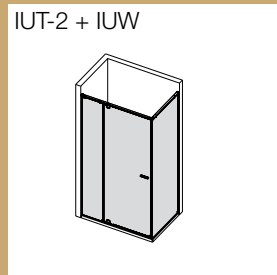
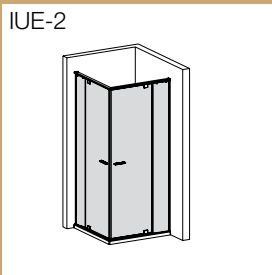
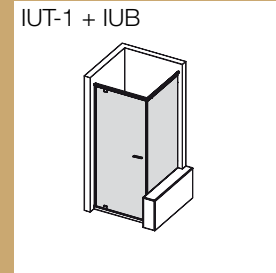
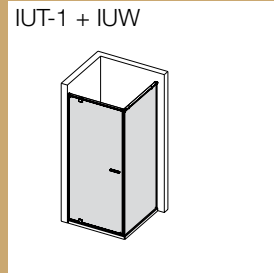
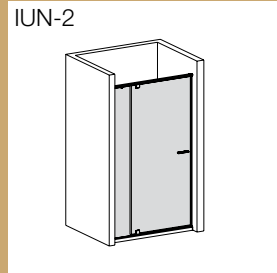
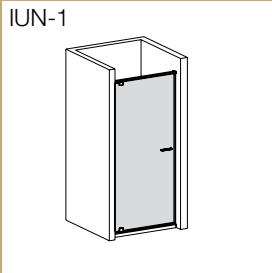

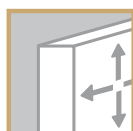

BOX DOCCIA SENZA TELAIO

- Design Studio Provex
- Acciaio inossidabile AISI 316L con eccellente resistenza alla corrosione e ai graffi
- Alluminio anodizzato per le finiture brillante lucido e nero matt
- Massima trasparenza con il sistema a cerniera
- Viti planari all'interno del box per facilitare la pulizia
- Lavorazione completamente su misura
- Cerniera con sistema a pendolo fino a 360°
- Porte con meccanismo di sollevamento/abbassamento
- Guarnizione verticale continua per ottima tenuta acqua

RAHMENLOSE KABINEN

- Design Studio Provex
- Rostfreier Edelstahl V4A mit ausgezeichneten Anforderungen an Korrosion- und Kratzbeständigkeit
- Eloxiertes Aluminium für die Profilfarben brillant glänzend und schwarz matt
- Maximale Transparenz durch die Scharniertechnik
- Scharnierschrauben sind für eine ideale Reinigung im Glas innen versenkt
- Verarbeitung komplett als Sonderausführung
- Scharnier mit Pendelanschlag bis zu 360°
- Türelemente mit Hebe- Senkmechanismus
- Durchgehendes vertikales Dichtungsprofil für optimale Wasserdichtigkeit

FRAMELESS SHOWER ENCLOSURE

- Design Studio Provex
- Stainless steel AISI 316L with excellent corrosion and scratch resistance
- Anodized aluminum for the profile colors brilliant shining and black matt
- Maximum transparency through hinge technology
- Hinge screws are sunk into the glass to optimize cleaning
- Manufacture completely on special size
- Pivoting in/out hinge up to 360°
- Door elements with up and down lifting mechanism
- Continuous vertical sealing profile for optimal water resistance

CABINA DE DUCHA SIN PERFIL

- Design Studio Provex
- Acero inoxidable AISI 316L con una excelente resistencia a la corrosión y al rayado
- Aluminio anodizado para los colores de perfil brillante y negro mate
- Máxima transparencia con el sistema de bisagra
- Tornillos planos en el interior de la cabina para optimizar la limpieza
- Fabricación totalmente de medida especial
- Bisagra pivotante in/out hasta 360°
- Puertas con mecanismo de levantamiento/descenso
- Perfil de sellado vertical continuo para la resistencia óptima de agua

IUNIX IUN-1

PORTA BASCULANTE 1 ANTA
PENDELTÜR 1-TEILIG
SALOON DOOR 1 PANEL
PUERTA BASCULANTE 1 PIEZA

ALL
SPECIAL





High
GLASS



IUNIX
2000



GH High GLASS GL 8 mm

01 05 10

Descrizione Articolo Artikelbezeichnung Model description Descripción artículo	Articolo Artikel Model Código	Misura piatto doccia Tassenmaß Tray size Medidas del plato mm	Estensibilità Verstellbarkeit Adjustability Extensibilidad mm	Entrata larghezza Einstiegsbreite Entry width Ancho de entrada mm	 A
 Porta basculante 1 anta* Pendeltür 1-teilig* Saloon door 1 panel* Puerta basculante 1 pieza*	IUN01 0013 - L/R	625 - 825	5	- 235	Larghezza nicchia Nischenbreite Width niche
	IUN01 0035 - L/R	826 - 1025	5		210
					210

*Il lato di montaggio della cerniera da definire nell'ordine (sinistra L - destra R) / Montageseite des Scharniers bei Bestellung definieren (links L - rechts R)
 Define the hinge assembly side when ordering (left L - right R) / Lado bisagra de la asamblea se indican en el pedido (izquierda L - derecha R)

Rilievo misura e montaggio box doccia da parte dei ns. CAT sempre richiesto - articolo sempre fuori misura
Aufmaß und Montage durch Kundendienst immer erforderlich - Artikel ist immer Sondermaß
Measuring and installation through service center always requested - article is always special measure
 La **medición** y la **instalación** a través del centro de servicio siempre solicitado - artículo es siempre medida especial



IUN - L

IUN - R

IUNIX IUN-2

PORTA BASCULANTE IN LINEA
PENDELTÜR IN LINIE
SALOON DOOR INLINE
PUERTA BASCULANTE EN LINEA

ALL
SPECIAL





High
GLASS



IUN-2
2000



GH
High
GLASS

GL

8 mm

01

05

10



Descrizione Articolo Artikelbezeichnung Model description Descripción artículo	Articolo Artikel Model Código	Misura piatto doccia Tassenmaß Tray size Medidas del plato mm	Estensibilità Verstellbarkeit Adjustability Extensibilidad mm	Entrata larghezza Einstiegsbreite Entry width Ancho de entrada mm A	
 Porta basculante in linea* Pendeltür in Linie* Saloon door inline* Puerta basculante en línea*	IUN02 0035 - L/R	825 - 1025	5 + 5	550	
	IUN02 0057 - L/R	1026 - 1225	5 + 5	650	
	IUN02 0079 - L/R	1226 - 1425	5 + 5	750	

*Il lato di montaggio della cerniera da definire nell'ordine (sinistra L - destra R) / Montageseite des Scharniers bei Bestellung definieren (links L - rechts R)
 Define the hinge assembly side when ordering (left L - right R) / Lado bisagra de la asamblea se indican en el pedido (izquierda L - derecha R)

Rilievo misura e montaggio box doccia da parte dei ns. CAT sempre richiesto - articolo sempre fuori misura
Aufmaß und Montage durch Kundendienst immer erforderlich - Artikel ist immer Sondermaß
Measuring and installation through service center always requested - article is always special measure
 La **medición** y la **instalación** a través del centro de servicio siempre solicitado - artículo es siempre medida especial

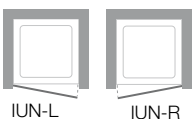

IUN-L

IUN-R

IUNIX IUT-1 + IUW/IUB

PORTA BASCULANTE CON LATERALE
PENDELTÜR MIT SEITENTEIL
SALOON DOOR WITH SIDE PANEL
PUERTA BASCULANTE CON LATERAL

ALL
SPECIAL





High
GLASS



IUT-1 2000	IUW 2000	IUB max. 1800	
---------------	-------------	------------------	--

GH High GLASS	GL	8 mm
---------------------	----	------

01	05	10	
----	----	----	--

Descrizione Articolo Artikelbezeichnung Model description Descripción artículo	Articolo Artikel Model Código	Misura piatto doccia Tassenmaß Tray size Medidas del plato mm	Estensibilità Verstellbarkeit Adjustability Extensibilidad mm	Entrata larghezza Einstiegsbreite Entry width Ancho de entrada mm											
<p>Porta basculante* Pendeltür* Saloon door* Puerta basculante*</p>	IUT01 0013 - L/R	625 - 825	5	- 220	<table border="1"> <tr> <td>Larghezza porta Türbreite Width door</td> <td>210</td> <td></td> <td></td> <td></td> </tr> <tr> <td></td> <td>210</td> <td></td> <td></td> <td></td> </tr> </table>	Larghezza porta Türbreite Width door	210					210			
	Larghezza porta Türbreite Width door	210													
		210													
IUT01 0035 - L/R	826 - 1025	5													
<p>Laterale* Seitenteil* Side panel* Pared lateral*</p>	IUW00 0013 - L/R	625 - 825	5												
	IUW00 0035 - L/R	826 - 1025	5												
	IUW00 0057 - L/R	1026 - 1225	5												
<p>Laterale per vasca* Seitenteil für Badewanne* Side panel for bathtub* Pared lateral para bañera*</p>	IUB00 0015 - L/R	650 - 1000	5												

*Il lato di montaggio da definire nell'ordine (sinistra L - destra R) / Montageseite bei Bestellung definieren (links L - rechts R)
Define the assembly side when ordering (left L - right R) / Lado de la asamblea se indican en el pedido (izquierda L - derecha R)

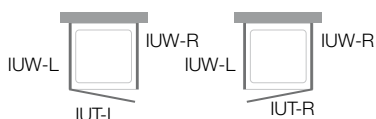

IUNIX IUE-2

BOX AD ANGOLO CON PORTE BASCULANTI

ECKEINSTIEG MIT PENDELTÜREN

CORNER ENTRY WITH PIVOTING DOORS

CABINA ANGULAR CON PUERTAS BASCULANTES

ALL
SPECIAL

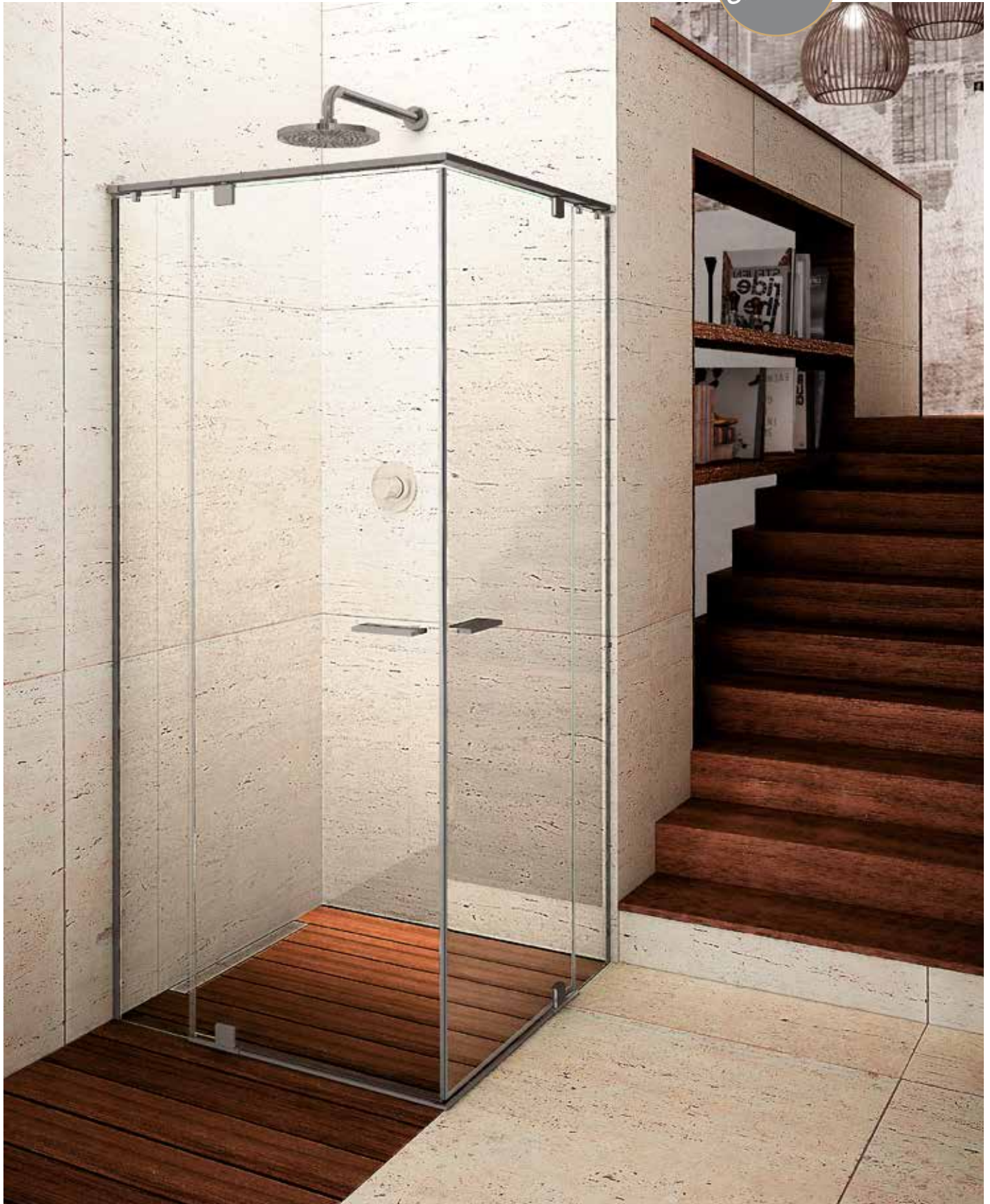



Descrizione Articolo Artikelbezeichnung Model description Descripción artículo	Articolo Artikel Model Código	Misura piatto doccia Tassenmaß Tray size Medidas del plato mm	Estensibilità Verstellbarkeit Adjustability Extensibilidad mm		 A	
 Box ad angolo con porte basculanti* Eckeinstieg mit Pendeltüren* Corner entry with pivoting doors* Cabina angular con puertas basculantes*						
	IN OUT	IUE02 0013 - L/R	700 - 825	5	640	
		IUE02 0035 - L/R	826 - 1025	5	780	
		IUE02 0057 - L/R	1026 - 1225	5	920	

*Il lato di montaggio della cerniera da definire nell'ordine (sinistra L - destra R) / Montageseite des Scharniers bei Bestellung definieren (links L - rechts R)
 Define the hinge assembly side when ordering (left L - right R) / Lado bisagra de la asamblea se indican en el pedido (izquierda L - derecha R)

Rilievo misura e montaggio box doccia da parte dei ns. CAT sempre richiesto - articolo sempre fuori misura
Aufmaß und Montage durch Kundendienst immer erforderlich - Artikel ist immer Sondermaß
Measuring and installation through service center always requested - article is always special measure
 La **medición y la instalación** a través del centro de servicio siempre solicitado - artículo es siempre medida especial

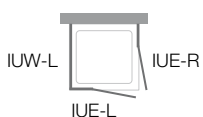

IUNIX IUT-2 + IUW/IUB

PORTA BASCULANTE IN LINEA CON LATERALE

PENDELTÜR IN LINIE MIT SEITENTEIL

SALOON DOOR INLINE WITH SIDE PANEL

PUERTA BASCULANTE EN LINEA CON LATERAL

ALL
SPECIAL





High
GLASS



IUT-2 2000	IUW 2000	IUB max. 1800	
----------------------	--------------------	-------------------------	--

GH High GLASS	GL	8 mm
----------------------------	-----------	-----------------

01	05	10	
-----------	-----------	-----------	--

Descrizione Articolo Artikelbezeichnung Model description Descripción artículo	Articolo Artikel Model Código	Misura piatto doccia Tassenmaß Tray size Medidas del plato mm	Estensibilità Verstellbarkeit Adjustability Extensibilidad mm	Entrata larghezza Einstiegsbreite Entry width Ancho de entrada mm A	
<p>Porta basculante in linea* Pendeltür in Linie* Saloon door inline* Puerta basculante en línea*</p>	IUT02 0035 - L/R	825 - 1025	5	550	
	IUT02 0057 - L/R	1026 - 1225	5	650	
	IUT02 0079 - L/R	1226 - 1425	5	750	
<p>Laterale* Seitenteil* Side panel* Pared lateral*</p>	IUW00 0013 - L/R	625 - 825	5		
	IUW00 0035 - L/R	826 - 1025	5		
	IUW00 0057 - L/R	1026 - 1225	5		
<p>Laterale per vasca* Seitenteil für Badewanne* Side panel for bathtub* Pared lateral para bañera*</p>	IUB00 0015 - L/R	650 - 1000	5		

*Il lato di montaggio da definire nell'ordine (sinistra L - destra R) / Montageseite bei Bestellung definieren (links L - rechts R)
Define the assembly side when ordering (left L - right R) / Lado de la asamblea se indican en el pedido (izquierda L - derecha R)

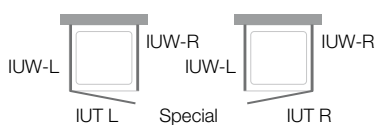

IUNIX IUP

DOPPIA PORTA BASCULANTE
2-TEILIGE PENDELTÜR
DOUBLE SALOON DOOR
PUERTA BASCULANTE DOBLE

ALL
SPECIAL



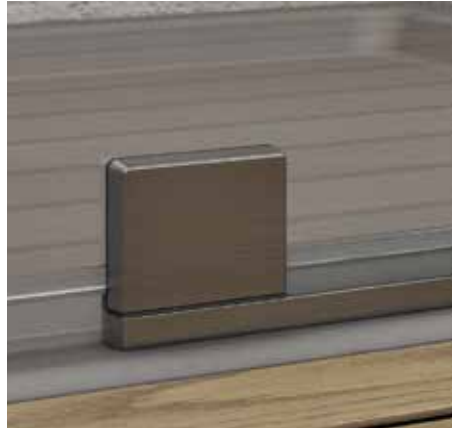

High GLASS



IUP 2000



GH High GLASS GL 8 mm

01 05 10



Descrizione Articolo Artikelbezeichnung Model description Descripción artículo	Articolo Artikel Model Código	Misura piatto doccia Tassenmaß Tray size Medidas del plato mm	Estensibilità Verstellbarkeit Adjustability Extensibilidad mm	Entrata larghezza Einstiegsbreite Entry width Ancho de entrada mm		
<p>Doppia porta basculante 2-teilige Pendeltür Saloon door double Puerta basculante doble</p>	IUP00 0013	625 - 825	5 + 5	- 220	A	
	IUP00 0035	826 - 1025	5 + 5		Larghezza nicchia Nischenbreite Width niche	100
	IUP00 0057	1026 - 1225	5 + 5		100	

Rilievo misura e montaggio box doccia da parte dei ns. CAT sempre richiesto - articolo sempre fuori misura
Aufmaß und Montage durch Kundendienst immer erforderlich - Artikel ist immer Sondermaß
Measuring and installation through service center always requested - article is always special measure
La medición y la instalación a través del centro de servicio siempre solicitado - artículo es siempre medida especial

IUNIX IUP-1 + IUW

DOPPIA PORTA BASCULANTE CON LATERALE

2-TEILIGE PENDELTÜR MIT SEITENTEIL

DOUBLE SALOON DOOR WITH SIDE PANEL

PUERTA BASCULANTE DOBLE CON LATERAL

ALL
SPECIAL





High
GLASS



IUP-1 2000 IUW 2000



GH High GLASS GL 8 mm

01 05 10

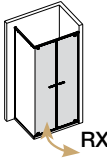
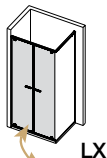
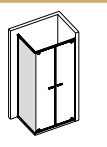

Descrizione Articolo Artikelbezeichnung Model description Descripción artículo	Articolo Artikel Model Código	Misura piatto doccia Tassenmaß Tray size Medidas del plato mm	Estensibilità Verstellbarkeit Adjustability Extensibilidad mm	Entrata larghezza Einstiegsbreite Entry width Ancho de entrada mm				
 <p>Doppia porta basculante 2-teilige Pendeltür Saloon door double Puerta basculante doble</p>	IUP01 0013 - R	625 - 825	5	- 220	Larghezza porta Türbreite Width door	100		
	IUP01 0035 - R	826 - 1025	5			100		
	IUP01 0057 - R	1026 - 1225	5			100		
 <p>Doppia porta basculante 2-teilige Pendeltür Saloon door double Puerta basculante doble</p>	IUP01 0013 - L	625 - 825	5	- 220	Larghezza porta Türbreite Width door	100		
	IUP01 0035 - L	826 - 1025	5			100		
	IUP01 0057 - L	1026 - 1225	5			100		
 <p>Laterale Seitenteil Side panel Pared lateral</p>	IUW00 0013 - L/R	625 - 825	5					
	IUW00 0035 - L/R	826 - 1025	5					
	IUW00 0057 - L/R	1026 - 1225	5					

Rilievo misura e **montaggio** box doccia da parte dei ns. CAT sempre richiesto - articolo sempre fuori misura

Aufmaß und **Montage** durch Kundendienst immer erforderlich - Artikel ist immer Sondermaß

Measuring and **installation** through service center always requested - article is always special measure

La **medición** y la **instalación** a través del centro de servicio siempre solicitado - artículo es siempre medida especial

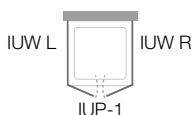

IUNIX IUI

PORTA BASCULANTE IN LINEA
PENDELTÜR IN LINIE
SALOON DOOR INLINE
PUERTA BASCULANTE EN LINEA

ALL
SPECIAL





High GLASS



IUI 2000



GH High GLASS GL 8 mm

01 05 10



Descrizione Articolo Artikelbezeichnung Model description Descripción artículo	Articolo Artikel Model Código	Misura piatto doccia Tassenmaß Tray size Medidas del plato mm	Estensibilità Verstellbarkeit Adjustability Extensibilidad mm	Entrata larghezza Einstiegsbreite Entry width Ancho de entrada mm A	B	
<p>Porta basculante in linea* Pendeltür in Linie* Saloon door inline* Puerta basculante en línea*</p>	IUI00 0035 - L/R	825 - 1025	5 + 5	550	100	
	IUI00 0057 - L/R	1026 - 1225	5 + 5	650	100	
	IUI00 0079 - L/R	1226 - 1425	5 + 5	750	100	

*Il lato di montaggio della cerniera da definire nell'ordine (sinistra L - destra R) / Montageseite des Scharniers bei Bestellung definieren (links L - rechts R)
Define the hinge assembly side when ordering (left L - right R) / Lado bisagra de la asamblea se indican en el pedido (izquierda L - derecha R)

Rilievo misura e montaggio box doccia da parte dei ns. CAT sempre richiesto - articolo sempre fuori misura
Aufmaß und Montage durch Kundendienst immer erforderlich - Artikel ist immer Sondermaß
Measuring and installation through service center always requested - article is always special measure
La medición y la instalación a través del centro de servicio siempre solicitado - artículo es siempre medida especial



IUNIX IUI-1 + IUW

PORTA BASCULANTE IN LINEA CON LATERALE
PENDELTÜR IN LINIE MIT SEITENTEIL
SALOON DOOR INLINE WITH SIDE PANEL
PUERTA BASCULANTE EN LINEA CON LATERAL

ALL
SPECIAL





High
GLASS

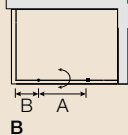
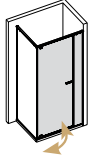
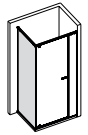

Descrizione Articolo Artikelbezeichnung Model description Descripción artículo	Articolo Artikel Model Código	Misura piatto doccia Tassenmaß Tray size Medidas del plato mm	Estensibilità Verstellbarkeit Adjustability Extensibilidad mm	Entrata larghezza Einstiegsbreite Entry width Ancho de entrada mm A	
 <p>Porta basculante in linea* Pendeltür in Linie* Saloon door inline* Puerta basculante en línea*</p>	IUI01 0035 - L/R	825 - 1025	5	550	100
	IUI01 0057 - L/R	1026 - 1225	5	650	100
	IUI01 0079 - L/R	1226 - 1425	5	750	100
 <p>Laterale* Seitenteil* Side panel* Pared lateral*</p>	IUW00 0013 - L/R	625 - 825	5		
	IUW00 0035 - L/R	826 - 1025	5		
	IUW00 0057 - L/R	1026 - 1225	5		

*Il lato di montaggio da definire nell'ordine (sinistra L - destra R) / Montageseite bei Bestellung definieren (links L - rechts R)
Define the assembly side when ordering (left L - right R) / Lado de la asamblea se indican en el pedido (izquierda L - derecha R)

Rilievo misura e montaggio box doccia da parte dei ns. CAT sempre richiesto - articolo sempre fuori misura
Aufmaß und Montage durch Kundendienst immer erforderlich - Artikel ist immer Sondermaß
Measuring and installation through service center always requested - article is always special measure
La medición y la instalación a través del centro de servicio siempre solicitado - artículo es siempre medida especial



IUNIX IUI-3

PORTA BASCULANTE CON 2 FISSI IN LINEA

PENDELTÜR MIT 2 FESTFELDERN IN LINIE

SALOON DOOR WITH 2 IN-LINE FIXED PANELS

PUERTA BASCULANTE CON 2 LATERALES FIJOS

ALL
SPECIAL





High
GLASS



IUI-3
2000



GH
High
GLASS

GL

8 mm

01

05

10



Descrizione Articolo Artikelbezeichnung Model description Descripción artículo	Articolo Artikel Model Código	Misura piatto doccia Tassenmaß Tray size Medidas del plato mm	Estensibilità Verstellbarkeit Adjustability Extensibilidad mm	Entrata larghezza Einstiegsbreite Entry width Ancho de entrada mm A	
<p>Porta pivotante* Pendeltür* Saloon door* Puerta pivotante*</p>	IUI03 T 009 - L/R	1200 - 1425	5	650	
	IUI03 T 011 - L/R	1426 - 1625	5	750	
	IUI03 T 013 - L/R	1626 - 1825	5	750	
<p>Laterali in Linea* Festfelder in Linie* In-line panels* Laterales fijos*</p>	IUI03 S 009	1200 - 1425	5		
	IUI03 S 011	1426 - 1625	5		
	IUI03 S 013	1626 - 1825	5		

*Il lato di montaggio da definire nell'ordine (sinistra L - destra R) / Montageseite bei Bestellung definieren (links L - rechts R)
Define the assembly side when ordering (left L - right R) / Lado de la asamblea se indican en el pedido (izquierda L - derecha R)

Rilievo misura e montaggio box doccia da parte dei ns. CAT sempre richiesto - articolo sempre fuori misura
Aufmaß und Montage durch Kundendienst immer erforderlich - Artikel ist immer Sondermaß
Measuring and installation through service center always requested - article is always special measure
La medición y la instalación a través del centro de servicio siempre solicitado - artículo es siempre medida especial

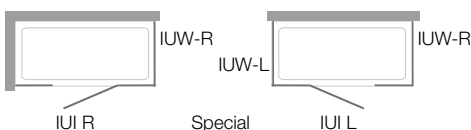

IUNIX IUW-5

PARETE DOCCIA CON SOSTEGNO
RAUMABTRENNUNG MIT STÜTZE
SHOWER SCREEN WITH SUPPORT
SEPARA EL ESPACIO CON APOYO

ALL
SPECIAL

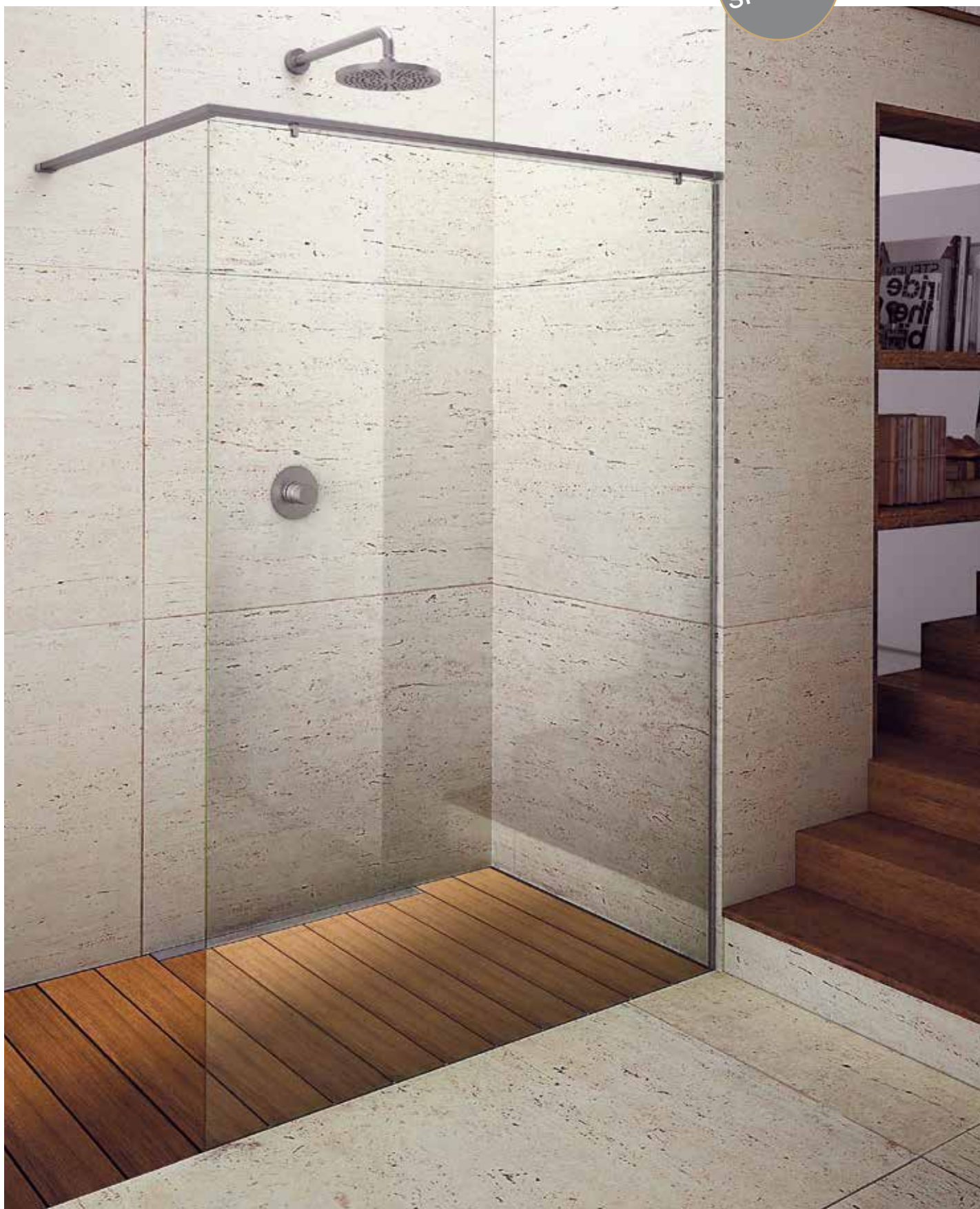



Descrizione Articolo Artikelbezeichnung Model description Descripción artículo	Articolo Artikel Model Código	Misura piatto doccia Tassenmaß Tray size Medidas del plato mm	Estensibilità Verstellbarkeit Adjustability Extensibilidad mm	Estensibilità Verstellbarkeit Adjustability Extensibilidad mm	
		A	A	B	
	Parete doccia con sostegno* Raumabtrennung mit Stütze* Shower screen with support* Separa el espacio con apoyo*	IUW05 0015 - L/R	625 - 1025	5	5
	IUW05 0057 - L/R	1026 - 1225	5	5	
	IUW05 0079 - L/R	1226 - 1425	5	5	
	IUW05 0911 - L/R	1426 - 1625	5	5	

*Il lato di montaggio da definire nell'ordine (sinistra L - destra R) / Montageseite bei Bestellung definieren (links L - rechts R)
Define the assembly side when ordering (left L - right R) / Lado de la asamblea se indican en el pedido (izquierda L - derecha R)

Rilievo misura e montaggio box doccia da parte dei ns. CAT sempre richiesto - articolo sempre fuori misura
Aufmaß und Montage durch Kundendienst immer erforderlich - Artikel ist immer Sondermaß
Measuring and installation through service center always requested - article is always special measure
La **medición** y la **instalación** a través del centro de servicio siempre solicitado - artículo es siempre medida especial

