

TABELLA PREZZI FINITURE pag. 418

INFO TECNICHE pag. 418

INDICE / INDEX pag. 420

LAVABO pag. 428

BIDET pag. 435

DOCCIA INCASSO pag. 436

DEVIATORI INCASSO pag. 438

DOCCIA ESTERNO pag. 440

DOCCIA ESTERNO  
THERMOSTATICO pag. 440

VASCA pag. 440

BAGNO COMPLEMENTI pag. 443

**PREZZO FINITURE**

Calcola il prezzo di listino (IVA esclusa) delle finiture diverse dal cromato, consultando la seguente tabella.

Moltiplicare il **PREZZO LISTINO** per il **COEFFICIENTE MOLTIPLICATORE** della finitura scelta, arrotondando per difetto il prezzo ottenuto (eliminare i centesimi).  
**ESEMPIO** per ordinare art. 4805 in finitura dorato: codice **04-4805**

**PRICE FINISHES**

Include the list price (excluding VAT) of different finishes from chrome, consulting the following table. **Multiply the PRICE LIST MULTIPLIER COEFFICIENT** of the chosen finish, reducing the price obtained by deleting the centesim.

**EXAMPLE** to order art. 4805 gold finish: code **04-4805**

**COMPOSIZIONE CODICE PER ORDINARE ARTICOLO IN FINITURA**



**CODICE FINITURA**  
FINISH CODE

**CODICE ARTICOLO**  
ITEM NUMBER

**FINITURE DI SERIE / STANDARD FINISHES**

CODICE CODE	DESCRIZIONE FINITURA FINISH DESCRIPTION	MOLTIPLIC. MULTIPLIER JEANS	MOLTIPLIC. MULTIPLIER JQ
<b>01-</b>	cromato / chrome		<b>PREZZO LISTINO°</b>
<b>34-</b>	cromo spazzolato / brushing chrome	x	x
<b>66-</b>	bianco opaco / mat white	x	x
<b>75-</b>	dorato spazzolato / brushing gold	x	x

**FINITURE A RICHIESTA / ON REQUEST FINISHES**

CODICE CODE	DESCRIZIONE FINITURA FINISH DESCRIPTION	MOLTIPLIC. MULTIPLIER JEANS	MOLTIPLIC. MULTIPLIER JQ
<b>19-</b>	nero / black	x	x
<b>28-</b>	nickel satinato / satin nickel	x	x
<b>30-</b>	nickel lucido / polished nickel	x	x
<b>33-</b>	cromo satinato / satin chrome	x	x
<b>35-</b>	nickel spazzolato / brushing nickel	x	x
<b>56-</b>	avorio / ivory	x	x
<b>57-</b>	azzurro / light blue	x	x
<b>58-</b>	verdino / light green	x	x
<b>59-</b>	marrone / brown	x	x
<b>60-</b>	arancio / orange	x	x
<b>61-</b>	rosso / red	x	x
<b>67-</b>	nero opaco / mat black	x	x
<b>68-</b>	rame opaco / mat copper	x	x
<b>69-</b>	argento opaco / mat silver	x	x
<b>71-</b>	oro opaco / mat gold	x	x
<b>72-</b>	bronzo opaco / mat bronze	x	x
<b>87-</b>	oro rosa / pink gold	x	x
<b>88-</b>	ottone sisal / sisal brass	x	<b>N. R.*</b>

**FINITURE A RICHIESTA / ON REQUEST FINISHES**

CODICE CODE	DESCRIZIONE FINITURA FINISH DESCRIPTION	MOLTIPLIC. MULTIPLIER JEANS	MOLTIPLIC. MULTIPLIER JQ
<b>02-</b>	cromo/oro / chrome/gold	x	x
<b>03-</b>	oro/argento / gold/silver	x	x
<b>04-</b>	dorato / gold	x	x
<b>05-</b>	bronzo satinato / satin bronze	x	x
<b>06-</b>	rame vecchio / old copper	x	x
<b>07-</b>	vecchio argento / old silver	x	x
<b>08-</b>	canna di fucile / gun barrel	x	x
<b>10-</b>	verderame / verdigris	x	x
<b>11-</b>	nero antracite / anthracite black	x	x
<b>12-</b>	ottone lucido / polished brass	x	<b>N. R.*</b>
<b>13-</b>	ottone naturale / natural brass	x	<b>N. R.*</b>
<b>14-</b>	bianco / white	x	x

°PREZZO DI LISTINO / PRICE LIST

\*N.R. = NON REALIZZABILE / NOT MADE

**ATTENZIONE! 13-OTTONE NATURALE e 88-OTTONE SISAL: finiture non protette che antichizzano naturalmente ossidando a contatto con l'umidità atmosferica.**  
**WARNING! 13-NATURAL BRASS and 88-SISAL BRASS: unprotected finishes that naturally oxidise in contact with atmospheric humidity.**

**PROGETTO SU MISURA: RICHIESTE SPECIALI**

I tecnici di Bellosta Rubinetterie sono, inoltre, a disposizione di architetti e designers, per offrire un servizio esclusivo: personalizzazioni di elementi in funzione di specifiche richieste estetiche o problematiche legate a vincoli progettuali, verifica della fattibilità attraverso opportuni studi CAD e sviluppo del disegno tecnico del prodotto speciale richiesto.

Per informazioni e richieste PROGETTI SU MISURA:  
 ufficiotecnico@bellostarubinetterie.com



**PROGETTO SU MISURA: SPECIAL REQUESTS**

Engineers Bellosta Rubinetterie are also available to architects and designers, to offer an exclusive service: customizations of items according to specific aesthetic requirements or issues related to design constraints, verification of the feasibility studies and development through appropriate CAD technical design the required special product. For information and requests "SU MISURA" PROJECTS:  
 ufficiotecnico@bellostarubinetterie.com

**CONSIGLIO TECNICO**

Tutti i miscelatori delle collezioni JEANS e JQ vengono collaudati nel loro funzionamento al momento dell'assemblaggio. Per garantire la durata delle cartucce nel tempo, si consiglia di spurgare bene l'impianto idraulico prima del montaggio (per rimuovere eventuali detriti) e di installare rubinetti sottolavabo con filtro (art. 020).

N.B.: Qualora il piano lavabo avesse uno spessore superiore a 5 cm specificare la misura al momento dell'ordine.

**TECHNICAL ADVICE**

All mixers of the JEANS and JQ collections are perfectly tested. To guarantee the perfect functionality of the cartridge for a long time, we advise to clean the sanitary plant before installing the mixer. Moreover we advise to install angle valve with filter (art. 020).

Attention: If the lavatory top is more than cm 5 hick, please point it out when placing the order.

**FORATURA DEI PIANI SANITARI**

I miscelatori lavabo/bidet monoforo prevedono un foro di diametro 35 mm nel piano sanitario.

MONOFORO >>

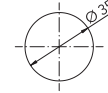

**DRILLING PLANS HEALTH**

The sink / hole bidet mixers provide a hole diameter of 35 mm in the health plan.

**SCHEMA FUNZIONAMENTO DEVIATORI INCASSO 2/3/4 USCITE**

Questi deviatori non hanno funzione di chiusura. Ruotando verso destra o sinistra si attivano le uscite. Tra 2 uscite adiacenti durante la rotazione diminuisce la portata dell'uscita iniziale ed incrementa quella della successiva. In posizione intermedia sono entrambe attive a pari portata.

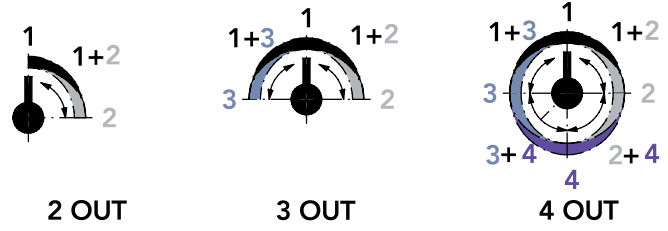

**SCHEME OPERATION SWITCHES FLUSH OUTPUT 2/3/4**

These diverters have not closing function. By turning to the right or left activates the outputs. Between two adjacent outputs during the rotation decreases the initial output flow and increases that of the next. In position intermediate are both active at the same flow rate.

**RISPARMIO ENERGETICO**

Nelle collezioni JEANS e JQ sono disponibili modelli lavabo che rispettano la normativa WELL per il risparmio energetico e idrico.

**FUNZIONAMENTO:** aprendo il miscelatore con leva in posizione frontale viene erogata ACQUA FREDDA; per erogare ACQUA CALDA si deve ruotare la leva a sinistra (unica rotazione possibile), in dotazione è inoltre previsto un limitatore di portata.

**SAFE ENERGY**

In the collections JEANS e JQ are available basin mixer model that respect the WELL laws for the safe energy and water respect.

**FUNCTION:** open the mixer with lever in front position, the COLD WATER is supplied; to supply HOT WATER the lever has to be turn on the left (the only possible rotation). It also provide a limiter flow rate.

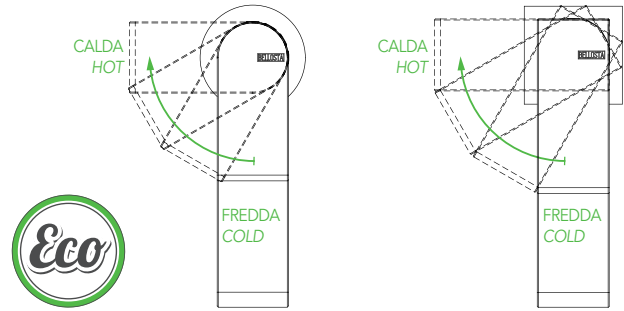

**LEGENDA SIMBOLI**

**ACCESSORI  
ACCESSORIES**

- SCARICO C/TAPPO A PRESSIONE
- WASTE WITH PRESSURE CAP

**RICAMBI IMMEDIATI  
IMMEDIATE PARTS**

- CARTUCCIA CARTRIDGE
- CARTUCCIA DEVIATRICE DIVERTER CARTRIDGE

- CARTUCCIA TERMOSTATICA THERMOSTATIC CARTRIDGE
- DEVIATORE DIVERTER

- VITONE CERAMICO CERAMIC VALVE
- AERATORE TONDO ROUND AERATOR

- VITONE TRADIZIONALE TRADITIONAL VALVE
- AERATORE PIATTO FLAT AERATOR



LAVABO

4805 | JEANS pag. 428

 4805/R | JEANS pag. 428

MISCELATORE LAVABO MONOFORO  
BASIN MIXER



7805 | JQ pag. 428

 7805/R | JQ pag. 428

MISCELATORE LAVABO MONOFORO  
BASIN MIXER



4805/S | JEANS pag. 428

 4805/SR | JEANS pag. 428

MISCELATORE LAVABO MONOFORO  
BASIN MIXER



7805/S | JQ pag. 428

 7805/SR | JQ pag. 428

MISCELATORE LAVABO MONOFORO  
BASIN MIXER



4805/P | JEANS pag. 428

 4805/PR | JEANS pag. 428

MISCELATORE LAVABO MONOFORO BOCCA  
PROLUNGATA  
BASIN MIXER EXTENDED SPOUT



7805/P | JQ pag. 429

 7805/PR | JQ pag. 429

MISCELATORE LAVABO MONOFORO BOCCA  
PROLUNGATA  
BASIN MIXER EXTENDED SPOUT



4805/P/S | JEANS pag. 429

 4805/P/SR | JEANS pag. 429

MISCELATORE LAVABO MONOFORO BOCCA  
PROLUNGATA  
BASIN MIXER EXTENDED SPOUT



7805/P/S | JQ pag. 429

 7805/P/SR | JQ pag. 429

MISCELATORE LAVABO MONOFORO BOCCA  
PROLUNGATA  
BASIN MIXER EXTENDED SPOUT





 4805/PN | JEANS pag. 429

 4805/PRN | JEANS pag. 429

MISCELATORE LAVABO MEDIUM MONOFORO  
BOCCA PROLUNGATA  
BASIN MIXER EXTENDED SPOUT "MEDIUM SIZE"





 7805/PN | JQ pag. 429

 7805/PRN | JQ pag. 429

MISCELATORE LAVABO MEDIUM MONOFORO  
BOCCA PROLUNGATA  
BASIN MIXER EXTENDED SPOUT "MEDIUM SIZE"





 4805/P/SN | JEANS pag. 430

 4805/P/SRN | JEANS pag. 430

MISCELATORE LAVABO MEDIUM MONOFORO  
BOCCA PROLUNGATA  
BASIN MIXER EXTENDED SPOUT "MEDIUM SIZE"



 7805/P/SN | JQ pag. 430

 7805/P/SRN | JQ pag. 430

MISCELATORE LAVABO MEDIUM MONOFORO  
BOCCA PROLUNGATA  
BASIN MIXER EXTENDED SPOUT "MEDIUM SIZE"



4805/P/A | JEANS pag. 430

 4805/P/AR | JEANS pag. 430

MISCELATORE LAVABO MONOFORO BOCCA  
EXTRAPROLUNGATA  
BASIN MIXER EXTRA EXTENDED SPOUT



7805/P/A | JQ pag. 430

 7805/P/AR | JQ pag. 430

MISCELATORE LAVABO MONOFORO BOCCA  
EXTRAPROLUNGATA  
BASIN MIXER EXTRA EXTENDED SPOUT



4805/P/A/S | JEANS pag. 430

 4805/P/A/SR | JEANS pag. 430

MISCELATORE LAVABO MONOFORO BOCCA  
EXTRAPROLUNGATA  
BASIN MIXER EXTRA EXTENDED SPOUT



7805/P/A/S | JQ pag. 431

 7805/P/A/SR | JQ pag. 431

MISCELATORE LAVABO MONOFORO BOCCA  
EXTRAPROLUNGATA  
BASIN MIXER EXTRA EXTENDED SPOUT



LAVABO

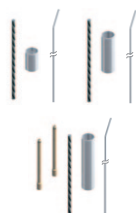

484005, 484006, 484007 | JEANS pag. 431

PROLUNGHE MISCELATORE LAVABO  
EXTENSIONS FOR BASIN

altezza mm 50 / high 50 mm: 484005  
altezza mm 100 / high 100 mm: 484006  
altezza mm 150 / high 150 mm: 484007

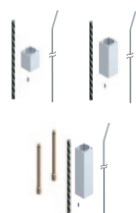

784003, 784004, 784005 | JQ pag. 431

PROLUNGHE MISCELATORE LAVABO  
EXTENSIONS FOR BASIN

altezza mm 50 / high 50 mm: 784003  
altezza mm 100 / high 100 mm: 784004  
altezza mm 150 / high 150 mm: 784005



4805/2 | JEANS pag. 431

4805/2R | JEANS pag. 431

MISCELATORE LAVABO MONOFORO ALTO BOCCA  
PROLUNGATA  
HIGHER BASIN MIXER EXTENDED SPOUT



7805/2 | JQ pag. 431

7805/2R | JQ pag. 431

MISCELATORE LAVABO MONOFORO ALTO BOCCA  
PROLUNGATA  
HIGHER BASIN MIXER EXTENDED SPOUT



4805/1 | JEANS pag. 432

4805/1R | JEANS pag. 432

MISCELATORE LAVABO MONOFORO ALTO BOCCA  
PROLUNGATA  
HIGHER BASIN MIXER EXTENDED SPOUT



7805/1 | JQ pag. 432

7805/1R | JQ pag. 432

MISCELATORE LAVABO MONOFORO ALTO BOCCA  
PROLUNGATA  
HIGHER BASIN MIXER EXTENDED SPOUT



4805/3/A/E + 894001 | JEANS pag. 432

MISCELATORE LAVABO DA PARETE  
WALL BASIN MIXER



parti esterne / external parts: 4805/3/A/E  
parte incasso / built-in part: 894001



4805/3/AQ/E + 894001 | JEANS pag. 432

MISCELATORE LAVABO DA PARETE  
WALL BASIN MIXER



parti esterne / external parts: 4805/3/AQ/E  
parte incasso / built-in part: 894001

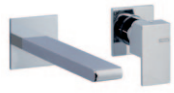

7805/3/A/E + 894001 | JQ pag. 432

MISCELATORE LAVABO DA PARETE  
WALL BASIN MIXER



parti esterne / external parts: 7805/3/A/E  
parte incasso / built-in part: 894001



4805/3/B/E + 894001 | JEANS pag. 433

MISCELATORE LAVABO DA PARETE BOCCA  
PROLUNGATA  
WALL BASIN EXTENDED SPOUT MIXER



parti esterne / external parts: 4805/3/B/E  
parte incasso / built-in part: 894001

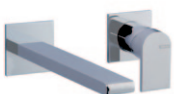

4805/3/BQ/E + 894001 | JEANS pag. 433

MISCELATORE LAVABO DA PARETE BOCCA  
PROLUNGATA  
WALL BASIN EXTENDED SPOUT MIXER



parti esterne / external parts: 4805/3/BQ/E  
parte incasso / built-in part: 894001

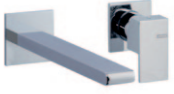

7805/3/B/E + 894001 | JQ pag. 433

MISCELATORE LAVABO DA PARETE BOCCA  
PROLUNGATA  
WALL BASIN EXTENDED SPOUT MIXER



parti esterne / external parts: 7805/3/B/E  
parte incasso / built-in part: 894001



4805/3/E + 894001 | JEANS pag. 433

MISCELATORE LAVABO DA PARETE SU PIASTRA  
WALL BASIN MIXER ON PLATE



parti esterne / external parts: 4805/3/E  
parte incasso / built-in part: 894001

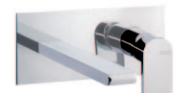

4805/3Q/E + 894001 | JEANS pag. 433

MISCELATORE LAVABO DA PARETE SU PIASTRA  
WALL BASIN MIXER ON PLATE



parti esterne / external parts: 4805/3Q/E  
parte incasso / built-in part: 894001



7805/3/E + 894001 | JQ pag. 434

MISCELATORE LAVABO DA PARETE SU PIASTRA  
WALL BASIN MIXER ON PLATE



parti esterne / external parts: 7805/3/E  
parte incasso / built-in part: 894001



4805/3/1/E + 894001 | JEANS pag. 434

MISCELATORE LAVABO DA PARETE SU PIASTRA  
BOCCA PROLUNGATA  
WALL BASIN MIXER EXTENDED SPOUT ON PLATE



parti esterne / external parts: 4805/3/1/E  
parte incasso / built-in part: 894001

LAVABO



4805/3/1Q/E + 894001 | JEANS pag. 434

MISCELATORE LAVABO DA PARETE SU PIASTRA  
BOCCA PROLUNGATA  
WALL BASIN MIXER EXTENDED SPOUT ON PLATE

parti esterne / external parts: 4805/3/1Q/E  
parte incasso / built-in part: 894001



7805/3/1/E + 894001 | JQ pag. 434

MISCELATORE LAVABO DA PARETE SU PIASTRA  
BOCCA PROLUNGATA  
WALL BASIN MIXER EXTENDED SPOUT ON PLATE

parti esterne / external parts: 7805/3/1/E  
parte incasso / built-in part: 894001



4805/R/A | JEANS pag. 434

MISCELATORE REMOTO  
REMOTE MIXER



7805/R/A | JQ pag. 435

MISCELATORE REMOTO  
REMOTE MIXER



4805/R/B/E + 104033 | JEANS pag. 435

MISCELATORE INCASSO REMOTO  
BUILT-IN REMOTE MIXER



parti esterne / external parts: 4805/R/B/E  
parte incasso / built-in part: 104033



4805/R/BQ/E + 104033 | JEANS pag. 435

MISCELATORE INCASSO REMOTO  
BUILT-IN REMOTE MIXER



parti esterne / external parts: 4805/R/BQ/E  
parte incasso / built-in part: 104033



7805/R/B/E + 104033 | JQ pag. 435

MISCELATORE INCASSO REMOTO  
BUILT-IN REMOTE MIXER



parti esterne / external parts: 7805/R/B/E  
parte incasso / built-in part: 104033

BIDET



4807 | JEANS pag. 435

4807/R | JEANS pag. 435

MISCELATORE BIDET MONOFORO  
BIDET MIXER



7807 | JQ pag. 436

7807/R | JQ pag. 436

MISCELATORE BIDET MONOFORO  
BIDET MIXER

DOCCIA INCASSO



4821/N/E + 104018 | JEANS pag. 436

MISCELATORE INCASSO  
BUILT-IN MIXER



parti esterne / external parts: 4821/N/E  
parte incasso / built-in part: 104018



4821/Q/E + 104018 | JEANS pag. 436

MISCELATORE INCASSO  
BUILT-IN MIXER



parti esterne / external parts: 4821/Q/E  
parte incasso / built-in part: 104018



7821/E + 104018 | JQ pag. 436

MISCELATORE INCASSO  
BUILT-IN MIXER



parti esterne / external parts: 7821/E  
parte incasso / built-in part: 104018



4800/E + 104002 | JEANS pag. 436

MISCELATORE INCASSO C/DEVIATORE 2 USCITE  
BUILT-IN MIXER WITH DIVERTER 2 OUT



parti esterne / external parts: 4800/E  
parte incasso / built-in part: 104002



4800/Q/E + 104002 | JEANS pag. 437

MISCELATORE INCASSO C/DEVIATORE 2 USCITE  
BUILT-IN MIXER WITH DIVERTER 2 OUT



parti esterne / external parts: 4800/Q/E  
parte incasso / built-in part: 104002



7800/E + 104002 | JQ pag. 437

MISCELATORE INCASSO C/DEVIATORE 2 USCITE  
BUILT-IN MIXER WITH DIVERTER 2 OUT



parti esterne / external parts: 7800/E  
parte incasso / built-in part: 104002

**DOCCIA INCASSO**



**4800/1/P/E + 724027 | JEANS** pag. 437

MISCELATORE INCASSO C/DEVIATORE E DOCCINO  
BUILT-IN MIXER WITH DIVERTER AND HAND SHOWER

parti esterne / external parts: 4800/1/P/E  
parte incasso / built-in part: 724027



**4800/1/PQ/E + 724027 | JEANS** pag. 437

MISCELATORE INCASSO C/DEVIATORE E DOCCINO  
BUILT-IN MIXER WITH DIVERTER AND HAND SHOWER

parti esterne / external parts: 4800/1/PQ/E  
parte incasso / built-in part: 724027



**7800/1/P/E + 724027 | JQ** pag. 437

MISCELATORE INCASSO C/DEVIATORE E DOCCINO  
BUILT-IN MIXER WITH DIVERTER AND HAND SHOWER

parti esterne / external parts: 7800/1/P/E  
parte incasso / built-in part: 724027

**DEVIATORI INCASSO**



**4803/2/1/E + 914016 | JEANS** pag. 438

DEVIATORE INCASSO 2 USCITE  
BUILT-IN DIVERTER 2 OUT

parti esterne / external parts: 4803/2/1/E  
parte incasso / built-in part: 914016



**4803/2/1Q/E + 914016 | JEANS** pag. 438

DEVIATORE INCASSO 2 USCITE  
BUILT-IN DIVERTER 2 OUT

parti esterne / external parts: 4803/2/1Q/E  
parte incasso / built-in part: 914016



**7803/2/1/E + 914016 | JQ** pag. 438

DEVIATORE INCASSO 2 USCITE  
BUILT-IN DIVERTER 2 OUT

parti esterne / external parts: 7803/2/1/E  
parte incasso / built-in part: 914016



**4803/3/1/E + 034127 | JEANS** pag. 438

DEVIATORE INCASSO 3 USCITE  
BUILT-IN DIVERTER 3 OUT

parti esterne / external parts: 4803/3/1/E  
parte incasso / built-in part: 034127



**4803/3/1Q/E + 034127 | JEANS** pag. 438

DEVIATORE INCASSO 3 USCITE  
BUILT-IN DIVERTER 3 OUT

parti esterne / external parts: 4803/3/1Q/E  
parte incasso / built-in part: 034127



**7803/3/1/E + 034127 | JQ** pag. 439

DEVIATORE INCASSO 3 USCITE  
BUILT-IN DIVERTER 3 OUT

parti esterne / external parts: 7803/3/1/E  
parte incasso / built-in part: 034127



**4803/4/1/E + 034128 | JEANS** pag. 439

DEVIATORE INCASSO 4 USCITE  
BUILT-IN DIVERTER 4 OUT

parti esterne / external parts: 4803/4/1/E  
parte incasso / built-in part: 034128



**4803/4/1Q/E + 034128 | JEANS** pag. 439

DEVIATORE INCASSO 4 USCITE  
BUILT-IN DIVERTER 4 OUT

parti esterne / external parts: 4803/4/1Q/E  
parte incasso / built-in part: 034128



**7803/4/1/E + 034128 | JQ** pag. 439

DEVIATORE INCASSO 4 USCITE  
BUILT-IN DIVERTER 4 OUT

parti esterne / external parts: 7803/4/1/E  
parte incasso / built-in part: 034128

**DOCCIA INCASSO TERMOSTATICO**



**4812/P/E + 484020 | JEANS** pag. 255\*

MISCELATORE TERMOSTATICO INCASSO 1 USCITA  
BUILT-IN THERMOSTATIC MIXER 1 OUT

parti esterne / external parts: 4812/P/E  
parte incasso / built-in part: 484020



**4812/PQ/E + 484020 | JEANS** pag. 255\*

MISCELATORE TERMOSTATICO INCASSO 1 USCITA  
BUILT-IN THERMOSTATIC MIXER 1 OUT

parti esterne / external parts: 4812/PQ/E  
parte incasso / built-in part: 484020

\* ABBINAMENTO CONSIGLIATO: PER PREZZI E SCHEDE TECNICHE, VEDI RIFERIMENTO PAGINA LISTINO REVIVRE

\* RECOMMENDED COMBINATION: FOR PRICES AND TECHNICAL DETAILS, LOOK AT PAGE WITH REFERENCE REVIVRE PRICE



**DOCCIA INCASSO TERMOSTATICO**



**0912/H/P/E + 484020 | JQ** pag. 212\*

MISCELATORE TERMOSTATICO INCASSO 1 USCITA  
BUILT-IN THERMOSTATIC MIXER 1 OUT



parti esterne / external parts: 0912/H/P/E  
parte incasso / built-in part: 484020



**4812/2/P/E + 484021 | JEANS** pag. 255\*

MISCELATORE TERMOSTATICO INCASSO C/DEVIATORE 2 USCITE  
BUILT-IN THERMOSTATIC MIXER WITH DIVERTER 2 OUT



parti esterne / external parts: 4812/2/P/E  
parte incasso / built-in part: 484021



**4812/2/PQ/E + 484021 | JEANS** pag. 255\*

MISCELATORE TERMOSTATICO INCASSO C/DEVIATORE 2 USCITE  
BUILT-IN THERMOSTATIC MIXER WITH DIVERTER 2 OUT



parti esterne / external parts: 4812/2/PQ/E  
parte incasso / built-in part: 484021



**0912/2/P/E + 484021 | JQ** pag. 212\*

MISCELATORE TERMOSTATICO INCASSO C/DEVIATORE 2 USCITE  
BUILT-IN THERMOSTATIC MIXER WITH DIVERTER 2 OUT



parti esterne / external parts: 0912/2/P/E  
parte incasso / built-in part: 484021



**4812/3/P/E + 484022 | JEANS** pag. 256\*

MISCELATORE TERMOSTATICO INCASSO C/DEVIATORE 3 USCITE  
BUILT-IN THERMOSTATIC MIXER WITH DIVERTER 3 OUT



parti esterne / external parts: 4812/3/P/E  
parte incasso / built-in part: 484022



**4812/3/PQ/E + 484022 | JEANS** pag. 256\*

MISCELATORE TERMOSTATICO INCASSO C/DEVIATORE 3 USCITE  
BUILT-IN THERMOSTATIC MIXER WITH DIVERTER 3 OUT



parti esterne / external parts: 4812/3/PQ/E  
parte incasso / built-in part: 484022



**0912/3/P/E + 484022 | JQ** pag. 212\*

MISCELATORE TERMOSTATICO INCASSO C/DEVIATORE 3 USCITE  
BUILT-IN THERMOSTATIC MIXER WITH DIVERTER 3 OUT



parti esterne / external parts: 0912/3/P/E  
parte incasso / built-in part: 484022



**4812/4/P/E + 484023 | JEANS** pag. 256\*

MISCELATORE TERMOSTATICO INCASSO C/DEVIATORE 4 USCITE  
BUILT-IN THERMOSTATIC MIXER WITH DIVERTER 4 OUT



parti esterne / external parts: 4812/4/P/E  
parte incasso / built-in part: 484023



**4812/4/PQ/E + 484023 | JEANS** pag. 256\*

MISCELATORE TERMOSTATICO INCASSO C/DEVIATORE 4 USCITE  
BUILT-IN THERMOSTATIC MIXER WITH DIVERTER 4 OUT



parti esterne / external parts: 4812/4/PQ/E  
parte incasso / built-in part: 484023



**0912/4/P/E + 484023 | JQ** pag. 212\*

MISCELATORE TERMOSTATICO INCASSO C/DEVIATORE 4 USCITE  
BUILT-IN THERMOSTATIC MIXER WITH DIVERTER 4 OUT



parti esterne / external parts: 0912/4/P/E  
parte incasso / built-in part: 484023

**DOCCIA ESTERNO**



**4809/1 | JEANS** pag. 440

MISCELATORE DOCCIA ESTERNO  
EXTERNAL SHOWER MIXER



**7809/1 | JQ** pag. 440

MISCELATORE DOCCIA ESTERNO  
EXTERNAL SHOWER MIXER

**DOCCIA ESTERNO TERMOSTATICO**



**4811/1A | JEANS** pag. 440

MISCELATORE DOCCIA ESTERNO TERMOSTATICO  
EXTERNAL THERMOSTATIC SHOWER MIXER



**7811/1A | JQ** pag. 440

MISCELATORE DOCCIA ESTERNO TERMOSTATICO  
EXTERNAL THERMOSTATIC SHOWER MIXER

**DOCCIA COMPLEMENTI**



**4403/1/A | JEANS** pag. 134\*

SUPPORTO DOCCIA COMPLETO  
FULL SHOWER SUPPORT



**0903/1/A | JEANS** pag. 133\*

SUPPORTO DOCCIA COMPLETO  
FULL SHOWER SUPPORT

DOCCIA COMPLEMENTI



**6503/1/A | JQ** pag. 136\*  
SUPPORTO DOCCIA COMPLETO  
FULL SHOWER SUPPORT



**4403/1 | JEANS** pag. 135\*  
SUPPORTO DOCCIA DUPLEX COMPLETO  
DUPLEX FULL SHOWER SUPPORT



**0903/1 | JEANS** pag. 133\*  
SUPPORTO DOCCIA DUPLEX COMPLETO  
DUPLEX FULL SHOWER SUPPORT



**6503/1 | JQ** pag. 136\*  
SUPPORTO DOCCIA DUPLEX COMPLETO  
DUPLEX FULL SHOWER SUPPORT



**0530 | JEANS** pag. 140\*  
SALISCENDI COMPLETO C/PRESA D'ACQUA  
COMPLETE WALL PIPE WITH WATER CONNECTION



**7930 | JQ** pag. 144\*  
SALISCENDI COMPLETO C/PRESA D'ACQUA  
COMPLETE WALL PIPE WITH WATER CONNECTION



**0530/1 | JEANS** pag. 145\*  
ASTA SALISCENDI  
WALL PIPE



**7730/1 | JQ** pag. 148\*  
ASTA SALISCENDI  
WALL PIPE

VASCA



**4801/A | JEANS** pag. 440  
MISCELATORE VASCA ESTERNO  
EXTERNAL BATH MIXER



**7801/A | JQ** pag. 441  
MISCELATORE VASCA ESTERNO  
EXTERNAL BATH MIXER

NEW



**4801/2/A | JEANS** pag. 441  
MISCELATORE PER BORDO VASCA  
BATH RIM MIXER

NEW



**7801/2/A | JQ** pag. 441  
MISCELATORE PER BORDO VASCA  
BATH RIM MIXER



**4800/2/P/E + 724028 | JEANS** pag. 441  
MISCELATORE INCASSO C/DEVIATORE, DOCCINO  
E BOCCA  
BUILT-IN MIXER WITH DIVERTER HAND SHOWER  
AND SPOUT



**4800/2/PQ/E + 724028 | JEANS** pag. 441  
MISCELATORE INCASSO C/DEVIATORE, DOCCINO  
E BOCCA  
BUILT-IN MIXER WITH DIVERTER HAND SHOWER  
AND SPOUT



parti esterne / external parts: 4800/2/P/E  
parte incasso / built-in part: 724028



parti esterne / external parts: 4800/2/PQ/E  
parte incasso / built-in part: 724028



**7800/2/P/E + 724028 | JQ** pag. 442  
MISCELATORE INCASSO C/DEVIATORE, DOCCINO  
E BOCCA  
BUILT-IN MIXER WITH DIVERTER HAND SHOWER  
AND SPOUT



parti esterne / external parts: 7800/2/P/E  
parte incasso / built-in part: 724028

NEW



**4801/4/A/E + 734012 | JEANS** pag. 442  
MISCELATORE VASCA C/ATTACCHI A PAVIMENTO  
FLOOR BATH MIXER

parti esterne / external parts: 4801/4/A/E  
parte incasso / built-in part: 734012

\* ABBINAMENTO CONSIGLIATO: PER PREZZI E SCHEDE TECNICHE, VEDI RIFERIMENTO PAGINA LISTINO REVIVRE

\* RECOMMENDED COMBINATION: FOR PRICES AND TECHNICAL DETAILS, LOOK AT PAGE WITH REFERENCE REVIVRE PRICE

VASCA

NEW



7801/4/A/E + 734012 | JQ pag. 442

MISCELATORE VASCA C/ATTACCHI A PAVIMENTO  
FLOOR BATH MIXER

parti esterne / external parts: 7801/4/A/E  
parte incasso / built-in part: 734012



4803 | JEANS pag. 442

BOCCA VASCA DA PARETE  
WALL BATH SPOUT

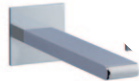

4803/Q | JEANS e JQ pag. 442

BOCCA VASCA DA PARETE  
WALL BATH SPOUT

BAGNO COMPLEMENTI



4808/E + 054025 o 054026 | JEANS pag. 443

RUBINETTO D'ARRESTO 1/2"  
BUILT-IN STOP COCK 1/2"



parti esterne / external parts: 4808/E  
parte incasso / built-in part: 054025 DX o 054026 SX



4808/Q/E + 054025 o 054026 | JEANS pag. 443

RUBINETTO D'ARRESTO 1/2"  
BUILT-IN STOP COCK 1/2"



parti esterne / external parts: 4808/Q/E  
parte incasso / built-in part: 054025 DX o 054026 SX



7808/E + 054025 o 054026 | JQ pag. 443

RUBINETTO D'ARRESTO 1/2"  
BUILT-IN STOP COCK 1/2"



parti esterne / external parts: 7808/E  
parte incasso / built-in part: 054025 DX o 054026 SX



4808/E + 054027 o 054028 | JEANS pag. 443

RUBINETTO D'ARRESTO 3/4"  
BUILT-IN STOP COCK 3/4"



parti esterne / external parts: 4808/E  
built-in part: 054027 DX o 054028 SX



4808/Q/E + 054027 o 054028 | JEANS pag. 443

RUBINETTO D'ARRESTO 3/4"  
BUILT-IN STOP COCK 3/4"



parti esterne / external parts: 4808/Q/E  
built-in part: 054027 DX o 054028 SX



7808/E + 054027 o 054028 | JQ pag. 444

RUBINETTO D'ARRESTO 3/4"  
BUILT-IN STOP COCK 3/4"



parti esterne / external parts: 7808/E  
built-in part: 054027 DX o 054028 SX



4840/E + 654099 | JEANS pag. 444

PASSO RAPIDO 3/4"  
BUILT-IN RAPID FLOW COCK 3/4"



parti esterne / external parts: 4840/E  
parte incasso / built-in part: 654099



4840/Q/E + 654099 | JEANS pag. 444

PASSO RAPIDO 3/4"  
BUILT-IN RAPID FLOW COCK 3/4"

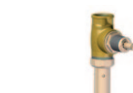

parti esterne / external parts: 4840/Q/E  
parte incasso / built-in part: 654099



7840/E + 654099 | JQ pag. 444

PASSO RAPIDO 3/4"  
BUILT-IN RAPID FLOW COCK 3/4"



parti esterne / external parts: 7840/E  
parte incasso / built-in part: 654099



4840/E + 654100 | JEANS pag. 444

PASSO RAPIDO 1"  
BUILT-IN RAPID FLOW COCK 1"



parti esterne / external parts: 4840/E  
parte incasso / built-in part: 654100



4840/Q/E + 654100 | JEANS pag. 445

PASSO RAPIDO 1"  
BUILT-IN RAPID FLOW COCK 1"



parti esterne / external parts: 4840/Q/E  
parte incasso / built-in part: 654100



7840/E + 654100 | JQ pag. 445

PASSO RAPIDO 1"  
BUILT-IN RAPID FLOW COCK 1"



parti esterne / external parts: 7840/E  
parte incasso / built-in part: 654100

## BAGNO COMPLEMENTI

**4832/2/E + 035212 | JEANS** pag. 445SARACINESCA  
GATE VALVEparti esterne / external parts: 4832/2/E  
parte incasso / built-in part: 035212**4832/2/Q/E + 035212 | JEANS** pag. 445SARACINESCA  
GATE VALVEparti esterne / external parts: 4832/2/Q/E  
parte incasso / built-in part: 035212**7832/2/E + 035212 | JQ** pag. 445SARACINESCA  
GATE VALVEparti esterne / external parts: 7832/2/E  
parte incasso / built-in part: 035212





## 7805/P - 7805/PR | JQ

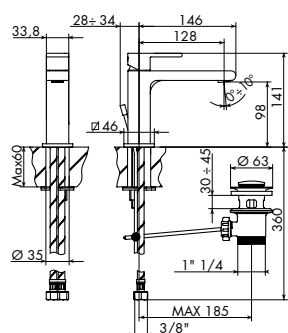

## MISCELATORE LAVABO MONOFORO BOCCA PROLUNGATA

- > cartuccia tradizionale
- > interasse bocca 128
- > aeratore orientabile
- > flessibili di alimentazione
- > con scarico

per art. 7805/PR:  
+ sistema a risparmio energetico, info pag. 419  
+ limitatore di portata 5l/min 3bar



	735005	p. 150
	785014	p. 142
	785016 ECO	p. 142

## CROMATO

01-7805/P

01-7805/PR

## ALTRE FINITURE

XX-7805/P

x M\*

XX-7805/PR

x M\*

## 4805/P/S - 4805/P/SR | JEANS

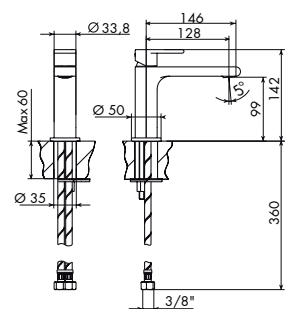

## MISCELATORE LAVABO MONOFORO BOCCA PROLUNGATA

- > cartuccia tradizionale
- > interasse bocca 128
- > flessibili di alimentazione
- > senza scarico

per art. 4805/P/SR:  
+ sistema a risparmio energetico, info pag. 419  
+ limitatore di portata 5l/min 3bar  
+ aeratore orientabile



	0136 - 0136/1	p. 717
	735005	p. 150
	725007	p. 141
	785016 ECO	p. 142

## CROMATO

01-4805/P/S

01-4805/P/SR

## ALTRE FINITURE

XX-4805/P/S

x M\*

XX-4805/P/SR

x M\*

## 7805/P/S - 7805/P/SR | JQ

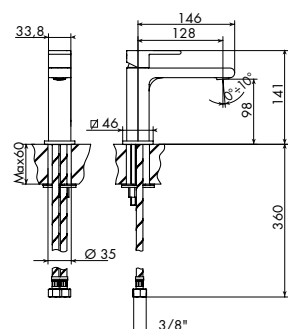

## MISCELATORE LAVABO MONOFORO BOCCA PROLUNGATA

- > cartuccia tradizionale
- > interasse bocca 128
- > aeratore orientabile
- > flessibili di alimentazione
- > senza scarico

per art. 7805/P/SR:  
+ sistema a risparmio energetico, info pag. 419  
+ limitatore di portata 5l/min 3bar



	6536 - 6536/1	p. 720
	735005	p. 150
	785014	p. 142
	785016 ECO	p. 142

## CROMATO

01-7805/P/S

01-7805/P/SR

## ALTRE FINITURE

XX-7805/P/S

x M\*

XX-7805/P/SR

x M\*

## 4805/PN - 4805/PRN | JEANS

NEW

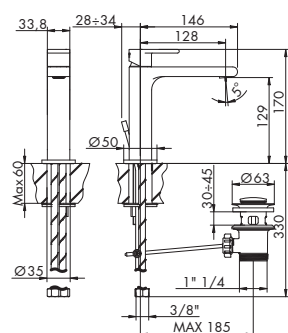

## MISCELATORE LAVABO MEDIUM MONOFORO BOCCA PROLUNGATA

- > cartuccia tradizionale
- > interasse bocca 128
- > flessibili di alimentazione
- > con scarico

per art. 4805/PRN:  
+ sistema a risparmio energetico, info pag. 419  
+ limitatore di portata 5l/min 3bar  
+ aeratore orientabile



	735005	p. 150
	725007	p. 141
	785016 ECO	p. 142

## CROMATO

01-4805/PN

01-4805/PRN

## ALTRE FINITURE

XX-4805/PN

x M\*

XX-4805/PRN

x M\*

## 7805/PN - 7805/PRN | JQ

NEW

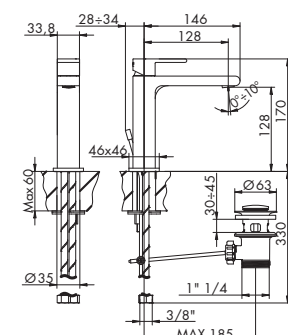

## MISCELATORE LAVABO MEDIUM MONOFORO BOCCA PROLUNGATA

- > cartuccia tradizionale
- > interasse bocca 128
- > aeratore orientabile
- > flessibili di alimentazione
- > con scarico

per art. 7805/PRN:  
+ sistema a risparmio energetico, info pag. 419  
+ limitatore di portata 5l/min 3bar



	735005	p. 150
	785014	p. 142
	785016 ECO	p. 142

## CROMATO

01-7805/PN

01-7805/PRN

## ALTRE FINITURE

XX-7805/PN

x M\*

XX-7805/PRN

x M\*

## ACCESSORI



SCARICO C/TAPPO A PRESSIONE

## RICAMBI IMMEDIATI



CARTUCCIA



AERATORE TONDO

XX = CODICE FINITURA RICHIESTA: per identificare codice corretto vedi pag. 418  
M\* = MOLTIPLICATORE: per calcolare il prezzo delle altre finiture vedi tabella pag. 418

4805/P/SN - 4805/P/SRN | JEANS

NEW

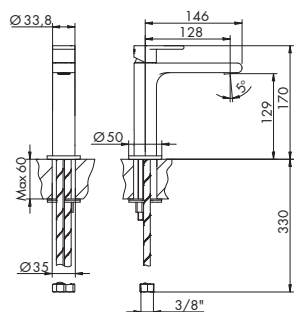

MISCELATORE LAVABO MEDIUM MONOFORO BOCCA  
PROLUNGATA

- > cartuccia tradizionale
- > interasse bocca 128
- > flessibili di alimentazione
- > senza scarico

per art. 4805/P/SRN:  
+ sistema a risparmio energetico, info pag. 419  
+ limitatore di portata 5l/min 3bar  
+ aeratore orientabile



- 0136 - 0136/1 p. 717
- 735005 p. 150
- 725007 p. 141
- 785016 ECO p. 142

CROMATO

- 01-4805/P/SN
- 01-4805/P/SRN

ALTRE FINITURE

- XX-4805/P/SN x M\*
- XX-4805/P/SRN x M\*

7805/P/SN - 7805/P/SRN | JQ

NEW

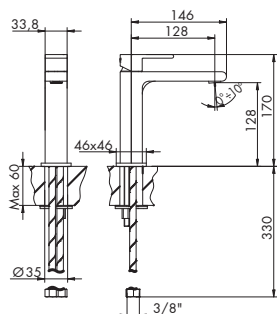

MISCELATORE LAVABO MEDIUM MONOFORO BOCCA  
PROLUNGATA

- > cartuccia tradizionale
- > interasse bocca 128
- > aeratore orientabile
- > flessibili di alimentazione
- > senza scarico

per art. 7805/P/SRN:  
+ sistema a risparmio energetico, info pag. 419  
+ limitatore di portata 5l/min 3bar



- 6536 - 6536/1 p. 720
- 735005 p. 150
- 785014 p. 142
- 785016 ECO p. 142

CROMATO

- 01-7805/P/SN
- 01-7805/P/SRN

ALTRE FINITURE

- XX-7805/P/SN x M\*
- XX-7805/P/SRN x M\*

4805/P/A - 4805/P/AR | JEANS

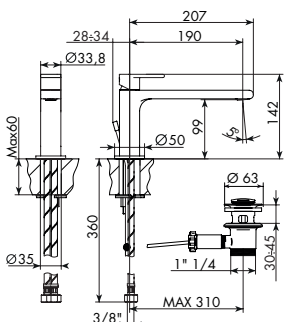

MISCELATORE LAVABO MONOFORO BOCCA  
EXTRAPROLUNGATA

- > cartuccia tradizionale
- > interasse bocca 190
- > flessibili di alimentazione
- > con scarico

per art. 4805/P/AR:  
+ sistema a risparmio energetico, info pag. 419  
+ limitatore di portata 5l/min 3bar  
+ aeratore orientabile



- 735005 p. 150
- 725007 p. 141
- 785016 ECO p. 142

CROMATO

- 01-4805/P/A
- 01-4805/P/AR

ALTRE FINITURE

- XX-4805/P/A x M\*
- XX-4805/P/AR x M\*

7805/P/A - 7805/P/AR | JQ

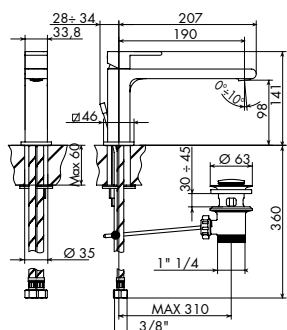

MISCELATORE LAVABO MONOFORO BOCCA  
EXTRAPROLUNGATA

- > cartuccia tradizionale
- > interasse bocca 190
- > aeratore orientabile
- > flessibili di alimentazione
- > con scarico

per art. 7805/P/AR:  
+ sistema a risparmio energetico, info pag. 419  
+ limitatore di portata 5l/min 3bar



- 735005 p. 150
- 785014 p. 142
- 785016 ECO p. 142

CROMATO

- 01-7805/P/A
- 01-7805/P/AR

ALTRE FINITURE

- XX-7805/P/A x M\*
- XX-7805/P/AR x M\*

4805/P/A/S - 4805/P/A/SR | JEANS

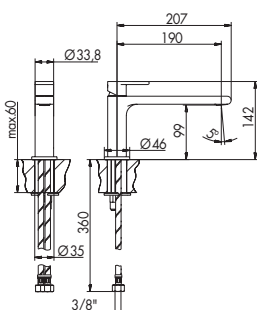

MISCELATORE LAVABO MONOFORO BOCCA  
EXTRAPROLUNGATA

- > cartuccia tradizionale
- > interasse bocca 190
- > flessibili di alimentazione
- > senza scarico

per art. 4805/P/A/SR:  
+ sistema a risparmio energetico, info pag. 419  
+ limitatore di portata 5l/min 3bar  
+ aeratore orientabile



- 0136 - 0136/1 p. 717
- 735005 p. 150
- 725007 p. 141
- 785016 ECO p. 142

CROMATO

- 01-4805/P/A/S
- 01-4805/P/A/SR

ALTRE FINITURE

- XX-4805/P/A/S x M\*
- XX-4805/P/A/SR x M\*







## 4805/1 - 4805/1R | JEANS

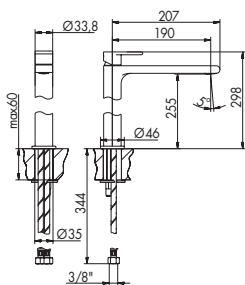

## MISCELATORE LAVABO MONOFORO ALTO BOCCA PROLUNGATA

- > cartuccia tradizionale
- > interasse bocca 190
- > flessibili di alimentazione
- > prolungabili con art. 484005, 484006, 484007
- > senza scarico

per art. 4805/1R:  
+ sistema a risparmio energetico, info pag. 419  
+ limitatore di portata 5l/min 3bar  
+ aeratore orientabile



	0136 - 0136/1	p. 717
	735005	p. 150
	725007	p. 141
	785016 ECO	p. 142

## CROMATO

01-4805/1  
01-4805/1R

## ALTRE FINITURE

XX-4805/1 x M\*  
XX-4805/1R x M\*

## 7805/1 - 7805/1R | JQ

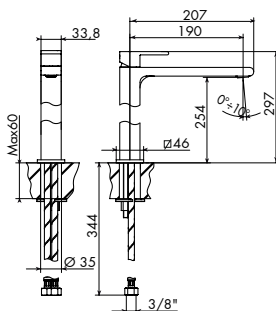

## MISCELATORE LAVABO MONOFORO ALTO BOCCA PROLUNGATA

- > cartuccia tradizionale
- > interasse bocca 190
- > aeratore orientabile
- > flessibili di alimentazione
- > prolungabili con art. 784003, 784004, 784005
- > senza scarico

per art. 7805/1R:  
+ sistema a risparmio energetico, info pag. 419  
+ limitatore di portata 5l/min 3bar



	6536 - 6536/1	p. 720
	735005	p. 150
	785014	p. 142
	785016 ECO	p. 142

## CROMATO

01-7805/1  
01-7805/1R

## ALTRE FINITURE

XX-7805/1 x M\*  
XX-7805/1R x M\*

## 4805/3/A/E + 894001 | JEANS

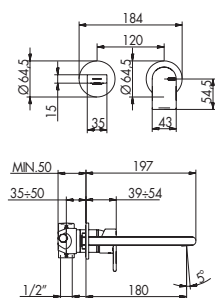

## MISCELATORE LAVABO DA PARETE

- > cartuccia tradizionale
- > interasse bocca 180
- > ingressi da 1/2"
- > senza scarico
- > rosoni separati

	0136 - 0136/1	p. 717
	025002	p. 149
	725007	p. 141

## PARTI ESTERNE - CROMATO

01-4805/3/A/E

## PARTE INCASSO

01-894001 info pag. 34

## PREZZO TOTALE

## PARTI ESTERNE - ALTRE FINITURE

XX-4805/3/A/E x M\*

## 4805/3/AQ/E + 894001 | JEANS

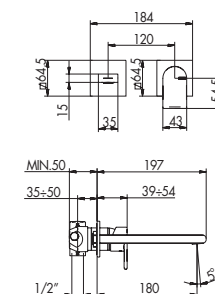
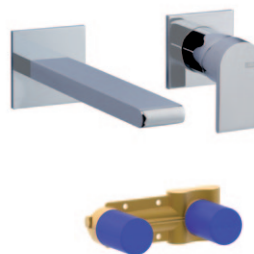

## MISCELATORE LAVABO DA PARETE

- > cartuccia tradizionale
- > interasse bocca 180
- > ingressi da 1/2"
- > senza scarico
- > rosoni separati quadri

	6536 - 6536/1	p. 720
	025002	p. 149
	725007	p. 141

## PARTI ESTERNE - CROMATO

01-4805/3/AQ/E

## PARTE INCASSO

01-894001 info pag. 34

## PREZZO TOTALE

## PARTI ESTERNE - ALTRE FINITURE

XX-4805/3/AQ/E x M\*

## 7805/3/A/E + 894001 | JQ

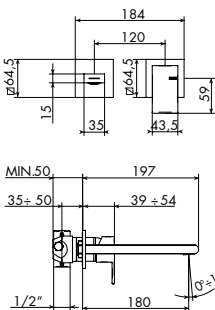

## MISCELATORE LAVABO DA PARETE

- > cartuccia tradizionale
- > interasse bocca 180
- > aeratore orientabile
- > ingressi da 1/2"
- > senza scarico
- > rosoni separati

	6536 - 6536/1	p. 720
	025002	p. 149
	785014	p. 142

## PARTI ESTERNE - CROMATO

01-7805/3/A/E

## PARTE INCASSO

01-894001 info pag. 34

## PREZZO TOTALE

## PARTI ESTERNE - ALTRE FINITURE

XX-7805/3/A/E x M\*

## 4805/3/B/E + 894001 | JEANS

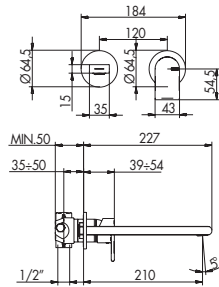

## MISCELATORE LAVABO DA PARETE

- > cartuccia tradizionale
- > interasse bocca 210
- > ingressi da 1/2"
- > senza scarico
- > rosoni separati

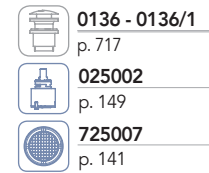

## PARTI ESTERNE - CROMATO

01-4805/3/B/E

## PARTE INCASSO

01-894001 info pag. 34

## PREZZO TOTALE

## PARTI ESTERNE - ALTRE FINITURE

XX-4805/3/B/E

x M\*

## 4805/3/BQ/E + 894001 | JEANS

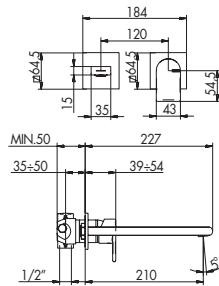

## MISCELATORE LAVABO DA PARETE BOCCA PROLUNGATA

- > cartuccia tradizionale
- > interasse bocca 210
- > ingressi da 1/2"
- > senza scarico
- > rosoni separati quadri

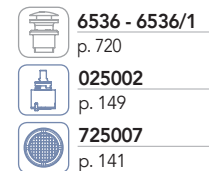

## PARTI ESTERNE - CROMATO

01-4805/3/BQ/E

## PARTE INCASSO

01-894001 info pag. 34

## PREZZO TOTALE

## PARTI ESTERNE - ALTRE FINITURE

XX-4805/3/BQ/E

x M\*

## 7805/3/B/E + 894001 | JQ

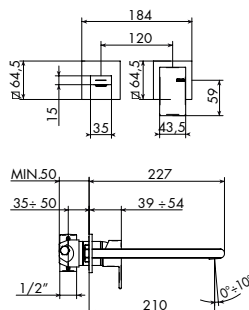

## MISCELATORE LAVABO DA PARETE BOCCA PROLUNGATA

- > cartuccia tradizionale
- > interasse bocca 210
- > aeratore orientabile
- > ingressi da 1/2"
- > senza scarico
- > rosoni separati

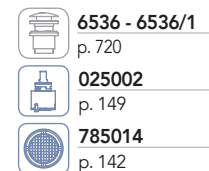

## PARTI ESTERNE - CROMATO

01-7805/3/B/E

## PARTE INCASSO

01-894001 info pag. 34

## PREZZO TOTALE

## PARTI ESTERNE - ALTRE FINITURE

XX-7805/3/B/E

x M\*

## 4805/3/E + 894001 | JEANS

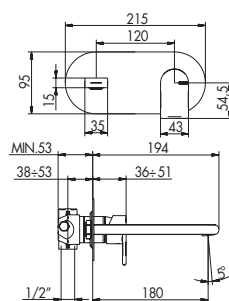

## MISCELATORE LAVABO DA PARETE SU PIASTRA

- > cartuccia tradizionale
- > interasse bocca 180
- > ingressi da 1/2"
- > senza scarico
- > piastra unica



## PARTI ESTERNE - CROMATO

01-4805/3/E

## PARTE INCASSO

01-894001 info pag. 34

## PREZZO TOTALE

## PARTI ESTERNE - ALTRE FINITURE

XX-4805/3/E

x M\*

## 4805/3Q/E + 894001 | JEANS

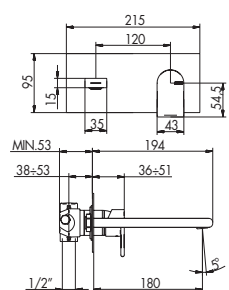

## MISCELATORE LAVABO DA PARETE SU PIASTRA

- > cartuccia tradizionale
- > interasse bocca 180
- > ingressi da 1/2"
- > senza scarico
- > piastra unica rettangolare

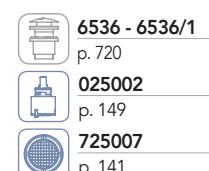

## PARTI ESTERNE - CROMATO

01-4805/3Q/E

## PARTE INCASSO

01-894001 info pag. 34

## PREZZO TOTALE

## PARTI ESTERNE - ALTRE FINITURE

XX-4805/3Q/E

x M\*

## ACCESSORI



## RICAMBI IMMEDIATI



XX = CODICE FINITURA RICHIESTA: per identificare codice corretto vedi pag. 418  
 M\* = MOLTIPLICATORE: per calcolare il prezzo delle altre finiture vedi tabella pag. 418

## 7805/3/E + 894001 | JQ

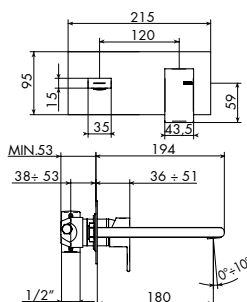

## MISCELATORE LAVABO DA PARETE SU PIASTRA

- > cartuccia tradizionale
- > interasse bocca 180
- > aeratore orientabile
- > ingressi da 1/2"
- > senza scarico
- > piastra unica



## PARTI ESTERNE - CROMATO

01-7805/3/E

## PARTE INCASSO

01-894001 info pag. 34

## PREZZO TOTALE

## PARTI ESTERNE - ALTRE FINITURE

XX-7805/3/E

x M\*

## 4805/3/1/E + 894001 | JEANS

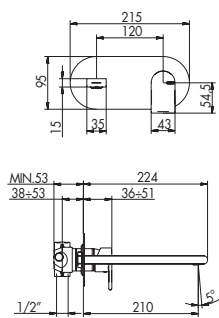

## MISCELATORE LAVABO DA PARETE BOCCA PROLUNGATA SU PIASTRA

- > cartuccia tradizionale
- > interasse bocca 210
- > ingressi da 1/2"
- > senza scarico
- > piastra unica



## PARTI ESTERNE - CROMATO

01-4805/3/1/E

## PARTE INCASSO

01-894001 info pag. 34

## PREZZO TOTALE

## PARTI ESTERNE - ALTRE FINITURE

XX-4805/3/1/E

x M\*

## 4805/3/1Q/E + 894001 | JEANS

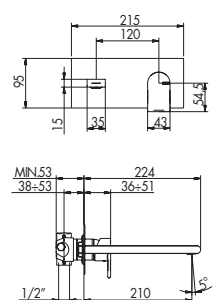
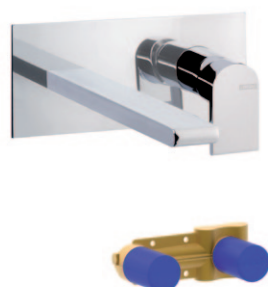

## MISCELATORE LAVABO DA PARETE BOCCA PROLUNGATA SU PIASTRA

- > cartuccia tradizionale
- > interasse bocca 210
- > ingressi da 1/2"
- > senza scarico
- > piastra unica



## PARTI ESTERNE - CROMATO

01-4805/3/1Q/E

## PARTE INCASSO

01-894001 info pag. 34

## PREZZO TOTALE

## PARTI ESTERNE - ALTRE FINITURE

XX-4805/3/1Q/E

x M\*

## 7805/3/1/E + 894001 | JQ

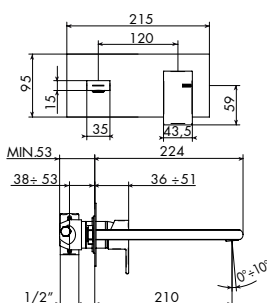

## MISCELATORE LAVABO DA PARETE BOCCA PROLUNGATA SU PIASTRA

- > cartuccia tradizionale
- > interasse bocca 210
- > aeratore orientabile
- > ingressi da 1/2"
- > senza scarico
- > piastra unica



## PARTI ESTERNE - CROMATO

01-7805/3/1/E

## PARTE INCASSO

01-894001 info pag. 34

## PREZZO TOTALE

## PARTI ESTERNE - ALTRE FINITURE

XX-7805/3/1/E

x M\*

## 4805/R/A | JEANS

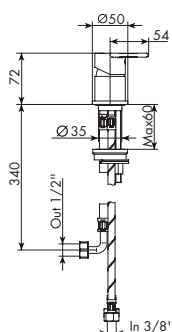

## MISCELATORE REMOTO

- > cartuccia tradizionale
- > flessibili di alimentazione
- > senza scarico

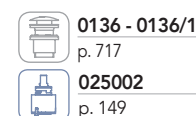

## CROMATO

01-4805/R/A

## ALTRE FINITURE

XX-4805/R/A

x M\*

## 7805/R/A | JQ

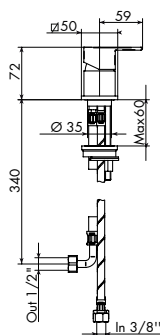

## MISCELATORE REMOTO

- > cartuccia tradizionale
- > flessibili di alimentazione
- > senza scarico

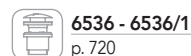

CROMATO  
01-7805/R/A

ALTRE FINITURE  
XX-7805/R/A

x M\*

## 4805/R/B/E + 104033 | JEANS

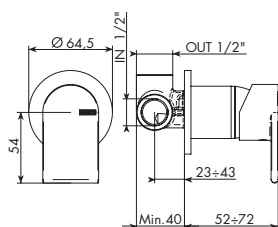

## MISCELATORE INCASSO REMOTO

- > cartuccia tradizionale
- > ingressi da 1/2"
- > uscita superiore
- > senza scarico

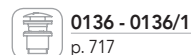

PARTI ESTERNE - CROMATO  
01-4805/R/B/E

PARTI ESTERNE - ALTRE FINITURE  
XX-4805/R/B/E

x M\*

PARTE INCASSO  
01-104033 info pag. 32

PREZZO TOTALE

## 4805/R/BQ/E + 104033 | JEANS

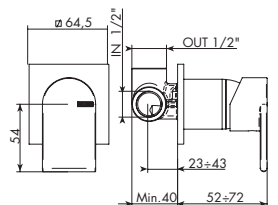

## MISCELATORE INCASSO REMOTO

- > cartuccia tradizionale
- > ingressi da 1/2"
- > uscita superiore
- > senza scarico
- > rosone quadro

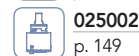
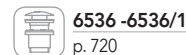

PARTI ESTERNE - CROMATO  
01-4805/R/BQ/E

PARTI ESTERNE - ALTRE FINITURE  
XX-4805/R/BQ/E

x M\*

PARTE INCASSO  
01-104033 info pag. 32

PREZZO TOTALE

## 7805/R/B/E + 104033 | JQ

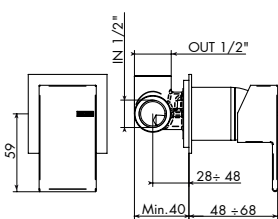

## MISCELATORE INCASSO REMOTO

- > cartuccia tradizionale
- > ingressi da 1/2"
- > uscita superiore
- > senza scarico

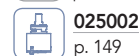
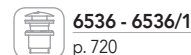

PARTI ESTERNE - CROMATO  
01-7805/R/B/E

PARTI ESTERNE - ALTRE FINITURE  
XX-7805/R/B/E

x M\*

PARTE INCASSO  
01-104033 info pag. 32

PREZZO TOTALE

## 4807 - 4807/R | JEANS

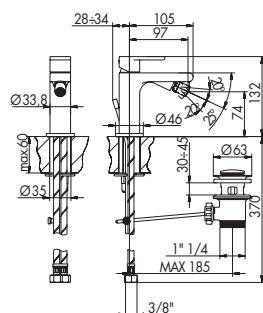

## MISCELATORE BIDET MONOFORO

- > cartuccia tradizionale
- > interasse bocca 97
- > aeratore snodato
- > flessibili di alimentazione
- > con scarico



per art. 4807/R:

+ sistema a risparmio energetico, info pag. 419



CROMATO

01-4807  
01-4807/R

ALTRE FINITURE

XX-4807  
XX-4807/R

x M\*

x M\*

## ACCESSORI



## RICAMBI IMMEDIATI



XX = CODICE FINITURA RICHIESTA: per identificare codice corretto vedi pag. 418  
M\* = MULTIPLICATORE: per calcolare il prezzo delle altre finiture vedi tabella pag. 418



7807 - 7807/R | JQ

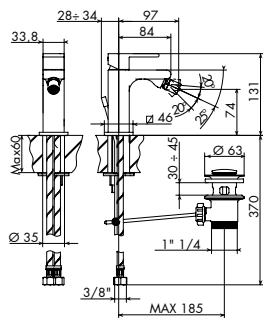

MISCELATORE BIDET MONOFORO

- > cartuccia tradizionale
- > interasse bocca 97
- > aeratore snodato
- > flessibili di alimentazione
- > con scarico

per art. 7807/R:  
+ sistema a risparmio energetico, info pag. 419



	735005
	p. 150
	445017
	p. 141

CROMATO	ALTRE FINITURE
01-7807	XX-7807 x M*
01-7807/R	XX-7807/R x M*

4821/N/E + 104018 | JEANS

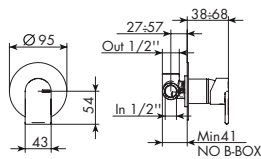

MISCELATORE INCASSO

- > cartuccia tradizionale
- > ingressi da 1/2"
- > uscita superiore
- > incasso c/b-box

	025002
	p. 149

PARTI ESTERNE - CROMATO	PARTI ESTERNE - ALTRE FINITURE
01-4821/N/E	XX-4821/N/E x M*
PARTE INCASSO	
01-104018	info pag. 36
PREZZO TOTALE	

4821/Q/E + 104018 | JEANS

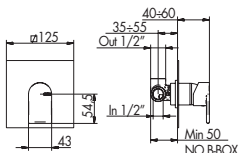

MISCELATORE INCASSO

- > cartuccia tradizionale
- > ingressi da 1/2"
- > uscita superiore
- > incasso c/b-box
- > piastra quadra

	025002
	p. 149

PARTI ESTERNE - CROMATO	PARTI ESTERNE - ALTRE FINITURE
01-4821/Q/E	XX-4821/Q/E x M*
PARTE INCASSO	
01-104018	info pag. 36
PREZZO TOTALE	

7821/E + 104018 | JQ

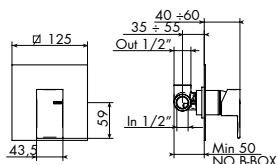

MISCELATORE INCASSO

- > cartuccia tradizionale
- > ingressi da 1/2"
- > uscita superiore
- > incasso c/b-box

	025002
	p. 149

PARTI ESTERNE - CROMATO	PARTI ESTERNE - ALTRE FINITURE
01-7821/E	XX-7821/E x M*
PARTE INCASSO	
01-104018	info pag. 36
PREZZO TOTALE	

4800/E + 104002 | JEANS

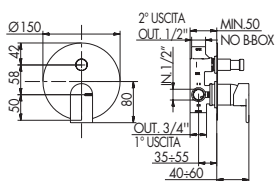

MISCELATORE INCASSO C/DEVIATORE 2 USCITE

- > cartuccia tradizionale
- > deviatore a pressione 2 uscite c/ritorno automatico e blocco meccanico basse pressioni
- > attacchi da 1/2"
- > uscita principale inferiore da 3/4"
- > incasso c/b-box

	025002
	p. 149

	105029
	p. 131

PARTI ESTERNE - CROMATO	PARTI ESTERNE - ALTRE FINITURE
01-4800/E	XX-4800/E x M*
PARTE INCASSO	
01-104002	info pag. 37
PREZZO TOTALE	

## 4800/Q/E + 104002 | JEANS

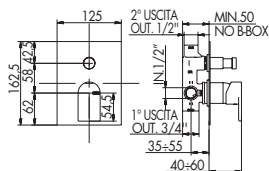

## MISCELATORE INCASSO C/DEVIATORE 2 USCITE

- > cartuccia tradizionale
- > deviatore a pressione 2 uscite c/ritorno automatico e blocco meccanico basse pressioni
- > piastra rettangolare
- > uscita principale inferiore da 3/4"
- > incasso c/b-box
- > attacchi da 1/2"



025002

p. 149



105029

p. 131

## PARTI ESTERNE - CROMATO

01-4800/Q/E

## PARTI ESTERNE - ALTRE FINITURE

XX-4800/Q/E

x M\*

## PARTE INCASSO

01-104002 info pag. 37

## PREZZO TOTALE

## 7800/E + 104002 | JQ

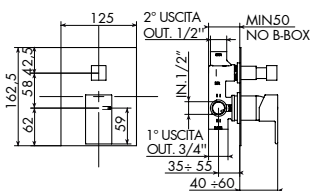

## MISCELATORE INCASSO C/DEVIATORE 2 USCITE

- > cartuccia tradizionale
- > deviatore a pressione 2 uscite c/ritorno automatico e blocco meccanico basse pressioni
- > uscita principale inferiore da 3/4"
- > incasso c/b-box
- > attacchi da 1/2"



025002

p. 149



105029

p. 131

## PARTI ESTERNE - CROMATO

01-7800/E

## PARTI ESTERNE - ALTRE FINITURE

XX-7800/E

x M\*

## PARTE INCASSO

01-104002 info pag. 37

## PREZZO TOTALE

## 4800/1/P/E + 724027 | JEANS

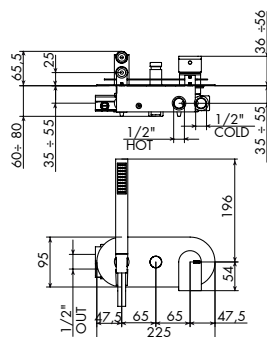

## MISCELATORE INCASSO C/DEVIATORE E DOCCINO

- > cartuccia tradizionale
- > deviatore a pressione 2 uscite c/ritorno automatico e blocco meccanico basse pressioni
- > attacchi da 1/2" > flessibile PVC 150 cm
- > uscita principale fianco sinistro
- > doccetta monogetto cilindrica in ABS c/anticalcare, per finiture diverse da cromo doccetta in metallo



025002

p. 149



724030

p. 132

## PARTI ESTERNE - CROMATO

01-4800/1/P/E

## PARTI ESTERNE - ALTRE FINITURE

XX-4800/1/P/E

x M\*

## PARTE INCASSO

01-724027 info pag. 38

## PREZZO TOTALE

## 4800/1/PQ/E + 724027 | JEANS

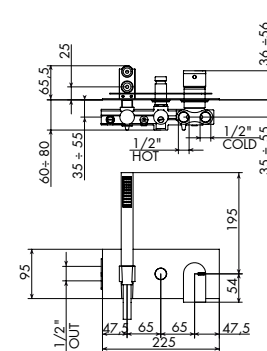

## MISCELATORE INCASSO C/DEVIATORE E DOCCINO

- > cartuccia tradizionale
- > deviatore a pressione 2 uscite c/ritorno automatico e blocco meccanico basse pressioni
- > piastra rettangolare
- > attacchi da 1/2" > flessibile PVC 150 cm
- > uscita principale fianco sinistro
- > doccetta monogetto cilindrica in ABS c/anticalcare, per finiture diverse da cromo doccetta in metallo



025002

p. 149



724030

p. 132

## PARTI ESTERNE - CROMATO

01-4800/1/PQ/E

## PARTI ESTERNE - ALTRE FINITURE

XX-4800/1/PQ/E

x M\*

## PARTE INCASSO

01-724027 info pag. 38

## PREZZO TOTALE

## 7800/1/P/E + 724027 | JQ

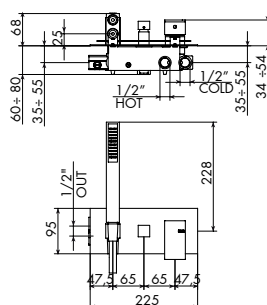

## MISCELATORE INCASSO C/DEVIATORE E DOCCINO

- > cartuccia tradizionale
- > deviatore a pressione 2 uscite c/ritorno automatico e blocco meccanico basse pressioni
- > attacchi da 1/2" > flessibile PVC 150 cm
- > uscita principale fianco sinistro
- > doccetta monogetto cilindrica in ABS c/anticalcare, per finiture diverse da cromo doccetta in metallo



025002

p. 149



724030

p. 132

## PARTI ESTERNE - CROMATO

01-7800/1/P/E

## PARTI ESTERNE - ALTRE FINITURE

XX-7800/1/P/E

x M\*

## PARTE INCASSO

01-724027 info pag. 38

## PREZZO TOTALE



4803/2/1/E + 914016 | JEANS

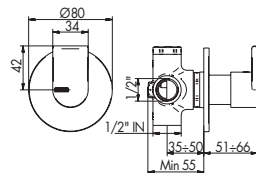
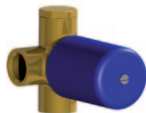

DEVIATORE INCASSO 2 USCITE

> deviatore a dischi ceramici 2 uscite senza chiusura  
> attacchi da 1/2"

**635010**  
p. 131  
 **035346** fino 9.2017  
p. 131

PARTI ESTERNE - CROMATO

01-4803/2/1/E

PARTI ESTERNE - ALTRE FINITURE

XX-4803/2/1/E

x M\*

PARTE INCASSO

914016 info pag. 38

PREZZO TOTALE

4803/2/1Q/E + 914016 | JEANS

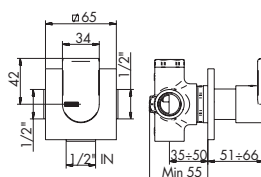
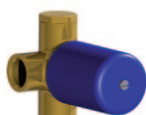

DEVIATORE INCASSO 2 USCITE

> deviatore a dischi ceramici 2 uscite senza chiusura  
> attacchi da 1/2"  
> rosone quadro

**635010**  
p. 131  
 **035346** fino 9.2017  
p. 131

PARTI ESTERNE - CROMATO

01-4803/2/1Q/E

PARTI ESTERNE - ALTRE FINITURE

XX-4803/2/1Q/E

x M\*

PARTE INCASSO

914016 info pag. 38

PREZZO TOTALE

7803/2/1/E + 914016 | JQ

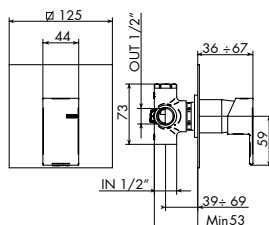
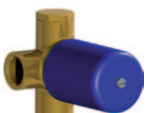

DEVIATORE INCASSO 2 USCITE

> deviatore a dischi ceramici 2 uscite senza chiusura  
> attacchi da 1/2"

**635010**  
p. 131  
 **035346** fino 9.2017  
p. 131

PARTI ESTERNE - CROMATO

01-7803/2/1/E

PARTI ESTERNE - ALTRE FINITURE

XX-7803/2/1/E

x M\*

PARTE INCASSO

914016 info pag. 38

PREZZO TOTALE

4803/3/1/E + 034127 | JEANS

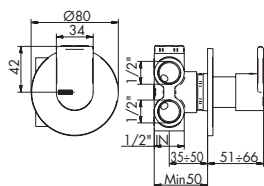
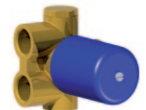

DEVIATORE INCASSO 3 USCITE

> deviatore a dischi ceramici 3 uscite senza chiusura  
> attacchi da 1/2"

**635011**  
p. 131  
 **035345** fino 9.2017  
p. 131

PARTI ESTERNE - CROMATO

01-4803/3/1/E

PARTI ESTERNE - ALTRE FINITURE

XX-4803/3/1/E

x M\*

PARTE INCASSO

034127 info pag. 38

PREZZO TOTALE

4803/3/1Q/E + 034127 | JEANS

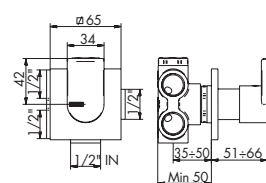

DEVIATORE INCASSO 3 USCITE

> deviatore a dischi ceramici 3 uscite senza chiusura  
> attacchi da 1/2"  
> rosone quadro

**635011**  
p. 131  
 **035345** fino 9.2017  
p. 131

PARTI ESTERNE - CROMATO

01-4803/3/1Q/E

PARTI ESTERNE - ALTRE FINITURE

XX-4803/3/1Q/E

x M\*

PARTE INCASSO

034127 info pag. 38

PREZZO TOTALE

7803/3/1/E + 034127 | JQ

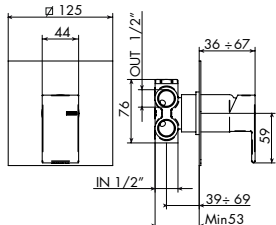
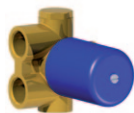

DEVIATORE INCASSO 3 USCITE

> deviatore a dischi ceramici 3 uscite senza chiusura  
> attacchi da 1/2"



635011

p. 131



035345 fino 9.2017

p. 131

PARTI ESTERNE - CROMATO

01-7803/3/1/E

PARTE INCASSO

034127 info pag. 38

PREZZO TOTALE

PARTI ESTERNE - ALTRE FINITURE

XX-7803/3/1/E

x M\*

4803/4/1/E + 034128 | JEANS

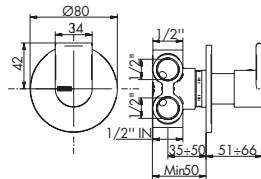
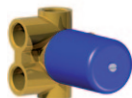

DEVIATORE INCASSO 4 USCITE

> deviatore a dischi ceramici 4 uscite senza chiusura  
> attacchi da 1/2"



635012

p. 131



035344 fino 9.2017

p. 131

PARTI ESTERNE - CROMATO

01-4803/4/1/E

PARTE INCASSO

034128 info pag. 38

PREZZO TOTALE

PARTI ESTERNE - ALTRE FINITURE

XX-4803/4/1/E

x M\*

4803/4/1Q/E + 034128 | JEANS

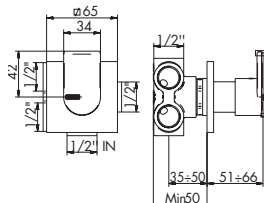
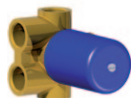

DEVIATORE INCASSO 4 USCITE

> deviatore a dischi ceramici 4 uscite senza chiusura  
> attacchi da 1/2"  
> rosone quadro



635012

p. 131



035344 fino 9.2017

p. 131

PARTI ESTERNE - CROMATO

01-4803/4/1Q/E

PARTE INCASSO

034128 info pag. 38

PREZZO TOTALE

PARTI ESTERNE - ALTRE FINITURE

XX-4803/4/1Q/E

x M\*

7803/4/1/E + 034128 | JQ

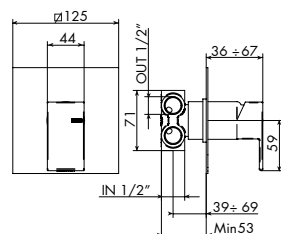
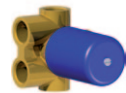

DEVIATORE INCASSO 4 USCITE

> deviatore a dischi ceramici 4 uscite senza chiusura  
> attacchi da 1/2"



635012

p. 131



035344 fino 9.2017

p. 131

PARTI ESTERNE - CROMATO

01-7803/4/1/E

PARTE INCASSO

034128 info pag. 38

PREZZO TOTALE

PARTI ESTERNE - ALTRE FINITURE

XX-7803/4/1/E

x M\*

I DOCCIA INCASSO TERMOSTATICO CONSIGLIATI SONO PRESENTI SU LISTINO REVIVRE

4812/P/E + 484020  
4812/2/P/E + 484021  
4812/3/P/E + 484022  
4812/4/P/E + 484023

4812/PQ/E + 484020  
4812/2/PQ/E + 484021  
4812/3/PQ/E + 484022  
4812/4/PQ/E + 484023

0912/H/P/E + 484020  
0912/2/P/E + 484021  
0912/3/P/E + 484022  
0912/4/P/E + 484023

I DOCCIA COMPLEMENTI CONSIGLIATI SONO PRESENTI SU LISTINO REVIVRE

4403/1/A  
0903/1/A  
6503/1/A  
4403/1

0903/1  
6503/1  
0530  
7930

0530/1  
7730/1



CARTUCCIA  
DEVIATRICE

## 4809/1 | JEANS

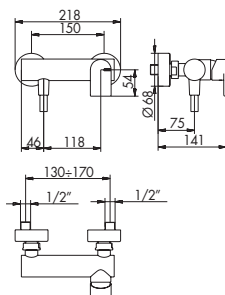

## MISCELATORE DOCCIA ESTERNO

- > cartuccia tradizionale
- > senza set doccia
- > attacchi da 1/2"

025002  
p. 149

CROMATO

01-4809/1

ALTRE FINITURE

XX-4809/1

x M\*

## 7809/1 | JQ

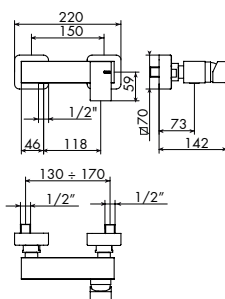

## MISCELATORE DOCCIA ESTERNO

- > cartuccia tradizionale
- > senza set doccia
- > attacchi da 1/2"

025002  
p. 149

CROMATO

01-7809/1

ALTRE FINITURE

XX-7809/1

x M\*

## 4811/1A | JEANS

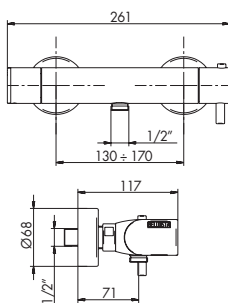

## MISCELATORE DOCCIA ESTERNO TERMOSTATICO

- > cartuccia termostatica
- > vitone ceramico 90°
- > senza set doccia
- > attacchi da 1/2"

885041  
p. 150055002  
p. 151

CROMATO

01-4811/1A

ALTRE FINITURE

XX-4811/1A

x M\*

## 7811/1A | JQ

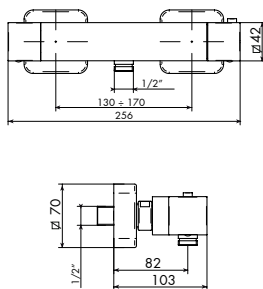

## MISCELATORE DOCCIA ESTERNO TERMOSTATICO

- > cartuccia termostatica
- > vitone ceramico 90°
- > senza set doccia
- > attacchi da 1/2"

885041  
p. 150055002  
p. 151

CROMATO

01-7811/1A

ALTRE FINITURE

XX-7811/1A

x M\*

## 4801/A | JEANS

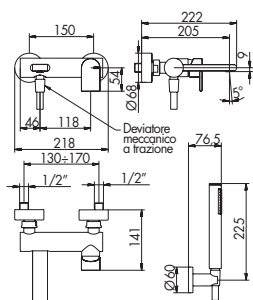

## MISCELATORE VASCA ESTERNO

- > cartuccia tradizionale
- > interasse bocca 205
- > deviatore a trazione/spinta senza ritorno automatico
- > flessibile in PVC 150 cm
- > supporto a parete fisso
- > attacchi da 1/2"
- > doccetta monogetto cilindrica in ABS c/anticalcare, per finiture diverse da cromo doccetta in metallo

025002  
p. 149654020  
p. 132725008  
p. 141

CROMATO

01-4801/A

ALTRE FINITURE

XX-4801/A

x M\*



CARTUCCIA

CARTUCCIA  
TERMOSTATICAVITONE  
CERAMICO

DEVIATORE

AERATORE  
TONDO





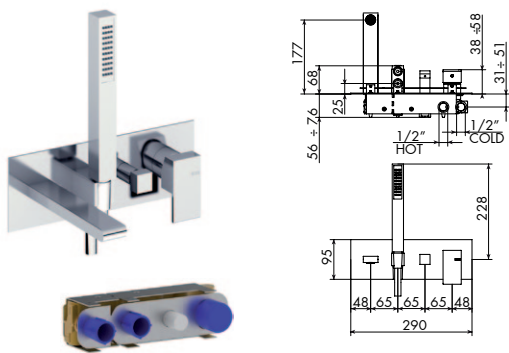

7800/2/P/E + 724028 | JQ



MISCELATORE INCASSO C/DEVIATORE, DOCCINO E BOCCA

- > cartuccia tradizionale
- > interasse bocca 180
- > deviatore a pressione 2 uscite c/ritorno automatico e blocco meccanico basse pressioni
- > attacchi da 1/2" > flessibile PVC 150 cm
- > doccetta monogetto cilindrica in ABS c/anticalcare, per finiture diverse da cromo doccetta in metallo

	025002
	p. 149
	724030
	p. 132
	785015
	p. 142

PARTI ESTERNE - CROMATO

01-7800/2/P/E

PARTE INCASSO

01-724028 info pag. 39

PREZZO TOTALE

PARTI ESTERNE - ALTRE FINITURE

XX-7800/2/P/E

x M\*

4801/4/A/E + 734012 | JEANS

NEW

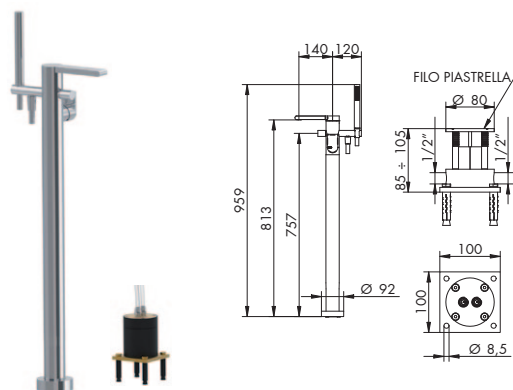

MISCELATORE VASCA C/ATTACCO A PAVIMENTO

- > cartuccia tradizionale
- > interasse bocca 140
- > bocca girevole 360°
- > deviatore a trazione con ritorno automatico
- > flessibile in PVC 150 cm > gancio incorporato
- > attacchi 1/2" > senza scarico
- > doccetta monogetto cilindrica in ABS c/anticalcare, per finiture diverse da cromo doccetta in metallo

	025002
	p. 149
	725008
	p. 141

PARTI ESTERNE - CROMATO

01-4801/4/A/E

PARTE INCASSO

734012 info pag. 34

PREZZO TOTALE

PARTI ESTERNE - ALTRE FINITURE

XX-4801/4/A/E

x M\*

7801/4/A/E + 734012 | JQ

NEW

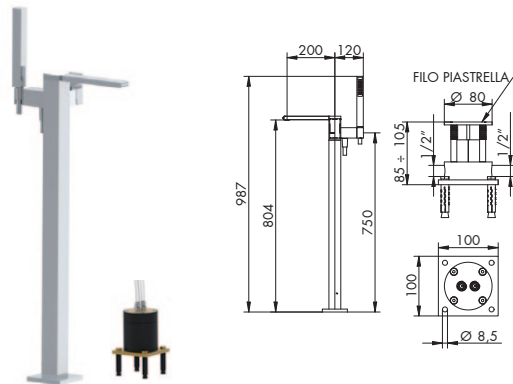

MISCELATORE VASCA C/ATTACCO A PAVIMENTO

- > cartuccia tradizionale
- > interasse bocca 200
- > deviatore a dischi ceramici 2 uscite
- > flessibile in PVC 150Cm
- > gancio incorporato
- > parte incasso attacchi 1/2" > senza scarico
- > doccetta monogetto cilindrica in ABS c/anticalcare, per finiture diverse da cromo doccetta in metallo

	025002
	p. 149
	755058
	p. 132
	785015
	p. 142

PARTI ESTERNE - CROMATO

01-7801/4/A/E

PARTE INCASSO

734012 info pag. 34

PREZZO TOTALE

PARTI ESTERNE - ALTRE FINITURE

XX-7801/4/A/E

x M\*

4803 | JEANS

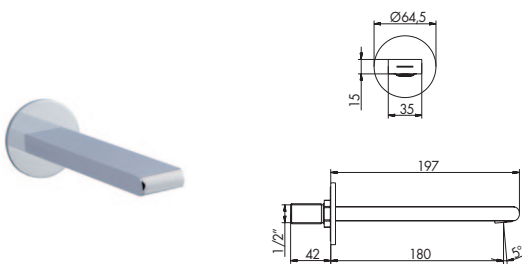

BOCCA VASCA DA PARETE

- > interasse bocca 180
- > attacchi da 1/2"

	725008
	p. 141

CROMATO

01-4803

ALTRE FINITURE

XX-4803

x M\*

4803/Q | JEANS e JQ

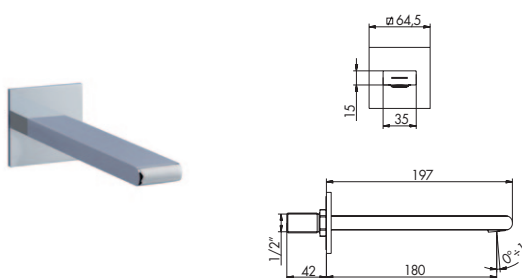

BOCCA VASCA DA PARETE

- > interasse bocca 180
- > aeratore orientabile
- > attacchi da 1/2"
- > rosone quadro

	785015
	p. 142

CROMATO

01-4803/Q

ALTRE FINITURE

XX-4803/Q

x M\*

4808/E + 054025 DX o 054026 SX | JEANS

RUBINETTO INCASSO 1/2"

> vitone ceramico 90°  
> ingressi da 1/2"

 055001  
p. 151

 055002  
p. 151

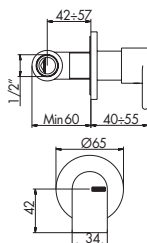

PARTI ESTERNE - CROMATO

01-4808/E

PARTE INCASSO

054025 o 054026 info pag. 40

PREZZO TOTALE

PARTI ESTERNE - ALTRE FINITURE

XX-4808/E

x M\*

4808/Q/E + 054025 DX o 054026 SX | JEANS

RUBINETTO INCASSO 1/2"

> vitone ceramico 90°  
> rosone quadro  
> ingressi da 1/2"

 055001  
p. 151

 055002  
p. 151

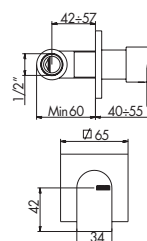

PARTI ESTERNE - CROMATO

01-4808/Q/E

PARTE INCASSO

054025 o 054026 info pag. 40

PREZZO TOTALE

PARTI ESTERNE - ALTRE FINITURE

XX-4808/Q/E

x M\*

7808/E + 054025 DX o 054026 SX | JQ

RUBINETTO INCASSO 1/2"

> vitone ceramico 90°  
> ingressi da 1/2"

 055001  
p. 151

 055002  
p. 151

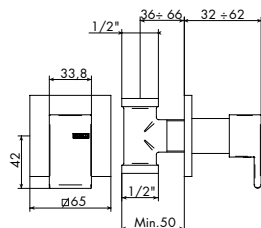

PARTI ESTERNE - CROMATO

01-7808/E

PARTE INCASSO

054025 o 054026 info pag. 40

PREZZO TOTALE

PARTI ESTERNE - ALTRE FINITURE

XX-7808/E

x M\*

4808/E + 054027 DX o 054028 SX | JEANS

RUBINETTO INCASSO 3/4"

> vitone ceramico 90°  
> ingressi da 3/4"

 055001  
p. 151

 055002  
p. 151

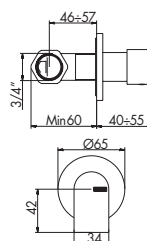

PARTI ESTERNE - CROMATO

01-4808/E

PARTE INCASSO

054027 o 054028 info pag. 40

PREZZO TOTALE

PARTI ESTERNE - ALTRE FINITURE

XX-4808/E

x M\*

4808/Q/E + 054027 DX o 054028 SX | JEANS

RUBINETTO INCASSO 3/4"

> vitone ceramico 90°  
> rosone quadro  
> ingressi da 3/4"

 055001  
p. 151

 055002  
p. 151

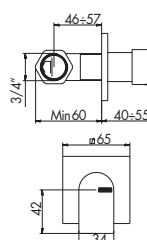

PARTI ESTERNE - CROMATO

01-4808/Q/E

PARTE INCASSO

054027 o 054028 info pag. 40

PREZZO TOTALE

PARTI ESTERNE - ALTRE FINITURE

XX-4808/Q/E

x M\*

7808/E + 054027 DX o 054028 SX | JQ

RUBINETTO INCASSO 3/4"

- > vitone ceramico 90°
- > ingressi da 3/4"

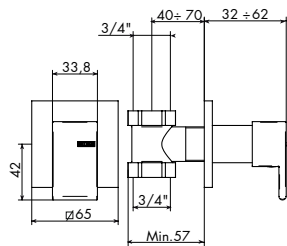
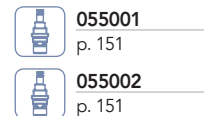

PARTI ESTERNE - CROMATO

01-7808/E

PARTE INCASSO

054027 o 054028 info pag. 40

PREZZO TOTALE

PARTI ESTERNE - ALTRE FINITURE

XX-7808/E

x M\*

4840/E + 654099 | JEANS

PASSO RAPIDO 3/4"

- > vitone tradizionale
- > abbinare a saracinesca
- > ingressi da 3/4"

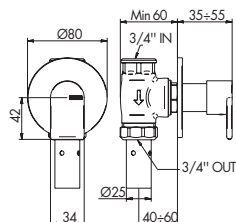
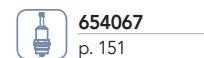

PARTI ESTERNE - CROMATO

01-4840/E

PARTE INCASSO

654099 info pag. 42

PREZZO TOTALE

PARTI ESTERNE - ALTRE FINITURE

XX-4840/E

x M\*

4840/Q/E + 654099 | JEANS

PASSO RAPIDO 3/4"

- > vitone tradizionale
- > abbinare a saracinesca
- > rosone quadro
- > ingressi da 3/4"

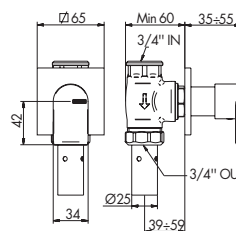
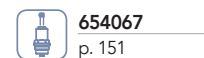

PARTI ESTERNE - CROMATO

01-4840/Q/E

PARTE INCASSO

654099 info pag. 42

PREZZO TOTALE

PARTI ESTERNE - ALTRE FINITURE

XX-4840/Q/E

x M\*

7840/E + 654099 | JQ

PASSO RAPIDO 3/4"

- > vitone tradizionale
- > abbinare a saracinesca
- > ingressi da 3/4"

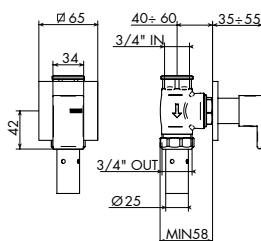
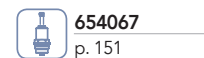

PARTI ESTERNE - CROMATO

01-7840/E

PARTE INCASSO

654099 info pag. 42

PREZZO TOTALE

PARTI ESTERNE - ALTRE FINITURE

XX-7840/E

x M\*

4840/E + 654100 | JEANS

PASSO RAPIDO 1"

- > vitone tradizionale
- > abbinare a saracinesca
- > ingressi da 1"

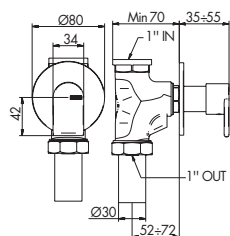
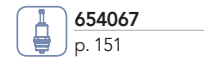

PARTI ESTERNE - CROMATO

01-4840/E

PARTE INCASSO

654100 info pag. 42

PREZZO TOTALE

PARTI ESTERNE - ALTRE FINITURE

XX-4840/E

x M\*

4840/Q/E + 654100 | JEANS

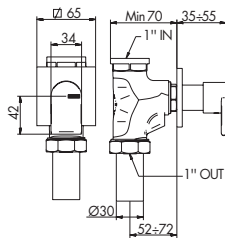

PASSO RAPIDO 1"

- > vitone tradizionale
- > abbinare a saracinesca
- > rosone quadro
- > ingressi da 1"

654067  
p. 151

PARTI ESTERNE - CROMATO

01-4840/Q/E

PARTE INCASSO

654100 info pag. 42

PREZZO TOTALE

PARTI ESTERNE - ALTRE FINITURE

XX-4840/Q/E

x M\*

7840/E + 654100 | JQ

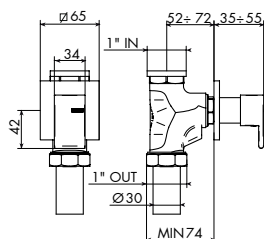

PASSO RAPIDO 1"

- > vitone tradizionale
- > abbinare a saracinesca
- > ingressi da 1"

654067  
p. 151

PARTI ESTERNE - CROMATO

01-7840/E

PARTE INCASSO

654100 info pag. 42

PREZZO TOTALE

PARTI ESTERNE - ALTRE FINITURE

XX-7840/E

x M\*

4832/2/E + 035212 | JEANS

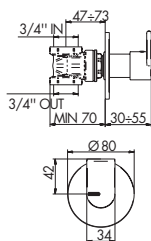

SARACINESCA

- > attacchi da 3/4"

PARTI ESTERNE - CROMATO

01-4832/2/E

PARTE INCASSO

035212 info pag. 42

PREZZO TOTALE

PARTI ESTERNE - ALTRE FINITURE

XX-4832/2/E

x M\*

4832/2/Q/E + 035212 | JEANS

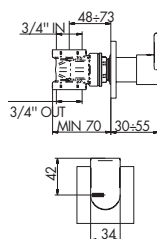

SARACINESCA

- > attacchi da 3/4"
- > rosone quadro

PARTI ESTERNE - CROMATO

01-4832/2/Q/E

PARTE INCASSO

035212 info pag. 42

PREZZO TOTALE

PARTI ESTERNE - ALTRE FINITURE

XX-4832/2/Q/E

x M\*

7832/2/E + 035212 | JQ

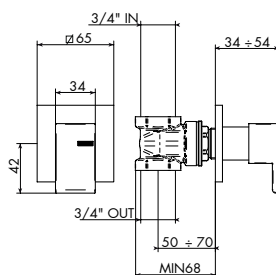

SARACINESCA

- > attacchi da 3/4"

PARTI ESTERNE - CROMATO

01-7832/2/E

PARTE INCASSO

035212 info pag. 42

PREZZO TOTALE

PARTI ESTERNE - ALTRE FINITURE

XX-7832/2/E

x M\*