

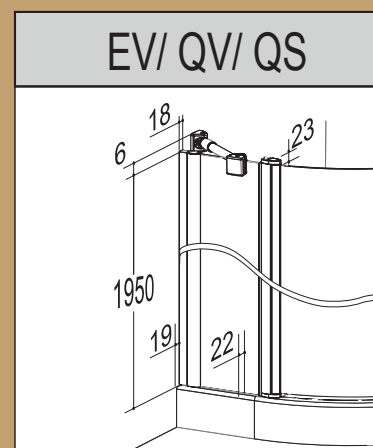

TRANSPARENT DESIGN  
WITH SOPHISTICATED  
TECHNICAL SOLUTIONS

INDICE VARIO  
 INHALT VARIO  
 INDEX VARIO  
 INDICE VARIO

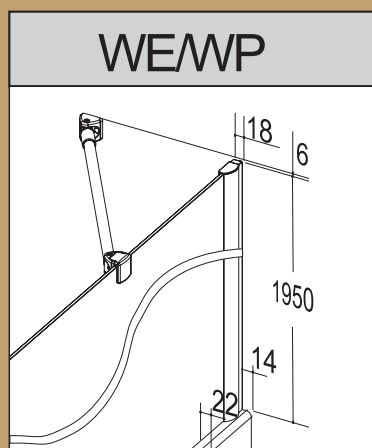

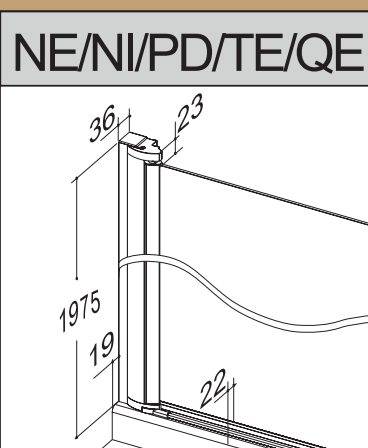
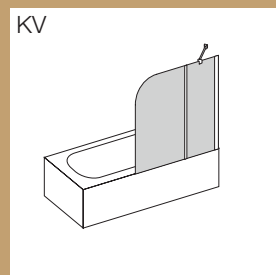
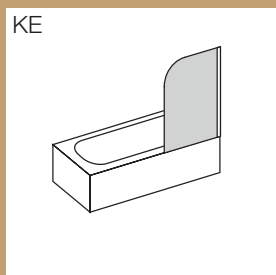
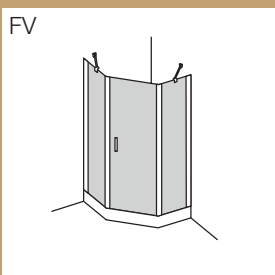
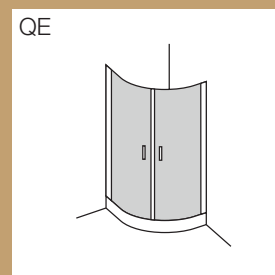
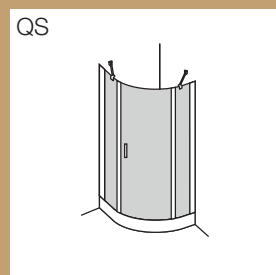
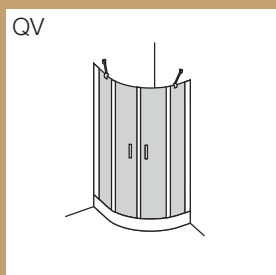
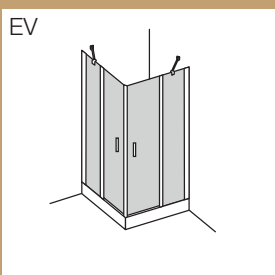
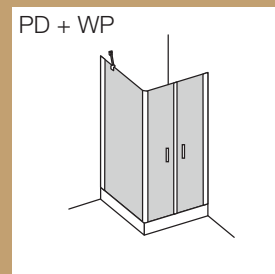
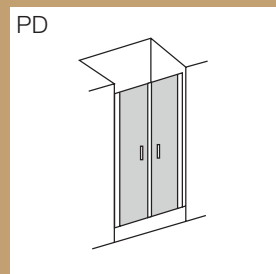
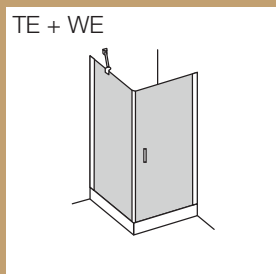
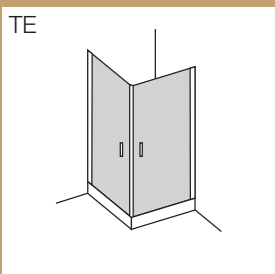
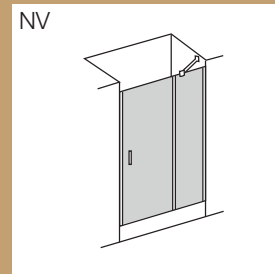
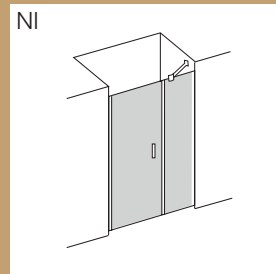
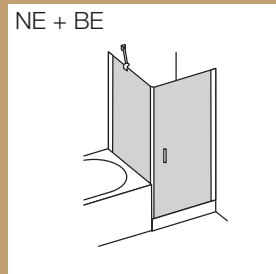
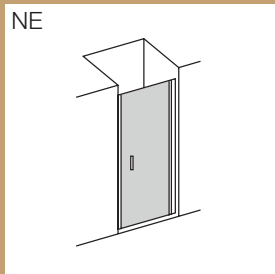

## BOX CON PARZIALE TELAIO

- Design trasparente senza profili orizzontali
- Porte con meccanismo di sollevamento/abbassamento
- I box doccia hanno un'estensibilità da 25 – 35 mm
- Tenuta stagna testata a 11 litri/minuto
- Altezza 1975 mm (altezza vetro 1950 mm)
- Massima entrata usando porte pivotanti
- Regolazione fine e aggiustamento delle porte
- Profilo a parete senza bisogno di silicone



## TEILRAHMENKABINEN

- Transparentes Design ohne Querverbinder
- Türelemente mit Hebe- Senkmechanismus
- Die Kabinen haben einen Verstellbereich von 25 – 35 mm
- Getestete Wasserdichtheit von 11 Liter/Minute
- Kabinenhöhe 1975 mm (Glashöhe 1950 mm)
- Maximale Einstiegsbreite durch die großen Schwingtüren
- Feineinstellung und Nachadjustierung der Türelemente
- Silikonfreier Wandanschluss

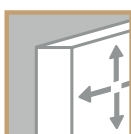

## PARTIAL FRAMED SHOWER ENCLOSURE

- Transparent design without horizontal profiles
- Door elements with up and down lifting mechanism
- The shower enclosures adjust from 25 - 35 mm
- Tested to be watertight 11 litres per minute
- Enclosures height of 1975 mm (glass height 1950 mm)
- Maximum entrance through the large swinging doors
- Micro- and re-adjustment of the door elements
- Silicone free wall junction



## CABINA CON PERFIL PARCIAL

- Diseño transparente sin perfil horizontal
- Puertas con mecanismo de levantamiento/descenso
- La cabina de ducha tiene una extensibilidad de 25 – 35 mm
- No sale el agua al exterior de 11 litros/minutos
- Altura 1975 mm (altura vidrio 1950 mm)
- Gran abertura con puertas pivotantes
- Regulación extrema en el ajustamiento de las puertas
- Fijación a pared sin necesidad de silicona

# VARIO NE + BE

ENTRATA FRONTALE + LATERALE PER VASCA  
FRONTEINSTIEG + SEITENWAND FÜR BADEWANNE  
FRONT ENTRY + SIDE PANEL FOR BATHTUB  
ENTRADA FRONTAL + PARED PARA BAÑERA





High  
GLASS



NE 1975 BE max 1800

OH High Glass GH High Glass SC OG GL 6 mm

28 30 05

Descrizione Articolo Artikelbezeichnung Model description Descripción artículo	Articolo Artikel Model Código	Misura piatto doccia Tassenmaß Tray size Medidas del plato mm	Estensibilità Verstellbarkeit Adjustability Extensibilidad mm	Misura Maß Size Medidas mm A B
<p><b>Porta basculante</b> Pendeltür Saloon door Puerta basculante</p>	1001 NE	700	668 - 703	580 595
	1002 NE	750	718 - 753	630 655
	1003 NE	800	768 - 803	680 695
	1004 NE	900	868 - 903	780 795
	1005 NE	1000	968 - 1003	880 895
<p><b>Laterale per vasca</b> Seitenteil für Badewanne Side panel for bathtub Pared lateral para bañera</p>	0015 BE**	700 - 1000	25	

\*\* Articolo é sempre un fuori misura / Artikel ist immer Sondermaß / article is always special measure / artículo es siempre medida especial

**Indicare sempre bordo piatto fino bordo vasca/muretto**  
 Oberkante Duschtasse bis Badewanne/Mauer immer angeben  
 Indicate always shower tray to bathtub panel/wall  
 Indique siempre borde superior plato de ducha y bañera/muro

# VARIO NI

PORTA CON FISSO IN LINEA  
TÜR MIT FESTFELD IN LINIE  
PIVOT DOOR WITH IN-LINE FIXED PANEL  
PUERTA CON LATERAL FIJO





Descrizione Articolo Artikelbezeichnung Model description Descripción artículo	Articolo Artikel Model Código	Misura piatto doccia Tassenmaß Tray size Medidas del plato mm	Estensibilità Verstellbarkeit Adjustability Extensibilidad mm		Misura Maß Size Medidas mm			
<p><b>Porta basculante in linea</b> Pendeltür mit Festfeld in Linie Saloon door with in-line fixed panel Puerta basculante con lateral fijo</p>	1005 NI	1000	955 - 1005		330	580	595	
	1006 NI	1100	1055 - 1105		330	680	695	
	1007 NI	1200	1155 - 1205		330	780	795	
	1009 NI	1400	1355 - 1405		530	780	795	



# VARIO NV

PORTA CON FISSO IN LINEA

TÜR MIT FESTFELD IN LINIE

PIVOT DOOR WITH IN-LINE FIXED PANEL

PUERTA CON LATERAL FIJO







Descrizione Articolo Artikelbezeichnung Model description Descripción artículo	Articolo Artikel Model Código	Misura piatto doccia Tassenmaß Tray size Medidas del plato mm	Estensibilità Verstellbarkeit Adjustability Extensibilidad mm	Misura Maß Size Medidas mm		
				A	B	
 <p><b>Porta basculante in linea</b> Pendeltür mit Festfeld in Linie Saloon door with in-line fixed panel Puerta basculante con lateral fijo</p>	1005 NV	1000	968 - 1003	665	310	
	1006 NV	1100	1068 - 1103	665	410	
	1007 NV	1200	1168 - 1203	665	510	
	1009 NV	1400	1368 - 1403	665	710	
 <p><b>Laterale per vasca</b> Seitenteil für Badewanne Side panel for bathtub Pared lateral para bañera</p>	0015 BE**	700 - 1000	25			

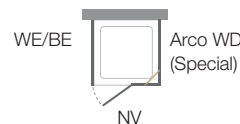

# VARIO TE

BOX AD ANGOLO  
ECKEINSTIEG  
CORNER ENTRY  
CABINA ANGULAR





OH High Glass	GH High Glass	SC	OG	GL	6 mm
------------------	------------------	----	----	----	------

28	30	05	
----	----	----	--

Descrizione Articolo Artikelbezeichnung Model description Descripción artículo	Articolo Artikel Model Código	Misura piatto doccia Tassenmaß Tray size Medidas del plato mm	Estensibilità Verstellbarkeit Adjustability Extensibilidad mm	Misura centro vetro Mitte Glasmaß Glass size middle Medida vidrio centro mm	Misura Maß Size Medidas mm A
<p><b>Box ad angolo*</b> EckEinstieg* Corner entry* Cabina angular*</p>	0001 TE	700	665 - 690	650 - 675	800
	0002 TE	750	715 - 740	700 - 725	870
	0003 TE	800	765 - 790	750 - 775	940
	0004 TE	900	865 - 890	850 - 875	1080
	0005 TE	1000	965 - 990	950 - 975	1180

\*Usate 2 articoli TE per il box completo / Verwenden Sie 2 x Artikel TE für die komplette Kabine / Use 2 article TE for the complete box / Le rogamos de usar 2 x TE per para la cabina completa

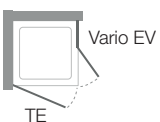

# VARIO **TE + WE**

PORTA PIVOT CON LATERALE  
SCHWINGTÜR MIT SEITENTEIL  
PIVOT DOOR WITH SIDE PANEL  
PUERTA PIVOTANTE CON LATERAL





High  
GLASS



TE 1975 WE 1950

OH High Glass GH High Glass SC OG GL 6mm

28 30 05

Descrizione Articolo Artikelbezeichnung Model description Descripción artículo	Articolo Artikel Model Código	Misura piatto doccia Tassenmaß Tray size Medidas del plato mm	Estensibilità Verstellbarkeit Adjustability Extensibilidad mm	Misura centro vetro Mitte Glasmaß Glass size middle Medida vidrio centro mm	Misura Maß Size Medidas mm A B
<p><b>Porta basculante</b> Pendeltür Saloon door Puerta basculante</p> <p><b>IN OUT</b></p>	1001 TE	700	665 - 690	650 - 675	580 595
	1002 TE	750	715 - 740	700 - 725	630 655
	1003 TE	800	765 - 790	750 - 775	680 695
	1004 TE	900	865 - 890	850 - 875	780 795
	1005 TE	1000	965 - 990	950 - 975	880 895
<p><b>Laterale per porta basculante</b> Seitenteil für Pendeltür Side panel for saloon door Pared lateral para puerta basculante</p>	1001 WE	700	665 - 690	650 - 675	
	1002 WE	750	715 - 740	700 - 725	
	1003 WE	800	765 - 790	750 - 775	
	1004 WE	900	865 - 890	850 - 875	
	1005 WE	1000	965 - 990	950 - 975	
	1007 WE	1200	1165 - 1190	1150 - 1175	

# VARIO PD

PORTA BASCULANTE  
PENDELTÜR  
SALOON DOOR  
PUERTA BASCULANTE





OH High Glass	GH High Glass	SC	OG	GL	6 mm
------------------	------------------	----	----	----	------

28	30	05	
----	----	----	--

Descrizione Articolo Artikelbezeichnung Model description Descripción artículo	Articolo Artikel Model Código	Misura piatto doccia Tassenmaß Tray size Medidas del plato mm	Estensibilità Verstellbarkeit Adjustability Extensibilidad mm	Misura Maß Size Medidas mm A
<p><b>Porta basculante</b> Pendeltür Saloon door Puerta basculante</p>	0001 PD	700	655 - 705	500
	0002 PD	750	705 - 755	550
	0003 PD	800	755 - 805	600
	0004 PD	900	855 - 905	700
	0005 PD	1000	955 - 1005	800
	0007 PD	1200	1155 - 1205	1000

# VARIO PD + WP

PORTA BASCULANTE CON LATERALE  
PENDELTÜR MIT SEITENTEIL  
SALOON DOOR WITH SIDE PANEL  
PUERTA BASCULANTE CON LATERAL







Descrizione Articolo Artikelbezeichnung Model description Descripción artículo	Articolo Artikel Model Código	Misura piatto doccia Tassenmaß Tray size Medidas del plato mm	Estensibilità Verstellbarkeit Adjustability Extensibilidad mm	Misura centro vetro Mitte Glasmaß Glass size middle Medida vidrio centro mm	Misura Maß Size Medidas mm A	
<p><b>Porta basculante</b> Pendeltür Saloon door Puerta basculante</p>	0001 PD	700	675 - 725	660 - 710	500	
	0002 PD	750	725 - 775	710 - 760	550	
	0003 PD	800	775 - 825	760 - 810	600	
	0004 PD	900	875 - 925	860 - 910	700	
	0005 PD	1000	975 - 1025	960 - 1010	800	
	0007 PD	1200	1175 - 1225	1160 - 1210	1000	
<p><b>Laterale per porta basculante</b> Seitenwand für Pendeltür Side panel for saloon door Lateral para puerta basculante</p>	0001 WP	700	675 - 700	660 - 685		
	0002 WP	750	725 - 750	710 - 735		
	0003 WP	800	775 - 800	760 - 785		
	0004 WP	900	875 - 900	860 - 885		
	0005 WP	1000	975 - 1000	960 - 985		



# VARIO EV

BOX AD ANGOLO  
ECKKABINE  
CORNER ENTRY  
CABINA ANGULAR





Descrizione Articolo Artikelbezeichnung Model description Descripción artículo	Articolo Artikel Model Código	Misura piatto doccia Tassenmaß Tray size Medidas del plato mm	Estensibilità Verstellbarkeit Adjustability Extensibilidad mm	Misura centro vetro Mitte Glasmaß Glass size middle Medida vidrio centro mm	Misura Maß Size Medidas mm		
					A	B	C
 <b>Box ad angolo*</b> Eckkabine* Corner entry* Cabina angular*	0001 EV	700	665 - 690	650 - 675	505	380	310
	0002 EV	750	715 - 740	700 - 725	575	430	310
	0003 EV	800	765 - 790	750 - 775	645	480	310
	0004 EV	900	865 - 890	850 - 875	785	580	310
	0005 EV	1000	965 - 990	950 - 975	925	680	310
	0006 EV	1100	1065 - 1090	1050 - 1075	925	680	410
	0007 EV	1200	1165 - 1190	1150 - 1175	925	680	510

\*Usate 2 articoli EV per il box completo / Verwenden Sie 2 x Artikel EV für die komplette Kabine / Use 2 article EV for the complete box / Le rogamos de usar 2 x EV per para la cabina completa

 <b>Laterale con sostegno</b> Seitenwand mit Stütze Side panel with support Pared lateral con soporte	0001 WE	700	665 - 690	650 - 675			
	0002 WE	750	715 - 740	700 - 725			
	0003 WE	800	765 - 790	750 - 775			
	0004 WE	900	865 - 890	850 - 875			
	0005 WE	1000	965 - 990	950 - 975			
	0007 WE	1200	1165 - 1190	1150 - 1175			

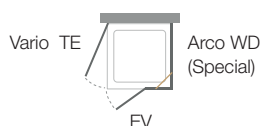
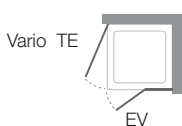

# VARIO QV

BOX ROTONDO  
RUNDKABINE  
SHOWER ENCLOSURE CUBICLE  
CABINA SEMICIRCULAR





Descrizione Articolo Artikelbezeichnung Model description Descripción artículo	Articolo Artikel Model Código	Misura piatto doccia Tassenmaß Tray size Medidas del plato mm	Estensibilità Verstellbarkeit Adjustability Extensibilidad mm	Misura piatto installato Tasseneinbaumaß Tray installation measure Medidas del plato instalado mm	Misura Maß Size Medidas mm		
					A	B	C
 <p><b>Box rotondo*</b> Rundkabine* Shower enclosure cubicle* Cabina semicircular*</p>	6003 QV	800 <b>R 550</b>	765 - 790	775 - 800	615	270	350
	6004 QV	900 <b>R 550</b>	865 - 890	875 - 900	615	370	350
	6005 QV	1000 <b>R 550</b>	965 - 990	975 - 1000	615	470	350
	4003 QV	800 <b>R 500</b>	765 - 790	775 - 800	615	270	350
	4004 QV	900 <b>R 500</b>	865 - 890	875 - 900	615	370	350
	4005 QV	1000 <b>R 500</b>	965 - 990	975 - 1000	615	470	350

\*Usate 2 articoli QV per il box completo / Verwenden Sie 2 x Artikel QV für die komplette Kabine / Use 2 article QV for the complete box / Le rogamos de usar 2 x QV per para la cabina completa

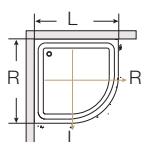

**misura vetro**  
Glasmaß  
glass size  
**- 15 mm**  
see page 20

**Per un montaggio a pavimento**  
l'estensibilità sopra indicata si riduce di  
Bei bodenbündiger Montage reduziert sich  
der oben angeführte Verstellbereich um  
For an installation on the floor adjustability  
mentioned above shifts by e.g. 750-775 mm ←

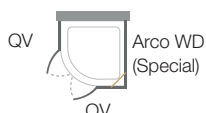

# VARIO QS

BOX ROTONDO CON PORTA PIVOT

RUNDKABINE MIT SCHWENKTÜR

SHOWER ENCLOSURE CUBICLE WITH PIVOT DOOR

CABINA SEMICIRCULAR CON PUERTA PIVOTANTE





Descrizione Articolo Artikelbezeichnung Model description Descripción artículo	Articolo Artikel Model Código	Misura piatto doccia Tassenmaß Tray size Medidas del plato mm	Misura piatto installato Tasseneinbaumaß Tray installation measure Medidas del plato instalado mm		Misura Maß Size Medidas mm		
			A	B	C	D	
<p><b>Laterali box rotondo</b> Seitenwände für Rundkabine Side panels for shower cubicle Laterales para cabina semicircular</p>	6003 QS-S	800 x 800 <b>R 550</b>	775 - 800	775 - 800	635	273	
	6004 QS-S	900 x 900 <b>R 550</b>	875 - 900	875 - 900	635	373	
	6005 QS-S	1000 x 1000 <b>R 550</b>	975 - 1000	975 - 1000	635	473	
	2104 QS-S	700 x 900 <b>R 380</b>	675 - 700	875 - 900	450	308 / 508	
	2401 QS-S	900 x 700 <b>R 380</b>	875 - 900	675 - 700	450	508 / 308	
	2305 QS-S	800 x 1000 <b>R 380</b>	775 - 800	975 - 1000	450	408 / 608	
	2503 QS-S	1000 x 800 <b>R 380</b>	975 - 1000	775 - 800	450	608 / 408	
<p><b>Porta pivot per box rotondo</b> Schwenktür für Rundkabine Swinging door for shower cubicle Puerta abatible cabina semicircular</p>	2099 QS-T	700 / 800 / 900 / 1000 <b>R 380</b>					487
	6099 QS-T	800 / 900 / 1000 <b>R 550</b>					680

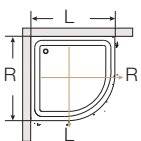

	2401 QS-S 2503 QS-S
	2104 QS-S 2305 QS-S

**misura vetro**  
Glasmaß  
glass size  
**- 15 mm**  
see page 20

Per un montaggio a pavimento l'estensibilità sopra indicata si riduce di  
Bei bodenbündiger Montage reduziert sich der oben angeführte Verstellbereich um  
For an installation on the floor adjustability mentioned above shifts by e.g. 750-775 mm ←



# VARIO QE

BOX ROTONDO

RUNDKABINE

SHOWER ENCLOSURE CUBICLE

CABINA SEMICIRCULAR







High  
GLASS



QE  
1910  
1975

OH	GH	SC	OG	GL	6 mm
High Glass	High Glass	1910	1910	1975	

28	30	05	
----	----	----	--

Descrizione Articolo Artikelbezeichnung Model description Descripción artículo	Articolo Artikel Model Código	Misura piatto doccia Tassenmaß Tray size Medidas del plato mm	Estensibilità Verstellbarkeit Adjustability Extensibilidad mm	Misura piatto installato Tasseneinbaumaß Tray installation measure Medidas del plato instalado mm	Misura Maß Size Medidas mm			
					A	B		
 <b>Box rotondo*</b> Rundkabine* Shower enclosure cubicle* Cabina semicircular*	6003 QE	800 R 550	765 - 790	775 - 800	970	565		
	6004 QE	900 R 550	865 - 890	875 - 900	1110	665		

\*Usate 2 articoli QE per il box completo / Verwenden Sie 2 x Artikel QE für die komplette Kabine / Use 2 article QE for the complete box / Le rogamos de usar 2 x QE per para la cabina completa

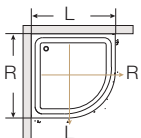

**misura vetro**  
**Glasmaß**  
**glass size**  
**- 15 mm**  
 see page 20

**Per un montaggio a pavimento**  
**l'estensibilità sopra indicata si riduce di**  
 Bei bodenbündiger Montage reduziert sich  
 der oben angeführte Verstellbereich um  
**For an installation on the floor adjustability**  
 mentioned above shifts by e.g. 750-775 mm ←

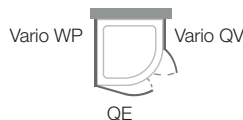
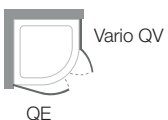

# VARIO FV

BOX PENTAGONALE CON PORTA PIVOT  
FÜNFECKDUSCHE MIT SCHWENKTÜR  
FIVE CORNERED SHOWER ENCLOSURE WITH PIVOT DOOR  
CABINA PENTAGONAL CON PUERTA PIVOTANTE





OH High Glass	GH High Glass	SC	OG	GL	6 mm
------------------	------------------	----	----	----	------

28	30	05	
----	----	----	--

Descrizione Articolo Artikelbezeichnung Model description Descripción artículo	Articolo Artikel Model Código	Misura piatto doccia Tassenmaß Tray size Medidas del plato mm	Estensibilità Verstellbarkeit Adjustability Extensibilidad mm	Misura Maß Size Medidas mm A	
 <b>Box pentagonale - laterali</b> Fünfeckdusche - Seitenwände Five cornered shower enclosure - side panels Cabina pentagonal - laterales	1004 FV-S	900 x 900 (440-650-440)	865 - 890		
	2004 FV-S	900 x 900 (450-635-450)	865 - 890		
	4004 FV-S	900 x 900 (400-700-400)	865 - 890		
	6005 FV-S	1000 x 1000 (500-700-500)	965 - 990		
	7005 FV-S	1000 x 1000 (540-650-540)	965 - 990		
 <b>Box pentagonale - porta</b> Fünfeckdusche - Tür Five cornered shower enclosure - door Cabina pentagonal - puerta	1004 FV-T	900 x 900 (440-650-440)		550	
	2004 FV-T	900 x 900 (450-635-450)		520	
	4004 FV-T	900 x 900 (400-700-400)		580	
	6005 FV-T	1000 x 1000 (500-700-500)		580	
	7005 FV-T	1000 x 1000 (540-650-540)		550	

**misura vetro**  
**Glasmaß**  
**glass size**  
**- 15 mm**  
 see page 20

**Per un montaggio a pavimento**  
 l'estensibilità sopra indicata si riduce di  
 Bei bodenbündiger Montage reduziert sich  
 der oben angeführte Verstellbereich um  
 For an installation on the floor adjustability  
 mentioned above shifts by e.g. 850-875 mm ←



# VARIO KE

ANTINA PER VASCA

KLAPPWAND

SINGLE PANEL PIVOTING BATHTHSCREEN

HOJA PARA BAÑERA





High  
GLASS



KE 1425	KE 1385	
------------	------------	--

OH High Glass	GH High Glass	SC	OG	GL	6 mm
------------------	------------------	----	----	----	------

28	30	05	
----	----	----	--

Descrizione Articolo Artikelbezeichnung Model description Descripción artículo	Articolo Artikel Model Código	Misura vasca Wannenmaß Bathtub size Medidas de la bañera mm	Estensibilità Verstellbarkeit Adjustability Extensibilidad mm	Misura Maß Size Medidas mm A
<p><b>Antina per vasca</b> Klappwand Single panel pivoting bathscreen Hoja para bañera</p>	0001 KE - L/R	700	700 - 725	min. 675
	0002 KE - L/R	750	750 - 775	min. 725
	0003 KE - L/R	800	800 - 825	min. 775
<p><b>Antina per vasca - fissa*</b> Badewannenaufsatz - fix* Trackless bathscreen* Mampara para bañera - fijo*</p>	0011 KE - L/R		680 - 705	
	0012 KE - L/R		730 - 755	
	0013 KE - L/R		780 - 805	

\*Il lato di montaggio da definire nell'ordine (sinistra L - destra R) / Montageseite bei Bestellung definieren (links L - rechts R)  
Define the assembly side when ordering (left L - right R) / Lado de la asamblea se indican en el pedido (izquierda L - derecha R)



KE - L



KE - R



KE

Vario WP / Arco WD (Special)

# VARIO KV

ANTINA PER VASCA  
KLAPPWAND FÜR BADEWANNE  
PIVOTING BATHTHSCREEN  
HOJA PARA BAÑERA





High  
GLASS



KV  
1425

OH High Glass	GH High Glass	SC	OG	GL 6 mm
------------------	------------------	----	----	------------

28	30	05
----	----	----

Descrizione Articolo Artikelbezeichnung Model description Descripción artículo	Articolo Artikel Model Código	Misura vasca Wannenmaß Bathtub size Medidas de la bañera mm	Estensibilità Verstellbarkeit Adjustability Extensibilidad mm	Misura Maß Size Medidas mm		Misura Maß Size Medidas mm	
				A	B		
<p><b>Antina per vasca a 2 ante*</b> 2-teilige Klappwand* Double pivoting bathscreen* Hoja para bañera 2 elementos*</p>	2001 KV - L/R	700	1075 - 1100	435	650	min. 675	
	2002 KV - L/R	750	1125 - 1150	435	700	min. 725	
	2003 KV - L/R	800	1175 - 1200	435	750	min. 775	

\*Il lato di montaggio da definire nell'ordine (sinistra L - destra R) / Montageseite bei Bestellung definieren (links L - rechts R)  
Define the assembly side when ordering (left L - right R) / Lado de la asamblea se indican en el pedido (izquierda L - derecha R)



KV-L



KV-R



KV

Arco WD (Special)