

M E T A M O R F O S I

by **bizzarridesign**

L'ambizione di poter innovare, un'attenta ricerca materica e la messa a punto di innovativi processi di produzione ci hanno permesso di definire una serie di collezioni di tendenza allineate con i nuovi canoni estetici. Prodotti funzionali, ma anche eleganti e decorativi, che pensiamo possano essere i nuovi protagonisti degli spazi dell'abitare contemporaneo: prodotti realizzati utilizzando nuovi abbinamenti di materiali dove protagonista principale rimane sempre e comunque il vetro in tutte le sue declinazioni.

The ambition to innovate, a careful research of the material and the development of innovative production processes have enabled us to create a range of collections that reflect the new aesthetics standard. Functioning, but also smart and decorative products will be the new protagonists of the contemporary homes.

This products are manufactured thanks to the use of new combinations of materials where the principal protagonist is always glass.



+skin

Programma di mobili contenitori versatili e funzionali caratterizzati dalla possibilità di essere interpretati tramite l'utilizzo di svariate finiture, quali ad esempio, vetri, specchi, grés decorativi e grafiche.

A range of versatile and functioning vanities characterized by the usage of several materials as, for instance, glass, mirror, decorative porcelain and print.





COMPOSITION AL586
 collection +skin
 cabinet covering calypso
 cabinet frame peltro PE
 top and basin opalite nero 24
 mirror ri-tratti collection
 wall covering paper collection fin. calypso

CALYPSO



OPALITE NERO 24



PELTRO PE



+skin



COMPOSITION AL587
collection +skin
cabinet covering laminam filo argento
cabinet frame bronzo BR
top and basin basintop opalite bianco 20
mirror riflessi collection

+skin



+skin

COMPOSITION
collection
cabinet covering
cabinet frame
top and basin
mirror

AL588
+skin
specchio fumé grigio
pelto PE
basintop opalite bianco 20
riflessi collection



COMPOSITION AL589
collection +skin
cabinet covering laminam filo ghisa
cabinet frame peltro PE
top and basin moho finitura garden
mirror mirror collection
lighting basket collection

+skin



LAMINAM FILO GHISA

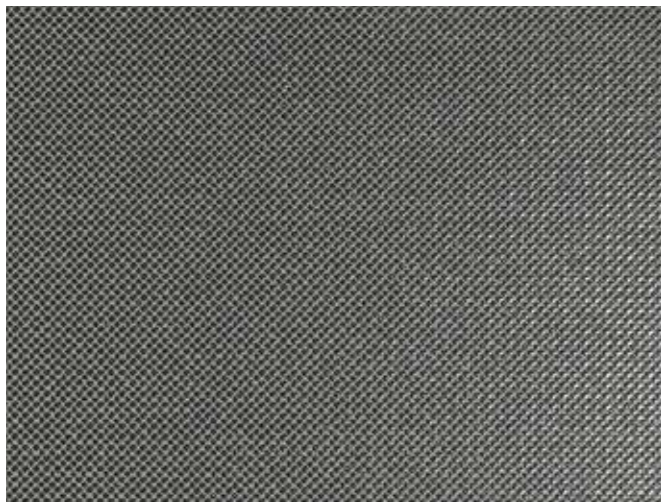

PELTRO PE



GARDEN



plissé

Sintesi tra rigore formale ed eleganza materica, la collezione Plissé dà vita ad una serie di totem lavabo contenitivi realizzati totalmente in vetro con particolari in metallo.

A combination of precise shapes and elegant materials, the Plissé collection is a range of freestanding units entirely manufactured in glass with some metal details.

COMPOSITION **AL590**
collection **plissé**
cabinet covering **flutes bronzo**
cabinet frame **bronzo BR**
basin **cristallo bronzo**
mirror **riflessi collection**
lighting **basket collection**



VETRO TRASPARENTE BRONZATO



FLUTES RETROVERNICIATO BRONZO



BRONZO BR



plissé

COMPOSITION AL591
collection plissé
cabinet covering flutes bianco
cabinet frame bronzo BR
basin cristallo bianco/extrachiario
mirror gemme collection esagonali specchio 02
columns passepartout
column glass trasparente extrachiario
column structure noce canaletto + laccato bianco
lighting basket collection



plissé





COMPOSITION

collection
cabinet covering
cabinet frame
basin
mirror

AL592

plissé
flutes nero
peltro PE
opalite nero/fumé
eclipse collection

eclipse

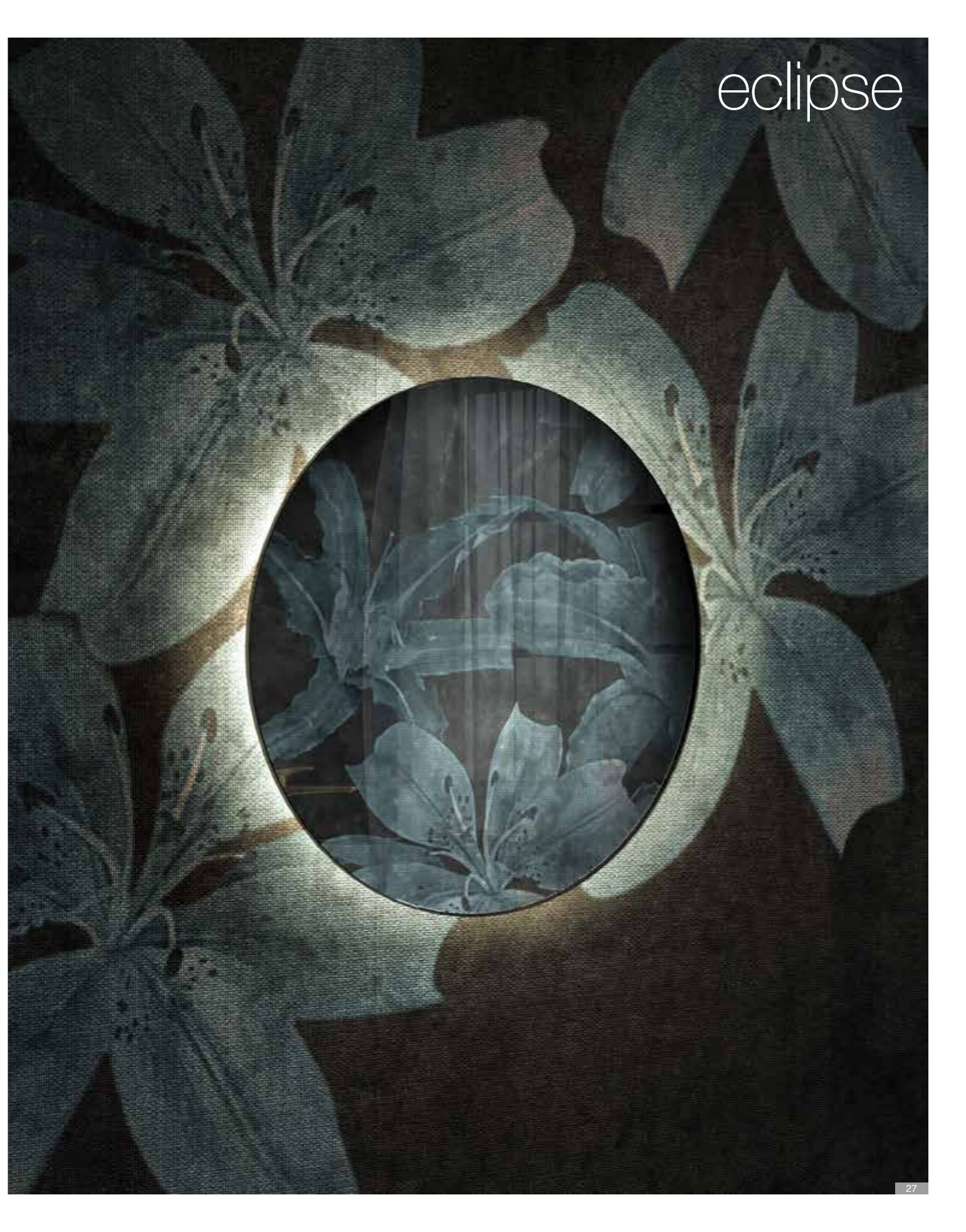



T-60

Abbiamo cavalcato l'attuale orientamento di perseguire forme e linee tendenzialmente Vintage. Ne deriva una composizione lineare e pulita, ma allo stesso tempo funzionale e significativa nella sua semplicità.

La combinazione di materiali come vetro e metallo, apparentemente così essenziali, attribuisce carattere ed espressività alla collezione stessa.

We have followed the current orientation in searching vintage lines and shapes.

As a result, we have obtained a linear and smooth vanity, and at the same time a functioning vanity in its simplicity.

The match of apparently essential materials such as glass and metal gives the collection character and expressiveness.



COMPOSITION **AL593**
collection **T-60 (+skin cabinet)**
cabinet covering **flutes bianco**
cabinet frame **bronzo BR**
top and basin **moho finitura cherry**
wall covering **mirror collection + glass collection finitura cherry**

T-60



T-60

LAMINAM I NATURALI BIANCO STATUARIO



PELTRO PE



OPALITE NERO 24

COMPOSITION
collection
cabinet covering
cabinet frame
top and basin
mirror

AL594
T-60 (+skin cabinet)
laminam i naturali bianco statuario
peltro PE
opalite nero
ri-tratti collection



T-60



T-60

SPECCHIO 02



PELTRO PE

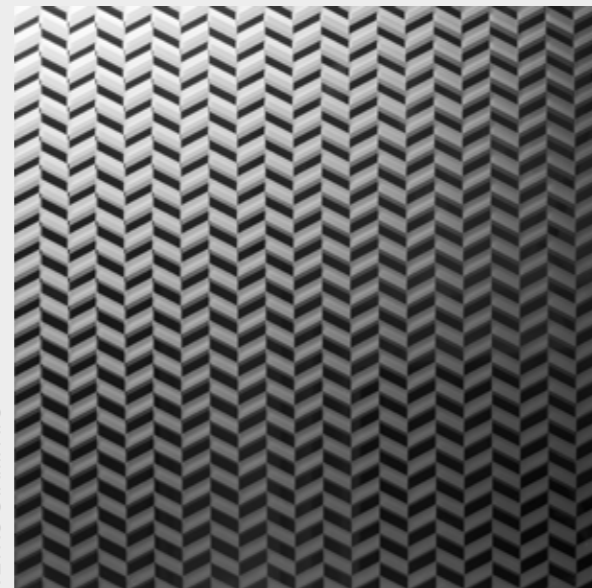

VETRO STAMPATO



COMPOSITION

collection
cabinet covering
cabinet frame
top and basin
mirror

AL595

T-60 (+skin cabinet)
specchio stampato grigio
peltro PE
specchio fumé grigio
riflessi collection

moho

Un innovativo processo produttivo frutto della ricerca dell'azienda dà vita ad un top altamente decorativo declinato in 3 varianti cromatiche per composizioni ad elevato impatto emozionale.

An innovative production process, the outcome of the research of the company, which creates a high decorative top available in 3 different colour finishes for compositions with a high emotional impact.



top moho (PER COLLEZIONI +SKIN E T-60)

CHERRY



CALYPSO



GARDEN



* alzatina cm H25 solo per collezione +skin



passepourtout

Programma di vetrine pensili in varie dimensioni e altezze che nella versione H 210 può essere utilizzata per combinazioni a pavimento di grande capacità contenitiva.

Il mobile è caratterizzato da un'anta in alluminio in finitura brunita (con apertura a 180°) nel quale è possibile montare vetri in extrachiaro, bronzo e fumé sia trasparenti che nella variante satinata. Per la sua rigorosa semplicità estetica Passepourtout si presta per essere utilizzata quale contenitore verticale in abbinamento a tutti i modelli della collezione "Metamorfosi".

A wide range of wall cabinets available in several sizes. In h.210 cm this cabinets can be used as floor storage unit for their big capacity.

This wall cabinets are characterized by the burnished aluminum frame of the door with 180° opening where the glass can be extraclear, bronzo or fumé (both the polished or matt finishes are available). Passepourtout, thanks to its geometric simplicity, is a good match for all the "Metamorfosi" series.



passépartout



columns
columns glass
columns structure

passépartout
trasparente extrachiaro
noce canaletto

ri-tratti

È questa una collezione di specchi luminosi decorativi, di differenti forme e dimensioni, impreziositi da particolari grafiche ottenute attraverso un innovativo processo di lavorazione al laser che ne permette di asportare l'argentatura. Sarà poi attraverso la sagoma di tali disegni che avrà modo di fuoriuscire la luce creando eleganti od iconici scenari luminosi.

This is a collection of decorative mirrors with lighting available in several shapes and sizes. These mirrors show a particular design obtained thanks to an innovative laser engraving process which allows us to remove the silver plating of the mirror. The lighting of the mirror will come out from this laser engravings thus creating elegant or iconic lighting scenarios.



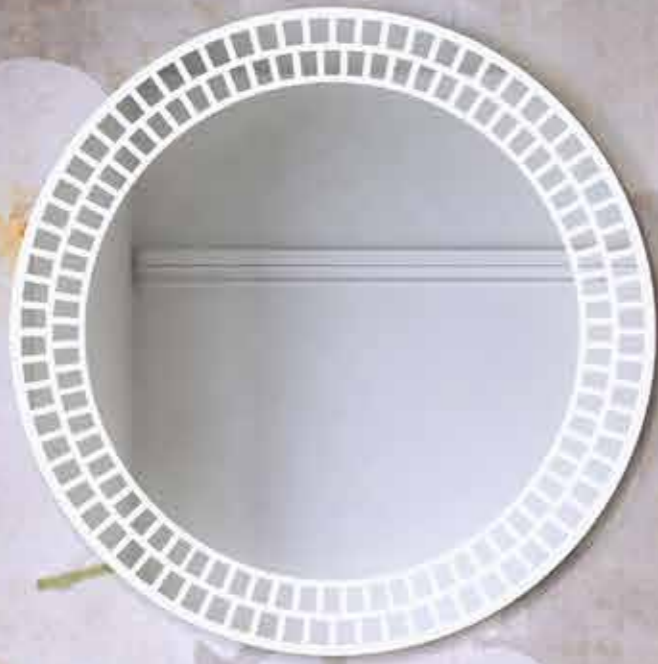

ri-tratti collection

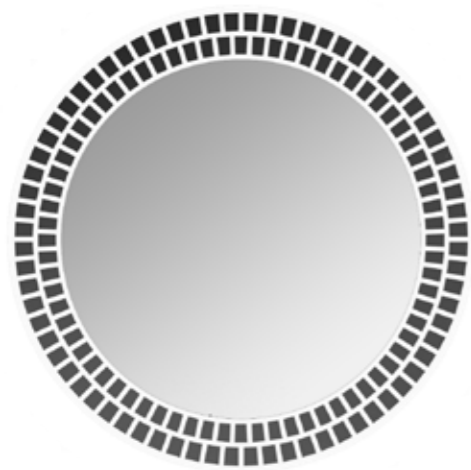

luce diretta

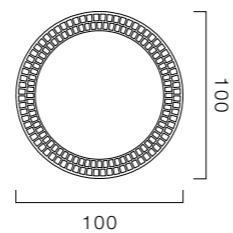
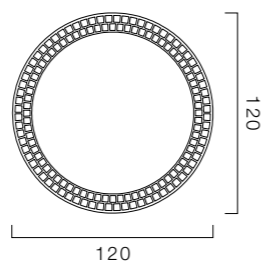

ri-tratti collection



luce diretta e indiretta

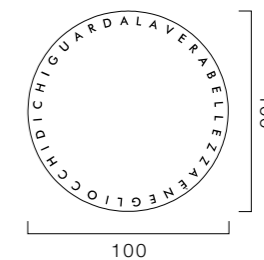

luce diretta

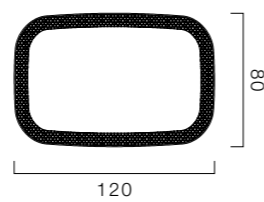
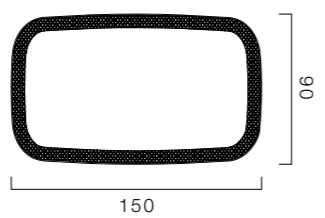
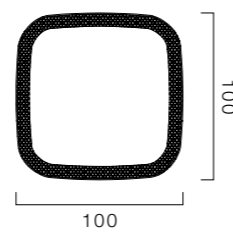
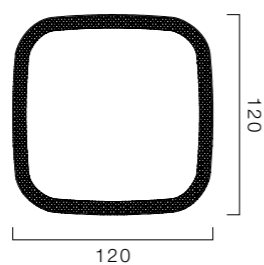

luce diretta e indiretta

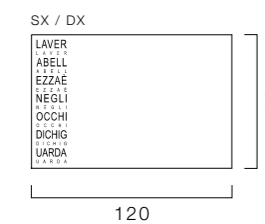
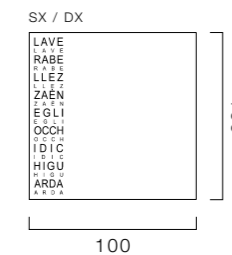

riflessi

Un telaio in metallo nelle finiture bronzo, peltro e bianco opaco attribuisce un importante impatto estetico e decorativo a questa collezione di specchi, specialmente nelle varianti di grandi dimensioni. La possibilità di integrare la luce negli specchi attraverso rigorose campiture geometriche che ne definiscono maggiormente il disegno, rende questi ultimi particolarmente funzionali e adatti a molteplici ambienti sia privati che pubblici.

A metal frame in bronze or peltro finish gives this mirror collection an important aesthetic and decorative impact, especially for the mirrors of big sizes.

The possibility to complete this mirrors with lighting thanks to geometric backgrounds which define the drawing makes these mirrors functioning and suitable for several use both in private and public areas.



riflessi collection

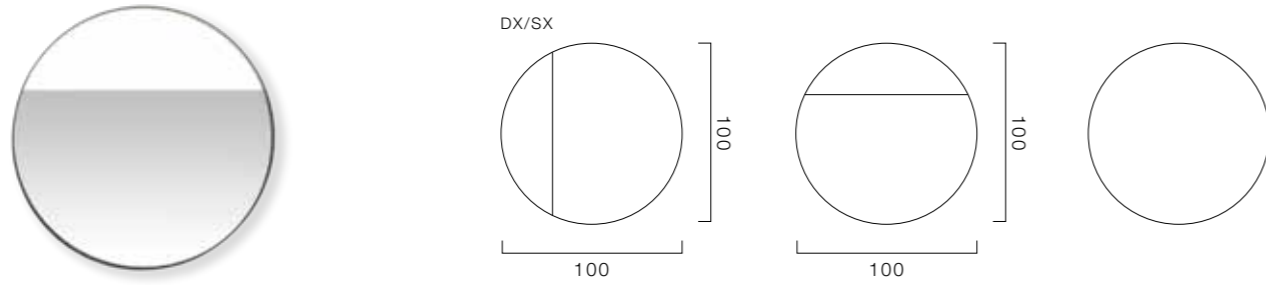

riflessi collection

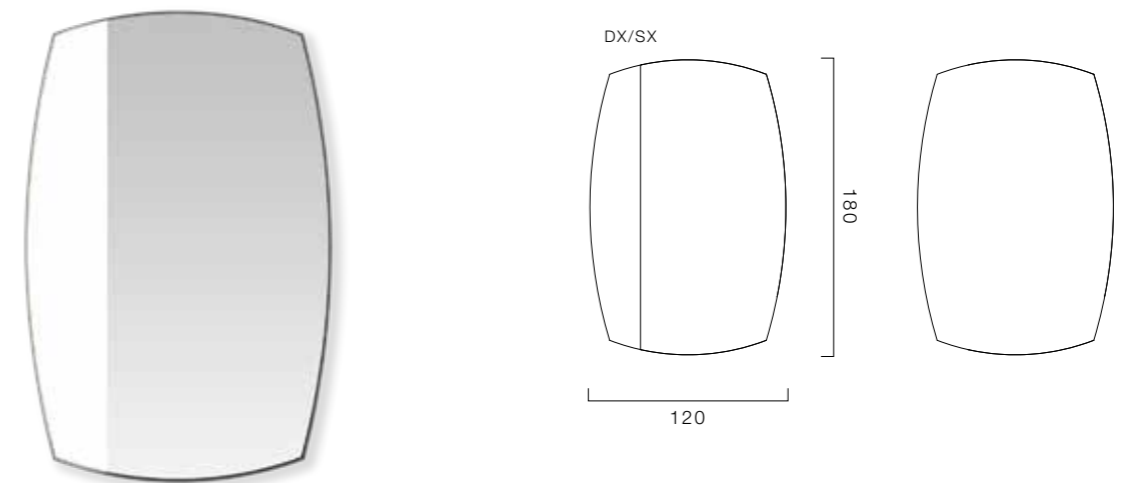
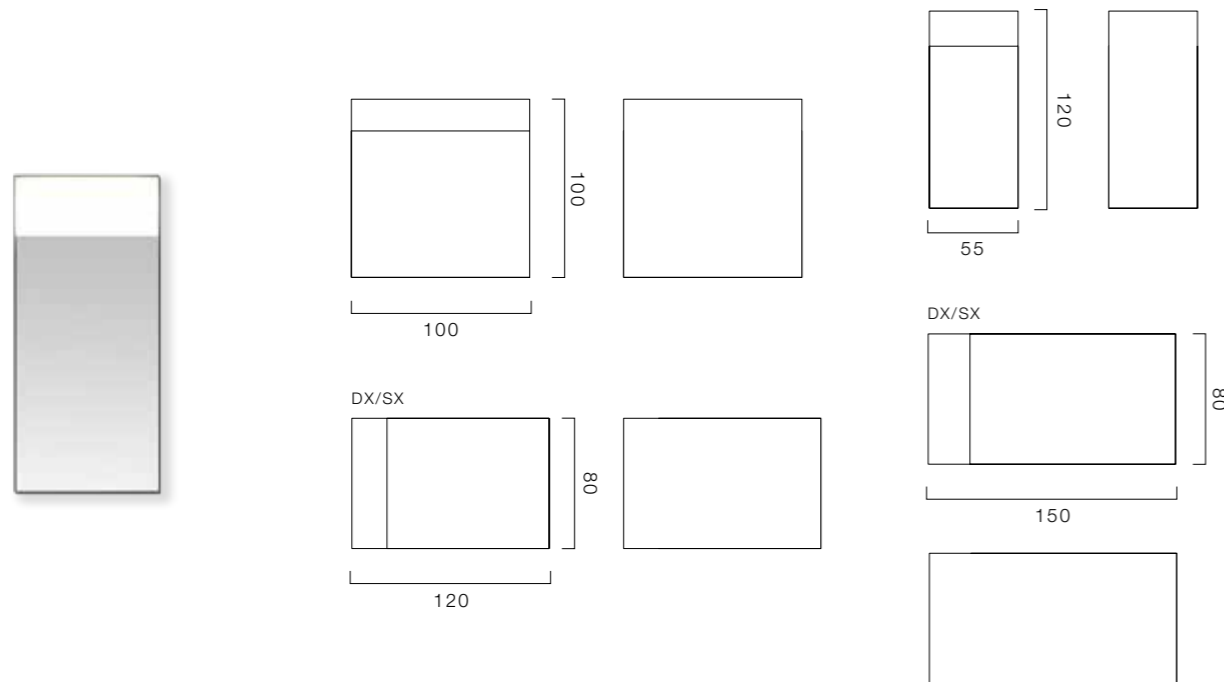
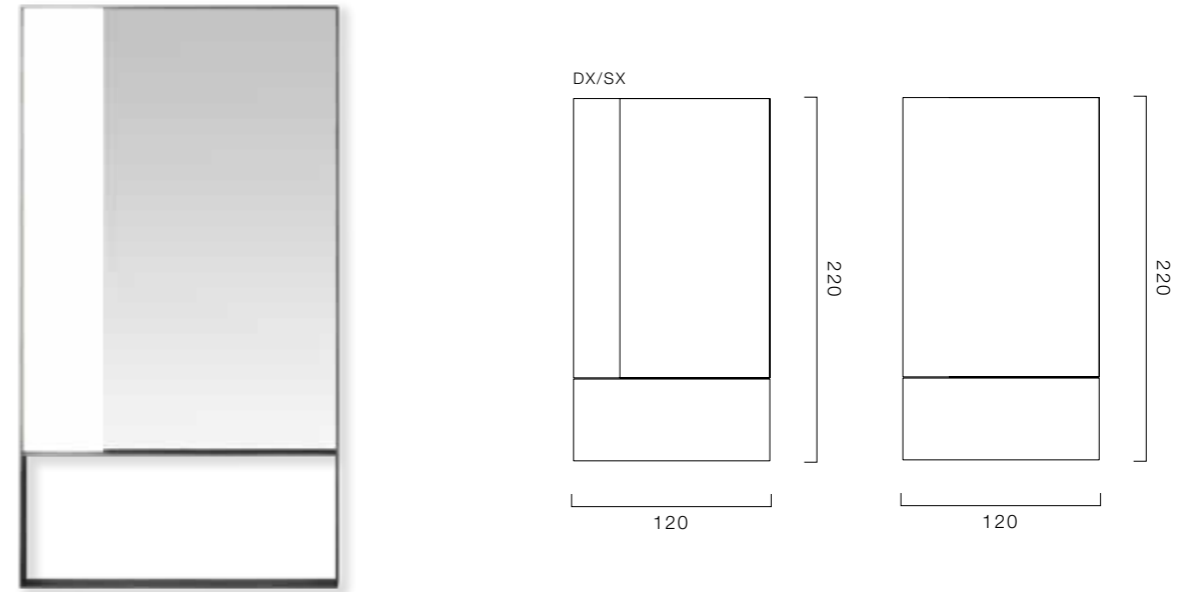

gemme

Una serie di forme geometriche pure contraddistingue questa collezione di specchi predisposti per l'incollaggio a parete.

La possibilità di ottenere composizioni libere o definite ne ampliano la possibilità di utilizzo.

Several geometric shapes characterize this collection of mirrors prepared for being pasted on the wall. The possibility to create both free and prearranged compositions increase the opportunities of their usage.





wall covering
columns
column glass
column structure

**gemme collection losanghe fumé bronzo
passepartout
trasparente extrachiario
noce canaletto**

gemme

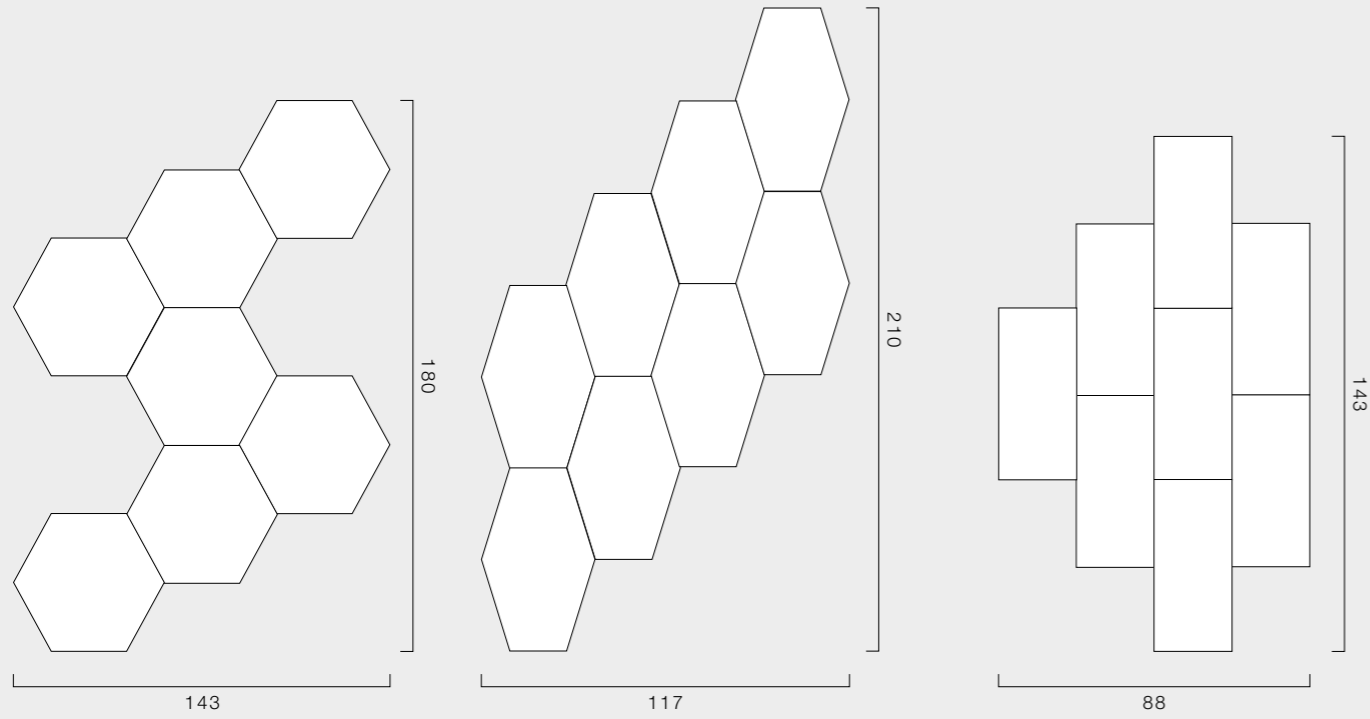

SPECCHIO 02 | SPECCHIO FUMÉ GRIGIO | SPECCHIO FUMÉ BRONZO

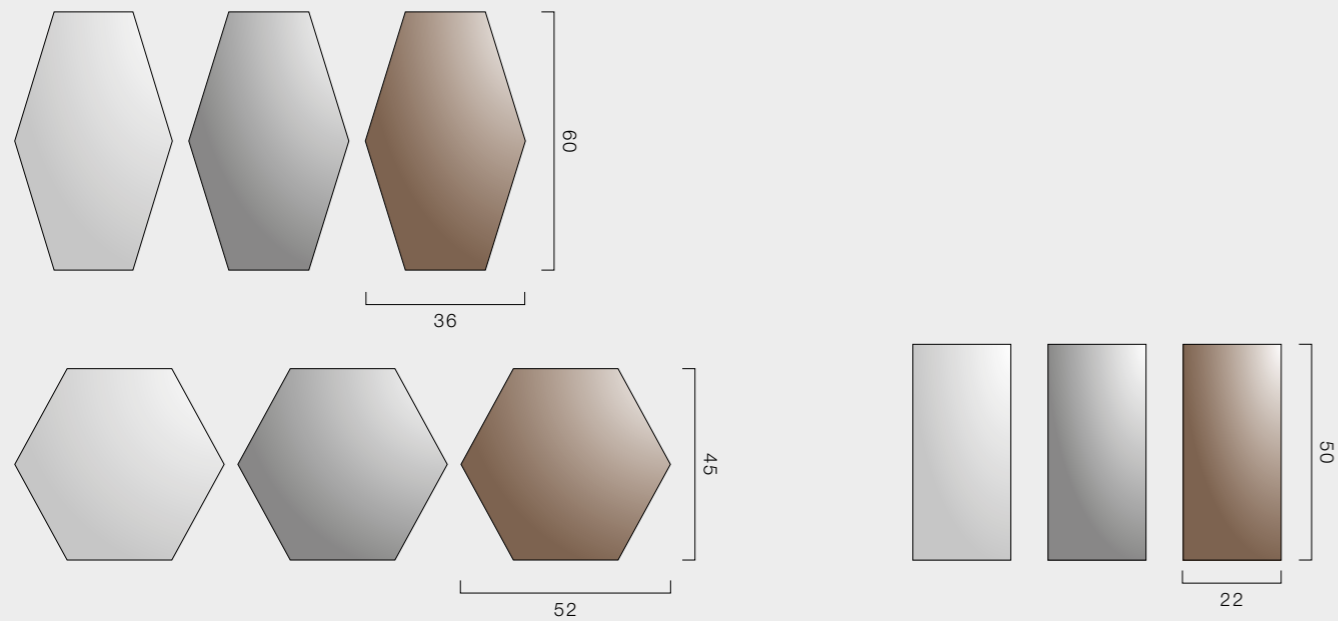

glass & paper collection

Tre differenti rappresentazioni decorative declinate in 2 possibili varianti di rivestimenti murali danno vita a "Glass & Paper Collection". L'idea è quella di poter abbinare la stessa rappresentazione decorativa in un'unica soluzione proposta sia a parete, sia nei top che nelle antine dei mobili.

Three different motifs in two variations of wall coverings create the "Glass & Paper Collection". The idea is to use the same motif for the wall covering, for the tops and for the doors of the cabinets to give continuity to the proposed solution.



glass collection

Ciascuno dei 3 decori è composto nel suo insieme da 9 piastrelle, da comporre liberamente, realizzate in vetro stratificato e Laminam con la possibilità di essere facilmente incollate a parete.

Anyone of the 3 motifs is composed by 9 tiles to be freely arranged. The tiles are manufactured in stratified glass and Laminam and can be easily pasted on the wall.

CHERRY

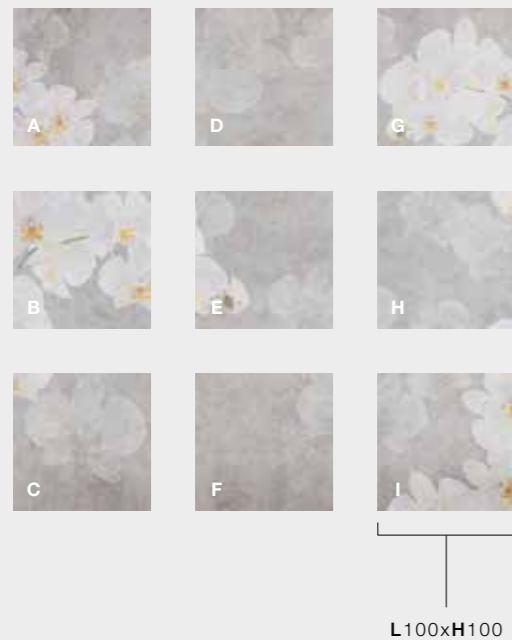

CALYPSO

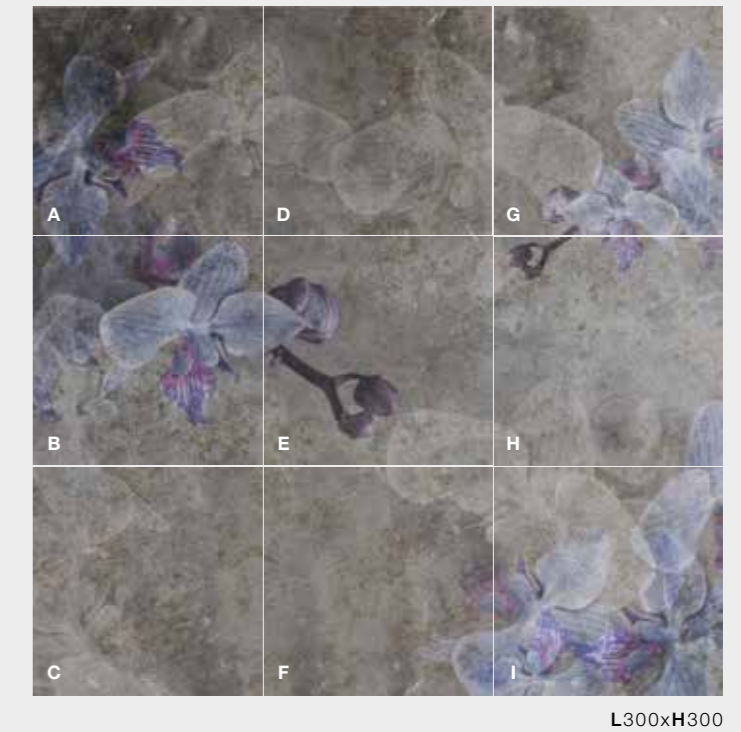
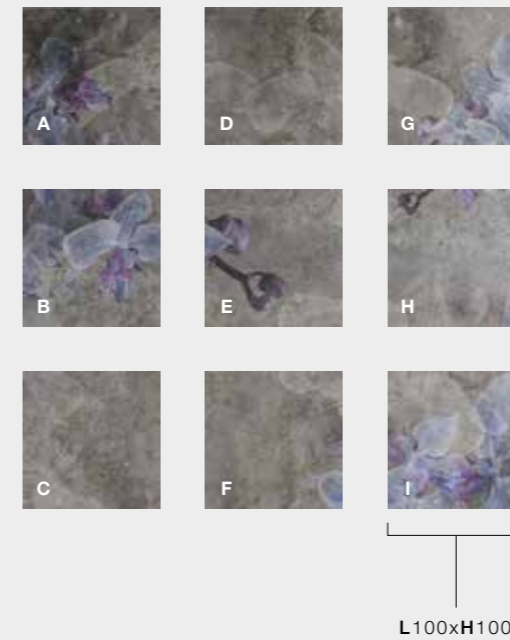

GARDEN

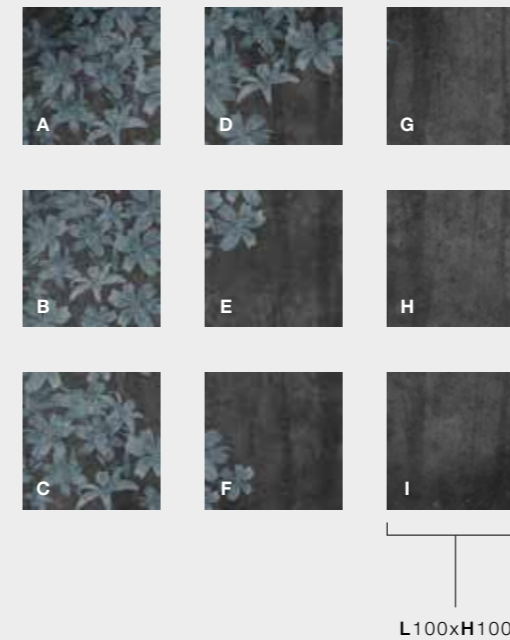

paper collection

Ciascuno dei 3 decori è composto nel suo insieme da 3 sezioni verticali, selezionabili anche singolarmente, realizzate in carta da parati.

*Anyone of the 3 motifs is composed by 3 vertical sections of wallpaper.
The can also be sold singularly.*

CHERRY



L100xH300



L300xH300

CALYPSO

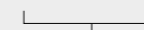
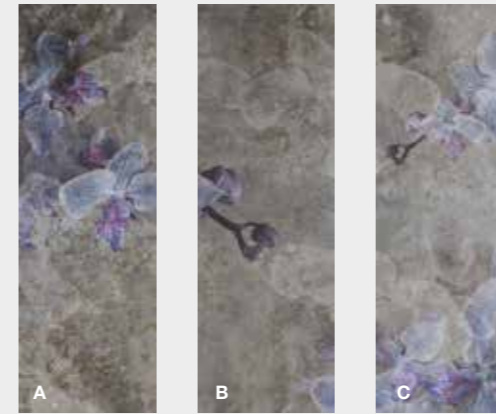

L100xH300

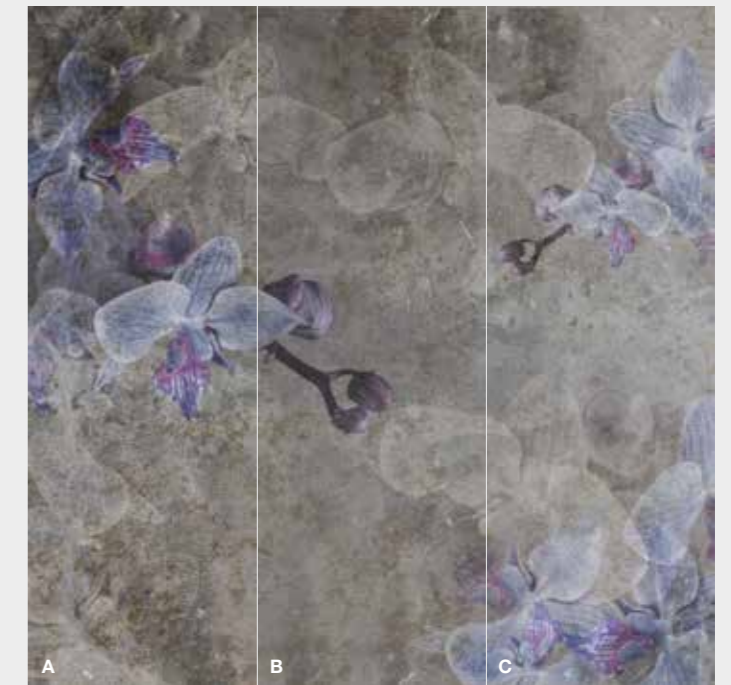

L300xH300

GARDEN



L100xH300

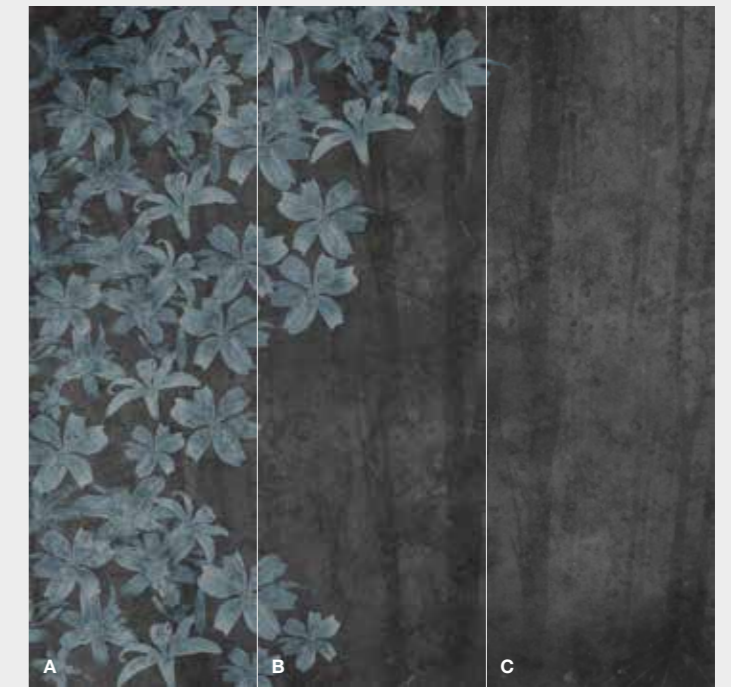

L300xH300

campionario colori | colours chart

top basintop | *tops basintops*



opalite bianco



opalite nero

top | *tops*



specchio 02



specchio fumé grigio



specchio fumé bronzo



cherry



calypso



garden

rivestimenti mobili | *paneling furniture*

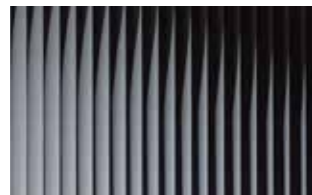

specchio flutes nero



specchio flutes bronzo



specchio flutes bianco



specchio 02



specchio fumé grigio



specchio fumé bronzo



specchio stampato bronzo



specchio stampato grigio

campionario colori | colours chart

rivestimenti mobili | *paneling furniture*



laminam filo ghisa

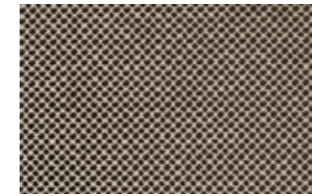

laminam filo argento



laminam filo mercurio



laminam i naturali
bianco statuario



laminam i naturali
calacatta oro



cherry



calypso



garden

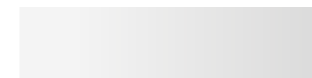

vetro extrachiaro
trasparente



vetro grigio
trasparente



vetro bronzo
trasparente

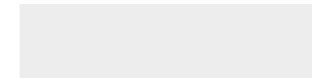

vetro extrachiaro
satinato



vetro grigio
satinato



vetro bronzo
satinato

(solo per coll. *Passepartout*)

finiture parti in metallo | *metals finishes*



peltro PE



bronzo BR

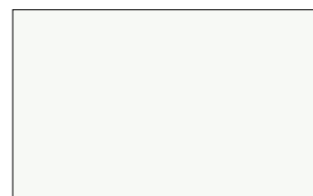

bianco opaco ral 9016
(solo per coll. *Riflessi*)

finiture fianchi | *external sides finishes*



peltro PE



bronzo BR



noce canaletto
(solo per coll. *Passepartout*)



bianco opaco 08
(solo per coll. *Passepartout*)

+skin | composizioni | compositions

cm h30 e h50

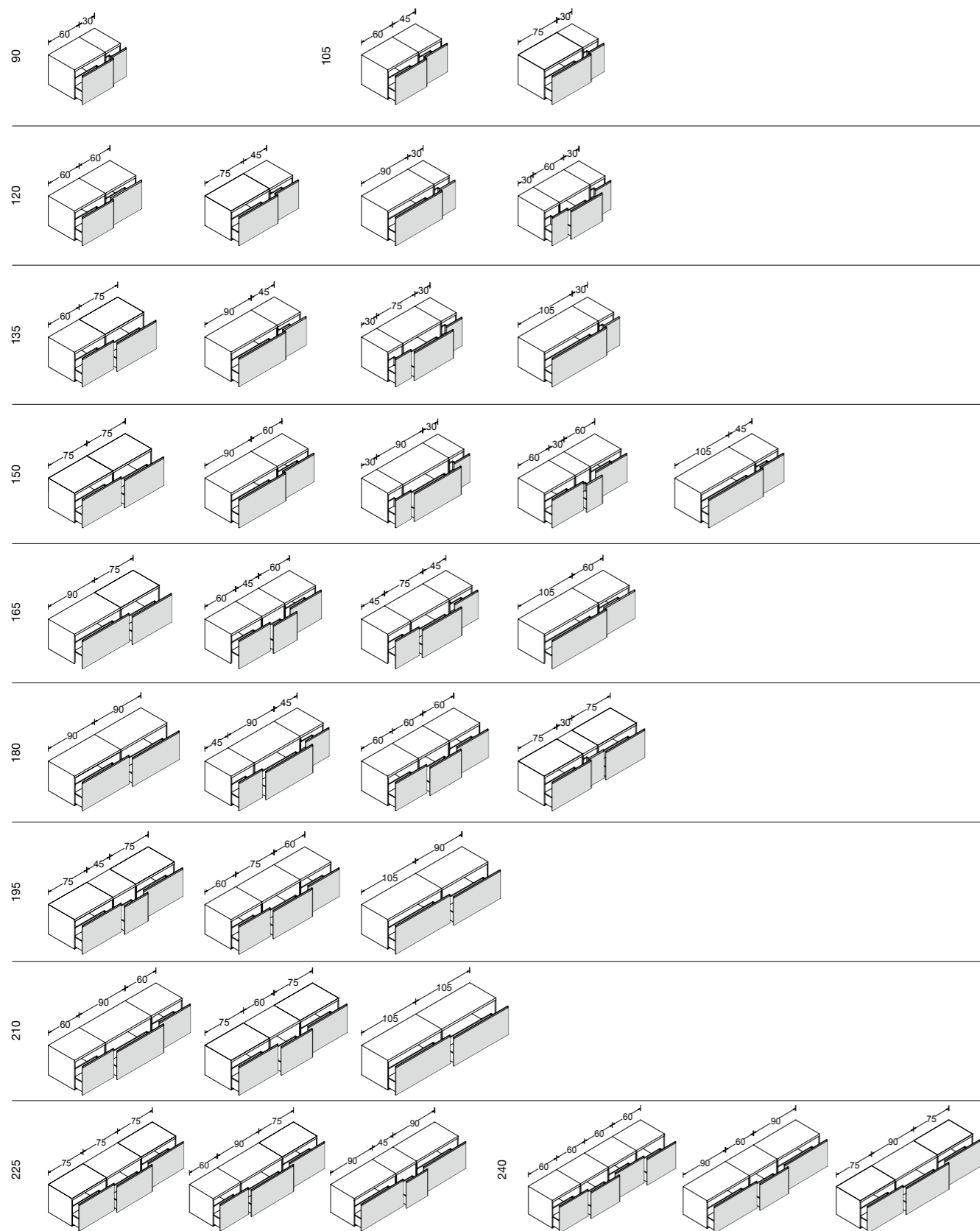

T-60 | composizioni | compositions

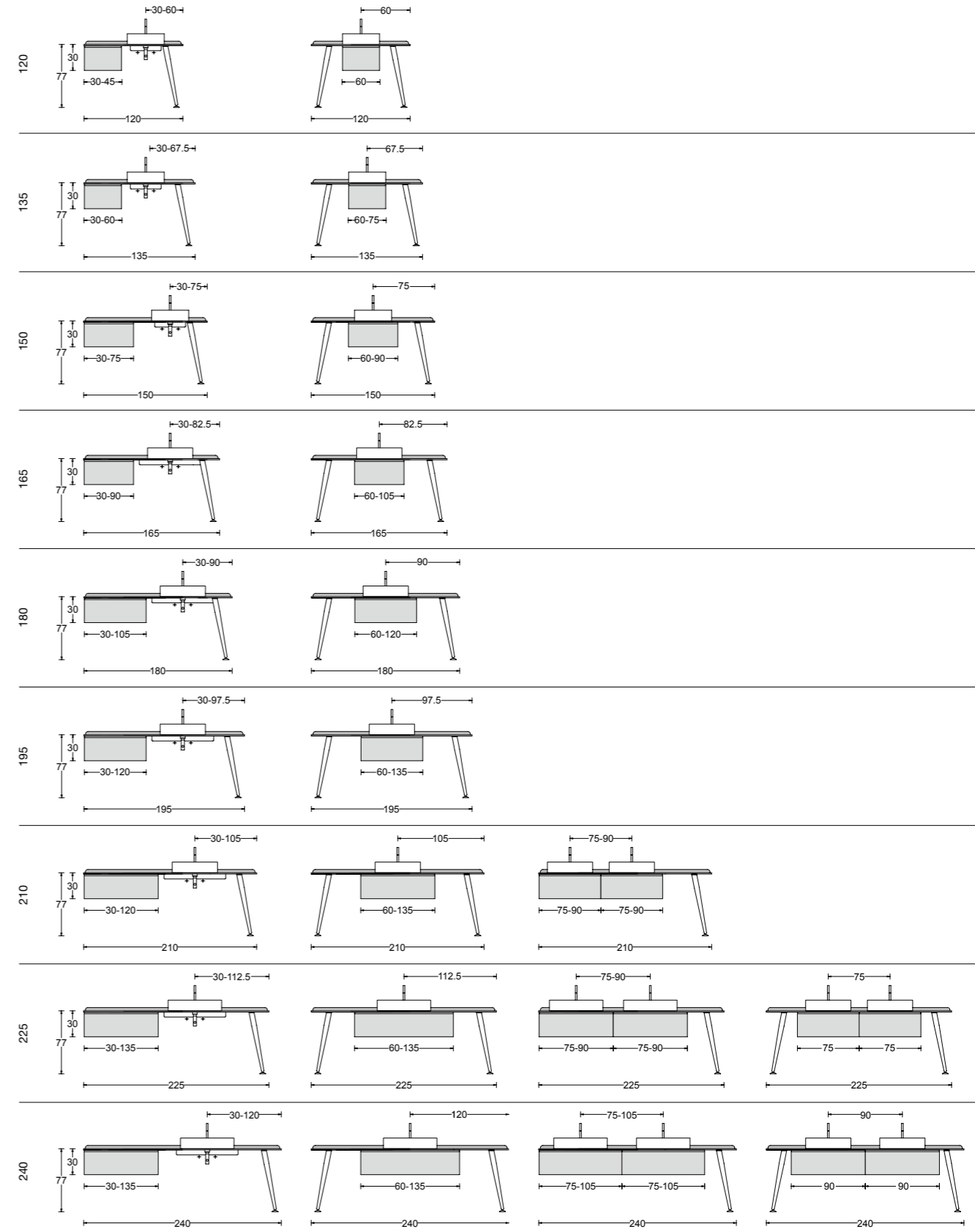

plissé | composizioni | compositions



scarico a parete

scarico a pavimento

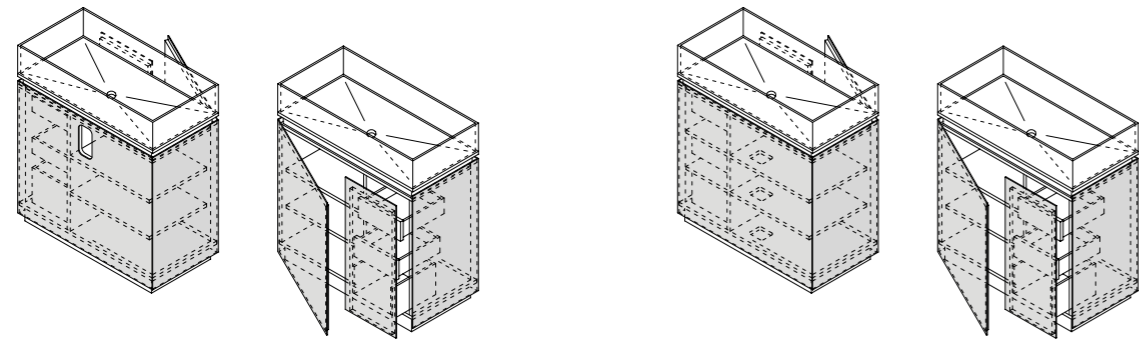

scarico a parete

scarico a pavimento

passepertout | composizioni | compositions

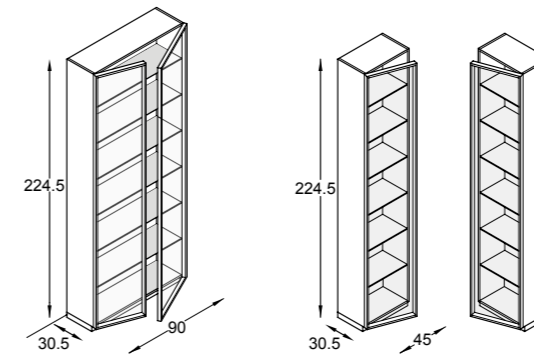

a terra

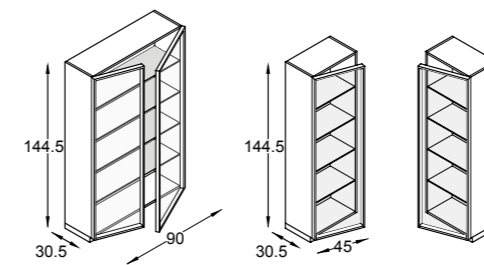

a terra

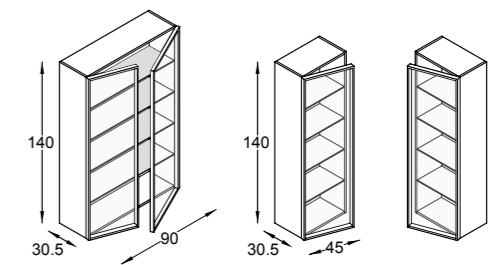

sospesa

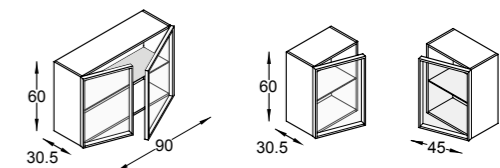

sospesa

design and concept **bizzarridesign** rendering **alessandro falcioni** graphic design **cesare francolini** print **grafiche antiga**