

Your well-being through the elements  
of nature: the regenerating power of water,  
the beneficial effects of heat, the healthy  
power of steam and the positive vibrations  
of the air nourish body and spirit.

# WELLNESS COLLECTION



# Total living Bathroom and Wellness

Gruppo Geromin arreda l'atmosfera di casa con il suo concetto di Total Living Bathroom and Wellness. Un insieme di collezioni, prodotti e finiture che danno forma ad ambienti completi e coordinati: mobili, vasche idromassaggio, box doccia, saune e hammam condividono lo stesso spazio e lo stesso stile.

Gruppo Geromin furnishes the home environment with its concept of Total Living Bathroom and Wellness. A set of collections, products and finishes that give shape to complete and coordinated environments: furniture, hydromassage tubs, shower cubicles, saunas and hammams share the same space and the same style.



Total living bathroom & wellness

# Your Exclusive Space



**“Da oltre 70 anni, Gruppo Geromin impiega materiali di pregio e tecnologie all'avanguardia per progettare e realizzare ambienti wellness e arredo bagno di qualità.”**

“The Geromin Group has been using high-end materials and cutting-edge technology for more than 70 years, to design and create wellness areas and bathroom furniture.”



“We bring a special kind of creativity to what we do, which comes from working as a team. We are all on board the same ship, sailing towards exciting new products, collections and designs. This is the spirit of the Geromin Group, and this is what brings us pleasure every day, as we create exceptional things.”



“Lavoriamo con quella speciale creatività che nasce dalla collaborazione, dal sentirsi tutti parte di un grande equipaggio in navigazione verso l'emozione di un nuovo prodotto, una nuova linea, un nuovo design. E' questo lo spirito che anima il nostro Gruppo, e che ogni giorno ci fa trovare il piacere delle cose fatte a regola d'arte.”

**GEROMIN**  
GRUPPO

VENEZIA 1945



## Un processo industriale solido ed efficace

Le aree operative del Gruppo Geromin si estendono su 20.000 mq, nei quali l'attenzione artigianale che da sempre ci contraddistingue, convive con sistemi produttivi e logistici all'avanguardia e a basso impatto ambientale. In questo modo garantiamo massima qualità ed efficienza a partire dalla produzione fino alla consegna. Dalla linea produttiva ai magazzini, l'utilizzo di macchinari tecnologicamente avanzati e il rispetto di elevati standard di efficienza consente la massima precisione nella realizzazione di prodotti di alta qualità e nella loro spedizione.



### A solid and effective industrial process

Gruppo Geromin production areas extend over 20,000 sq. m., where craftsmanship goes hand in hand with cutting-edge production and logistics systems with a low environmental impact. In this way, we can guarantee the highest quality and efficiency, from manufacturing to delivery. From the production line to the warehouses, the use of technologically advanced machinery and compliance with the highest efficiency standards allow maximum precision in the realization of high quality products and their shipment.

## Una rete distributiva estesa e consolidata

Grazie ad un impegno costante e a continui investimenti nelle strategie commerciali, nella rete distributiva e in una puntuale assistenza al consumatore, il Gruppo ha consolidato la presenza dei propri prodotti nei mercati di tutto il mondo.

### A widespread and consolidated network

Thanks to a constant commitment and continuous investments in commercial strategies, in the distribution network and in prompt customer assistance, the Group has strengthened the presence of its products in markets all over the world.



# 3 Brand per un unico grande gruppo

3 brands for one great group



## Wellness & Shower

Hafro parte dall'idea dell'acqua come elemento fondamentale della cura del corpo per realizzare vasche idromassaggio, minipiscine, hammam, generatori di vapore, box doccia multifunzione e sistemi doccia completi.

Hafro starts from the idea of water as a fundamental element for body care to create hydromassage tubs, mini-pools, hammams, steam generators, multifunction shower cabins and complete shower systems.



## Bathroom & Laundry

Geromin è il marchio che interpreta l'arredo bagno e la lavanderia con soluzioni pratiche e materiali di qualità, dando vita a linee di prodotti versatili che rendono gli ambienti di servizio della casa sempre più funzionali.

Geromin is the brand that interprets bathroom furniture and laundry rooms with practical solutions and quality materials, creating versatile product lines that make more and more functional every service room of the house.



## Heat & Health

Attraverso la sapiente mescolanza di legni pregiati e finiture speciali, Sauna Vita® crea saune e hammam dalle eccellenti prestazioni, nel rispetto dell'antica tradizione del benessere legata alla Sauna Finlandese e al Bagno Turco.

Thanks to the skillful blend of fine woods and special finishes, Saunavita creates saunas and hammams with excellent performance, in accordance with the long-standing tradition of well-being linked to the Finnish Sauna and the Turkish Bath.

# WELLNESS

indice collezioni  
collection index



page 025

## Saune e hammam / Saune

Saunas and hammam /  
Saunas

page 98

## Hammam

Ghibli

page 166

## Soffione emozionale

Multi-sensory shower head

page 170

## Doccia scozzese

Bucket shower



page 175

## Hammam

Sv Steam

SAUNAVITA®  
calore naturale



page 201

## Hammam

Linea Rigenera  
G-Steam  
Gemini

HAFRO®  
acqua, per piacere



page 251

## Box doccia multifunzione

Multifunction  
shower cabins



page 279

## Vasche idromassaggio

Hydromassage bathtubs



page 407

## Vasche combinate

Bathtubs with crystal glass  
shower cabin



page 416

## Soprasvasca Time

Time bath screen

page 418

## Rubinetteria Finiture / Tastiere

Taps / Finishes  
Display panels

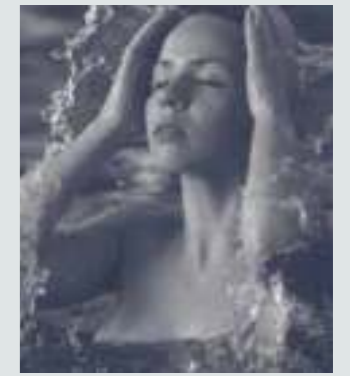

page 447

## Vasche ad incasso

Built-in bathtubs

**La natura è la  
nostra fonte  
di ispirazione.  
La vitalità  
dell'acqua,  
le proprietà del  
calore e i benefici  
del vapore  
per un perfetto  
equilibrio tra  
corpo e mente.**

*Nature is our source of inspiration.  
The vitality of water, the properties of  
heat and the benefits of steam for a  
perfect balance between body and mind.*



**Gruppo Geromin Inspired by nature**

# ISPIRARSI ALLA NATURA

*Inspired to nature*

La natura racchiude in sé tutti gli elementi necessari a ristabilire l'equilibrio tra corpo e mente, equilibrio che troppo spesso perdiamo per rimanere al passo con i ritmi frenetici della vita moderna. Per questo, sempre più persone cercano modi e momenti per creare un dialogo con la natura. Dal legno, dall'aria, dall'acqua e dal fuoco derivano effetti benefici e risanatori che fin dai tempi antichi l'uomo ha imparato a sfruttare a proprio favore. La nostra ricerca nel mondo delle saune è innanzitutto un ritorno alla natura attraverso la scelta dei legni più pregiati, per presentare la forma più evoluta di un antico rituale di benessere. Le nostre saune rappresentano un modo per entrare in contatto con gli elementi attraverso i principi salutari racchiusi in essi. Abbandonandosi al caldo abbraccio di questa pratica millenaria si riscoprono sensazioni da tempo dimenticate, come il profumo del legno e le sue vibrazioni naturali, sprigionate dalle elevate temperature del calore secco, capaci di nutrire il corpo e lo spirito, restituendoci armonia e serenità.

*Nature holds all the elements to restore the balance between body and mind. A balance that we often lose when we attempt to keep up with the hectic pace of day-to-day life. That's why an increasing number of people are looking for ways and moments to connect with nature. Humans have been using the beneficial effects of wood, air, water, and fire since the dawn of times. Our research in the world of sauna is, first of all, a return to nature through the selection of the finest wood to achieve the most advanced form of an ancient ritual. Our saunas are a wonderful way to connect with the elements and their beneficial principles. The warm embrace of this ancient ritual will make you rediscover long-forgotten sensations, such as the scent of wood and the natural vibrations released by dry heat. Vibrations that nourish body and soul, restoring harmony and serenity.*





# UN RITUALE ANTICO MA ATTUALE

*An ancient yet modern ritual*



Le origini della sauna risalgono al XII secolo, in Finlandia, dove le temperature rigide la rendevano una vera e propria necessità. Già allora erano noti i benefici apportati dall'aria calda e secca sulla salute di corpo e mente, tanto che a questi ambienti veniva attribuito un valore sacro. Dall'antichità, la pratica della sauna è arrivata fino ad oggi, evolvendosi nelle tecnologie e nei materiali, ma rimanendo un efficace rituale di benessere.

*The origins of the sauna date back to the 12th century, in Finland, where the low temperatures made it a real necessity. Even then, the benefits of hot and dry air on the health of body and mind were known, so much so that a sacred value was attributed to these environments. Today the sauna has evolved in terms of technology and materials, but remaining an effective wellness ritual.*

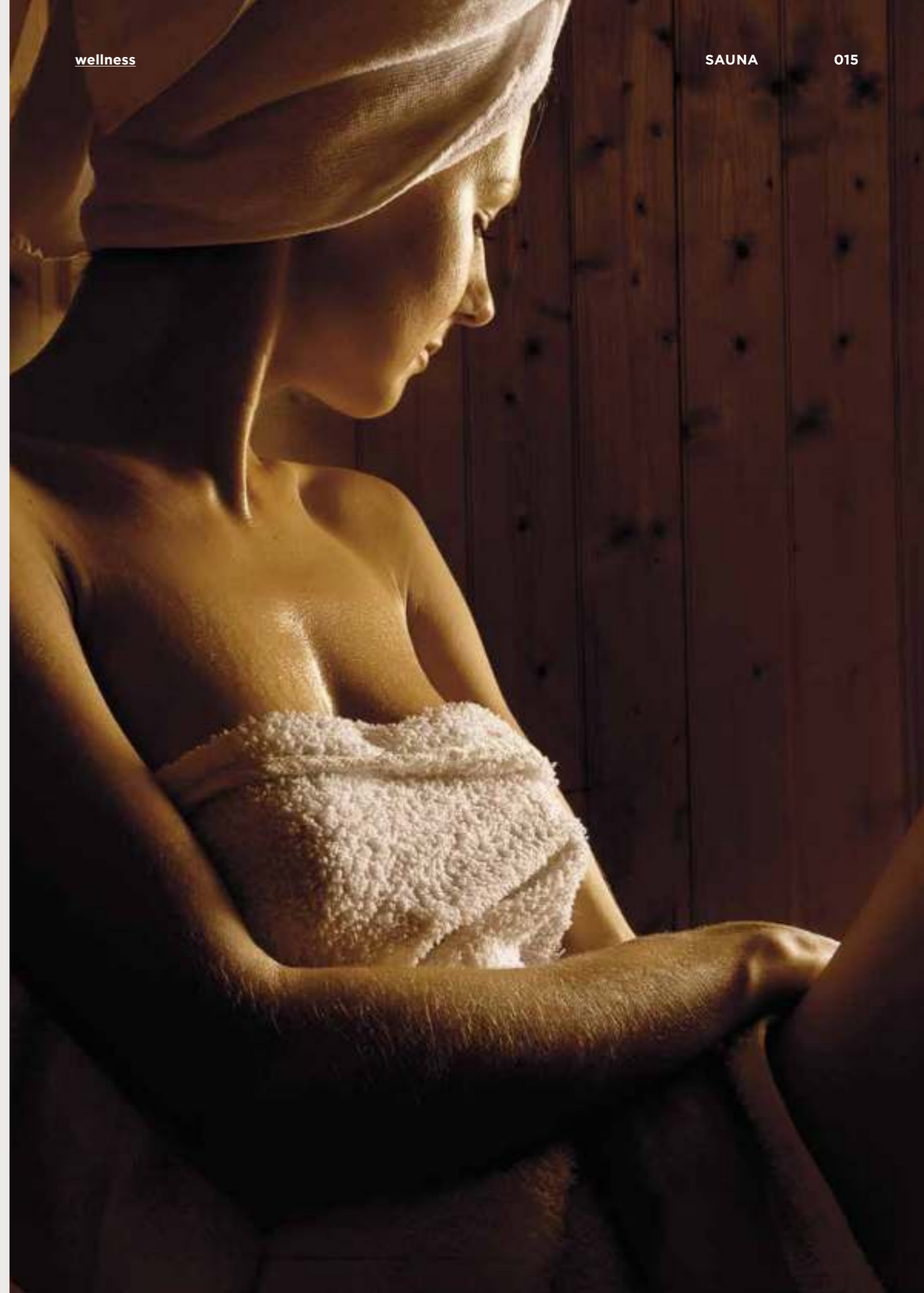

# Nelle saune e negli hammam ci ispiriamo alla natura per ricreare microclimi con il giusto rapporto tra temperatura e umidità.

Saunas and hammams: we are inspired by nature to recreate microclimates with the right balance of temperature/ humidity ratio.

## Hammam

Nel bagno turco l'umidità raggiunge il 100% e le temperature non superano i 45°C.

*In Turkish bath the humidity reaches 100% and the temperatures do not exceed 45°C.*

Umidità  
humidity

90% > 100%

40°C > 45°C

## Sauna

Nella sauna il calore può raggiungere temperature fino ai 95°C, ma grazie alla bassa umidità (20-30%) rilassa la muscolatura e favorisce la depurazione dell'organismo.

*In the sauna the heat can reach temperatures up to 95°C, but thanks to the low humidity (20-30%) it relaxes the muscles and favors the purification of the organism.*

Umidità  
humidity

20% > 30%

90°C > 95°C

## Biosauna

La Biosauna è una sauna con livelli di temperatura contenuti tra i 50 e i 60°C e un'umidità di circa 60-70%. La stufa Bio crea l'equilibrio perfetto fra calore ed umidità.

*Biosauna is a sauna with temperature levels between 50 and 60°C and a humidity of about 60-70%. The Bio stove creates the perfect balance between heat and humidity.*

50°C > 60°C

60% > 70%

Umidità  
humidity



# BENEFICI PER TUTTO IL CORPO

*Benefits for the whole body*

Le alte temperature e il basso tasso di umidità hanno effetti benefici sulla salute dell'intero organismo. La sauna attiva la sudorazione contribuendo all'eliminazione delle tossine e, allo stesso tempo, favorisce la circolazione rilassando e allentando la tensione dei muscoli. Fare la sauna 2-3 volte alla settimana per 15-20 minuti fa bene al corpo e anche alla mente, perché diminuisce gli stati d'ansia e migliora l'umore.

*The high temperatures and low humidity have beneficial effects on the health of the whole organism. The sauna activates sweating, contributing to the elimination of toxins and, at the same time, facilitates circulation by relaxing and relieving muscle tension. Taking a sauna 2-3 times a week for 15-20 minutes is good for your body and mind, because it reduces anxiety and improves mood.*

# PROGETTI SPA SU MISURA

*Spa tailor-made projects*



Ogni momento di benessere è unico grazie a soluzioni su misura e personalizzazioni speciali. Sauna Vita crea ambienti wellness completi con sistemi progettati appositamente per qualsiasi tipo di spazio ed esigenza.

*Every moment of well-being is unique thanks to tailor-made solutions and special customizations. Sauna Vita creates complete wellness environments with systems specifically designed for any type of space and requirement.*

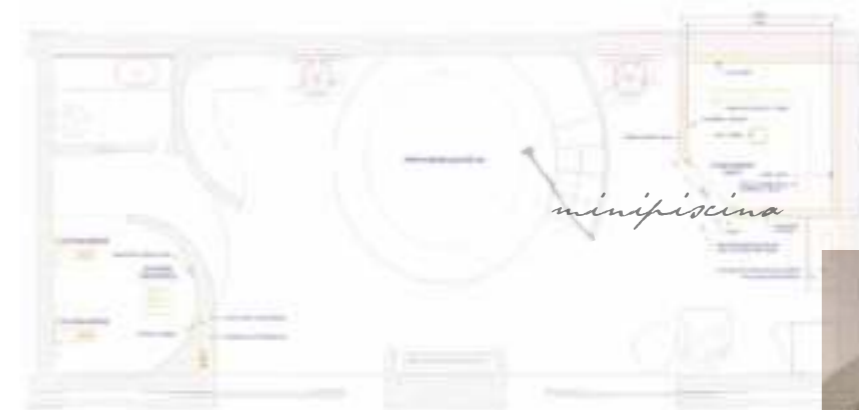

## MASSIMA PERSONALIZZAZIONE PER SPAZI PROFESSIONALI

Veri e propri progetti di interior design dedicati agli ambienti professionali: l'alta qualità dei materiali, design esclusivi e tecnologie all'avanguardia diventano un tutt'uno e danno forma a spazi wellness personalizzati in ogni misura e dettaglio.

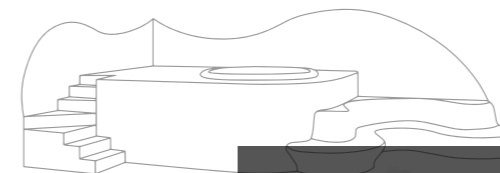

## Extreme customisation for professional settings

Real interior design projects for professional environments: high-quality materials, exclusive designs and cutting-edge technologies give shape to customized wellness spaces for every size.



*Spa + Hammam*

# PIÙ FUNZIONALITÀ AL BENESSERE

*When wellness becomes functional*



## ACCESSORI E COMPLEMENTI *Accessories and complements*

Dall'esclusiva chaise longue alla panca e al tavolino in legno e fuselli in faggio con struttura in acciaio inox o verniciato, dai comodi poggiaschiena e poggiatesta agli accessori per la gestione della sauna, ogni elemento è progettato per darti il massimo del comfort.

*Exclusive chaise longues, wooden benches and tables, beech spindles with a stainless steel structure, comfortable backrests and headrests, and sauna-management accessories. Every element is designed to ensure the utmost comfort.*



Una ricca collezione di accessori e complementi rende ancora più funzionale - e personale - il bagno turco e la sauna. Finiture coordinate, design ergonomici e oggetti utili arredano lo spazio e danno ancora più valore al benessere.

*A rich collection of accessories to make Turkish baths and saunas an even more functional and personal experience. Matching finishes, ergonomic design, and useful items furnish the space, enhancing the value of wellness.*



# SAUNE E HAMMAM

SAUNAS AND TURKISH BATH

---

**Olimpo** sauna + hammam <sup>034</sup>

**Ethos** sauna + hammam <sup>054</sup>

**Ethos C | Ethos L** sauna + hammam <sup>072</sup>

**Ghibli sauna** sauna <sup>090</sup>

**Ghibli hammam** hammam <sup>098</sup>

**Kalika** sauna <sup>108</sup>

**Cuna doccia** sauna + doccia <sup>126</sup>

**Cuna** sauna <sup>134</sup>

**Talia** sauna <sup>142</sup>

**Kyra** sauna <sup>148</sup>

**Outdoor** sauna <sup>162</sup>

---

**Soffione emozionale** <sup>166</sup>  
*Multi-sensory shower head*

**Doccia scozzese** <sup>170</sup>  
*Bucket shower*

# RISPETTO PER L'AMBIENTE

*Environmentally-friendly*

Il rispetto per la natura è da sempre una nostra priorità. Per questo ogni ambiente wellness è realizzato adottando processi produttivi etici e sfruttando legnami provenienti da piantagioni ecologiche.

*We love and respect nature. That's our priority. Every wellness space is created using ethical production processes and wood from sustainable crops.*

SAUNAVITA®  
calore.naturale



## RAPPORTO TEMPERATURA - UMIDITÀ

*Temperature-humidity ratio*

Nelle saune e hammam ci ispiriamo alla natura per ricreare dei microclimi con il giusto rapporto tra temperatura e umidità, in modo da trasmettere tutta l'armonia degli ambienti wellness.

*Our saunas and Turkish baths are inspired by nature to recreate microclimates with the perfect temperature-humidity ratio, so as to provide the same harmony as wellness settings do.*

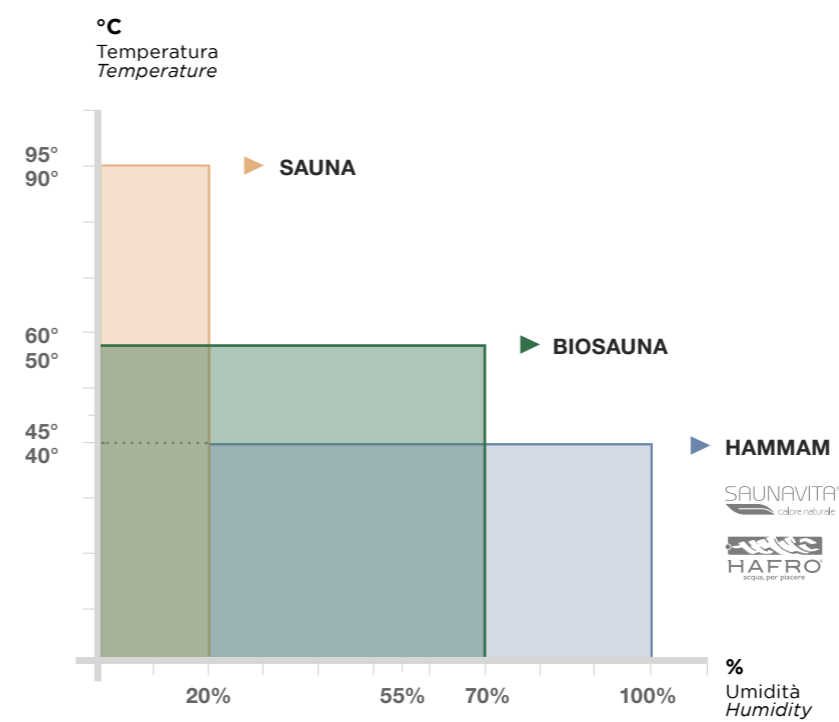

## ACCESSORI E OPTIONAL

### Accessories and optional



#### MASTELLO E MESTOLO

Due accessori indispensabili nelle saune tradizionali. L'acqua contenuta nel mastello viene versata sulle pietre per la vaporizzazione.

#### Bucket and ladle

Two must-have accessories in traditional saunas. The water contained in the bucket is poured onto stones, and evaporates.



#### TERMOIGROMETRO

Installato all'interno della sauna, il termoigrometro è uno strumento che permette di controllare la temperatura e l'umidità.

#### Thermo-hygrograph

The thermo-hygrograph is installed inside the sauna and controls both temperature and humidity.



#### CLESSIDRA

La clessidra segna tempo è lo strumento fondamentale per misurare la permanenza all'interno dell'ambiente sauna.

#### Hourglass

The hourglass is essential to measure your stay inside the sauna.



#### POGGIASCHIENA

Un pratico ed ergonomico supporto per il corpo che arreda la sauna e costituisce un comodo appoggio.

#### Backrest

A practical and ergonomic support for your body and a wonderful piece of furniture for your sauna.



#### PANCA CON LUCE LED

Un sottile fascio di luce lungo il lato della panca contribuisce a creare un'atmosfera rilassante nella sauna.

#### Bench fitted with a led light

A thin light beam along the side of the bench creates a relaxing atmosphere in the sauna.



#### LAMPADA INTERNA

La lampada interna alla sauna è un accessorio decorativo e diffonde la luce con un particolare effetto raggiato.

#### Internal lamp

The sauna's internal lamp is not just a decoration, but it also creates a unique ray effect.

## TEMPERATURE NELLA SAUNA

### Temperatures In the sauna

All'interno dell'ambiente sauna il costante ricircolo d'aria fresca determina diversi livelli di calore: il punto più caldo è all'altezza del soffitto, mentre vicino al pavimento la temperatura è simile a quella esterna.

The constant recirculation of fresh air inside the sauna generates different heat levels. The ceiling is the hottest point, whereas the temperature near the flooring is similar to the exterior one.

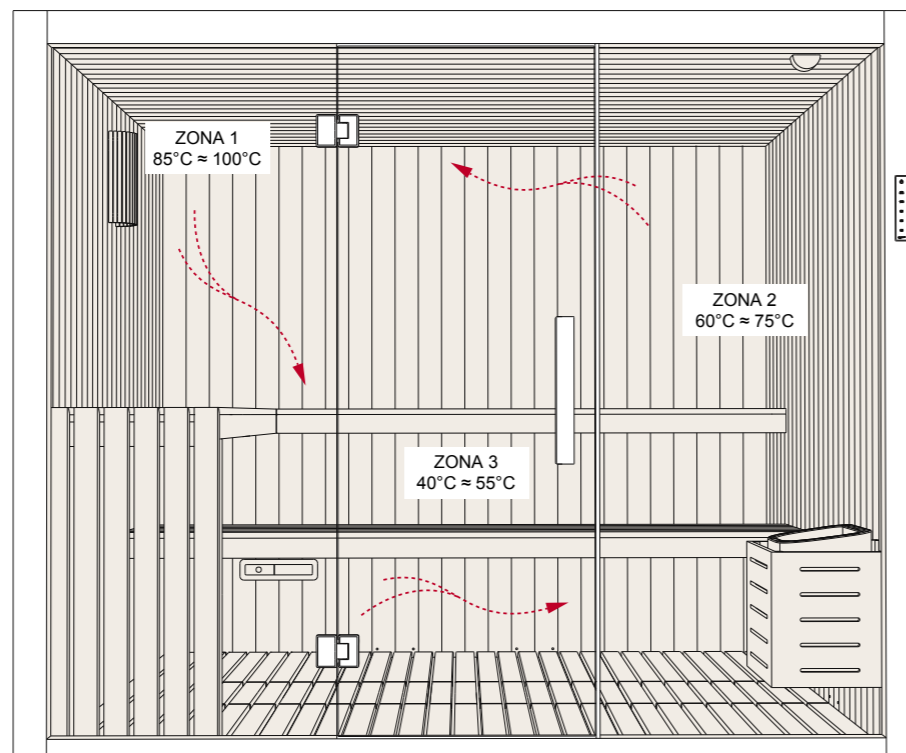

## LA QUALITÀ SUPERIORE DI UN PRODOTTO SAUNA VITA

### The superior quality of a Sauna Vita product

La coibentazione delle pareti perimetrali e del soffitto della sauna viene realizzata con lana di roccia e legno naturale per evitare la dispersione del calore. Il sistema di montaggio è facile e veloce: ogni singolo componente è già stato collaudato precedentemente in azienda e tutti i pezzi si incastrano in modo veloce ed univoco tra loro per garantire un montaggio a regola d'arte.

The sauna's perimeter walls and ceiling are insulated with rockwool and natural wood to prevent heat dissipation. The assembly system is quick and easy: every single component has already been tested beforehand in the factory and all the pieces fit together quickly and unequivocally to ensure a perfect assembly.

Lana di roccia  
Rock wool



Legno naturale  
Natural wood





# L'IMPORTANZA DEL LEGNO

*The importance of wood*

La tradizione vuole che le saune siano costruite in legno.

Un materiale versatile e ricco di proprietà benefiche, che continua a vivere anche dopo l'abbattimento della pianta, perfetto per conservare e propagare il calore. Un'attenta ricerca tra le molte varietà disponibili e la lunga esperienza nel settore, ci hanno portato a selezionare per le nostre saune i legnami migliori, resistenti alle alte temperature e caratterizzati da profumi avvolgenti e rilassanti. Oltre agli aromi naturali, il legno propaga vibrazioni sonore che entrano in contatto con le vibrazioni naturali del corpo, creando un'atmosfera armonica di puro piacere.

*According to tradition, a sauna should be made of wood. A versatile material with multiple beneficial effects that continue even after a tree has been felled. Perfect for storing and propagating heat. Our research and experience have led us to select the best, most fragrant timber for saunas to ensure relaxing and enveloping moments. In addition to its natural aromas, wood propagates sound vibrations that come into contact with the body's natural vibrations, thereby creating a harmonious atmosphere of pure pleasure.*

## FINITURE

*Finishes*



### Abachi

Un legno molto resistente agli sbalzi di temperatura e a zero trasmissibilità termica.  
*A wood extremely resistant against temperature changes and with zero thermal conductivity.*



### Abete

Un legno profumato per creare ambienti estremamente naturali e rilassanti.  
*A scented wood is used to create natural and extremely relaxing settings.*



### Hemlock

Un legno pregiato, privo di nodi, resistente e dalla tonalità calda. Garantisce la massima coibentazione termica.  
*A fine, knot-free, and resistant wood with a warm colour. Hemlock ensures extreme thermal insulation.*



### Abete nodato

I nodi dell'Abete risaltano l'autenticità del legno e valorizzano la naturalezza della sauna.  
*The knots of the spruce wood the authenticity of the material and the naturalness of the sauna.*



### Cedro + Frassino Termotrattato

Il profumo del Cedro diffonde all'interno della sauna l'aroma della natura. Il Frassino termotrattato conferisce ulteriore resistenza.

*The natural scent of the cedar is spread all over the sauna. The heat-treated ash wood provides further resistance.*

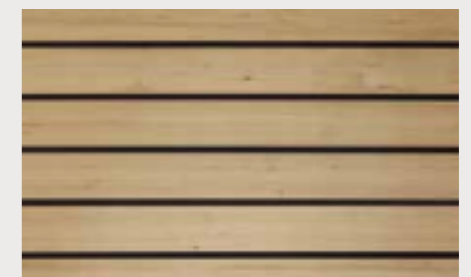

### Hemlock + Frassino Termotrattato

Il trattamento termico del Frassino migliora le caratteristiche di durabilità del legno e si unisce alla resistenza dell'Hemlock.

*The thermal treatment of ash wood improves its durability, which adds to the Hemlock's resistance.*

# SUPERFICI SPECIALI INTERNE ED ESTERNE

*Special internal and external surfaces*

Materiali innovativi dalla grande resa estetica e dalle elevate performance caratterizzano le finiture esterne degli ambienti wellness e l'interno di box doccia e hammam. Per questi ambienti costantemente sottoposti a sollecitazioni termiche, abbiamo scelto delle superfici ad alto contenuto tecnologico che, oltre ad essere molto resistenti e a mantenere inalterate le loro proprietà nel tempo, risultano belle da vedere e piacevoli da toccare. Per ambienti funzionali e ricchi di stimoli tattili e visivi.

*Beautiful, innovative, and high-performance materials characterize the external finishes of wellness settings and the inside of shower cabins and Turkish baths. For these environments that are constantly subjected to thermal stress we have chosen surfaces that, in addition to being very resistant, maintain their properties unchanged over time and are pleasing to the eye and the touch.*



Anti-impronta  
Anti-fingerprint



Bassa riflessione  
Low reflection



Alta resistenza  
High resistance



Resistenza al calore  
Resistance to heat



Facile pulizia  
Easy to clean

SAUNAVITA®  
calore.naturale

## FINITURE

*Finishes*



Struttura esterna ed interna  
Spazio doccia e hammam  
Exterior and interior structure  
Shower space and hammam



Struttura esterna ed interna  
Spazio doccia e hammam  
Exterior and interior structure  
Shower space and hammam



Struttura esterna ed interna hammam  
Exterior and interior hammam structure

### Fenix

Un materiale innovativo e resistente per i progetti wellness: con una bassa riflessione della luce, le superfici sono opache, anti-impronte e soft touch.

*An innovative and resistant material for wellness projects: with a low reflection of light, the surfaces are matt, anti-fingerprint and soft touch.*

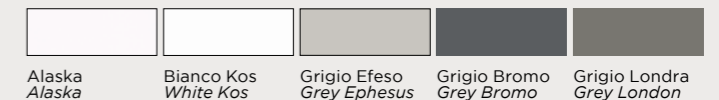

Alaska  
Alaska

Bianco Kos  
White Kos

Grigio Efeso  
Grey Ephesus

Grigio Bromo  
Grey Bromo

Grigio Londra  
Grey London

### Grigio Cosmico

Una finitura costituita da uno speciale laminato dalle alte prestazioni, altamente impermeabile, resistente e con una resa estetica unica.

*A finish consisting of a special high performance laminate, highly waterproof, durable and with a unique aesthetic result.*

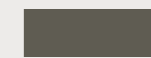

Grigio Cosmico  
Cosmic Grey

### Solid Surface

Un materiale simile alla pietra naturale, composto da minerali naturali e resine acriliche ad alta resistenza, crea superfici solide di nuova generazione.

*A material that is similar to natural stone. It is made up of natural minerals and high-resistance resins, and creates state-of-the-art solid surfaces.*

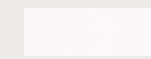

Bianco  
White

# OLIMPO

design Franco Bertoli

La rivoluzione nel mondo della sauna e del bagno turco è realtà: un vero e proprio hammam, con doccia e vasca idromassaggio integrati, viene affiancato da un ambiente sauna per un percorso benessere completo. La vasca interna al bagno turco ha un innovativo sistema di idromassaggio MicroSilk® che avvolge il corpo di micro-bolle benefiche: un elisir di giovinezza per il corpo e per la mente.

*A revolution in the world of saunas: a true Turkish bath with built-in shower and whirlpool bath combined with a sauna setting for a complete wellness path.*

*The tub inside the Turkish bath is equipped with MicroSilk®, an innovative whirlpool system that covers the body with beneficial microbubbles.*

*A true youth elixir for your body and mind.*

**Una vasca interna al bagno turco:  
la nuova frontiera dell'idroterapia infonde piacevoli  
e autentiche sensazioni di benessere.**

*the new frontier of hydrotherapy that instils  
pleasant and authentic feelings of well being.*





## Olimpo

collection

**DIMENSIONI**  
395x150x215 H  
(hammam 195 cm - sauna 200 cm)

**CARATTERISTICHE**  
hammam con doccia  
e vasca integrata + sauna

**DIMENSIONS**  
395x150x215 H  
(hammam 195 cm - sauna 200 cm)

**SPECIFICATIONS**  
hammam with shower  
and integrated bath + sauna



Una pratica e comoda copertura pieghevole trasforma la vasca in un lettino, se completamente disteso, o in una confortevole seduta, se parzialmente aperto. Può essere usato anche come pratico poggiatesta.

*A practical and comfortable cover cushion transforms the bath into a lounger, when fully extended, or into a comfortable seat, if partially opened. It can also be used as a headrest.*

## VASCA CON SISTEMA DI IDROMASSAGGIO MICROSILK® Tub with microsilk® whirlpool system

Microsilk® è la nuova frontiera dell'idroterapia, un'autentica fonte di benessere e giovinezza. Un getto speciale produce una nuvola di microbolle di ossigeno che idrata la pelle e ha effetti benefici sulla respirazione. (per altre informazioni vedi pag. 280)

*Microsilk® is the new frontier of hydrotherapy. An authentic source of wellness and youth. A special jet forms a cloud of oxygen micro bubbles, which hydrates the skin and has beneficial effects on breathing. (for more information see page 280)*

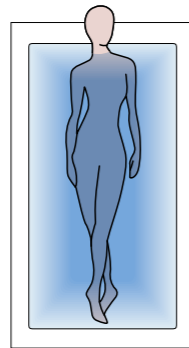

Rilassamento senza getti idromassaggio  
Relax without whirlpool jets

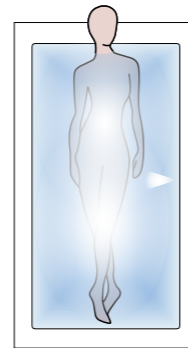

Sistema idromassaggio Microsilk® acceso  
Microsilk® hydromassage system on

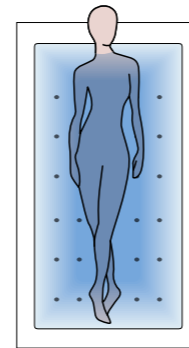

Idromassaggio airpool  
Airpöll hydromassage

## Olimpo collection

Soffioni sequenziali,  
attivabili tramite tastiera.

*Sequential head showers,  
managed by the display panel.*



## Olimpo

collection



Tastiera per l'attivazione delle funzioni Microsilk®, Airpool (accessorio), soffioni sequenziali e rubinetteria termostatica per funzioni hydro.

*Keypad for activating the Microsilk®, Airpool (accessory), sequential showerheads and thermostatic taps for hydro functions.*

### Erogatore di vapore con aromaterapia

*Steam generator with aromatherapy*

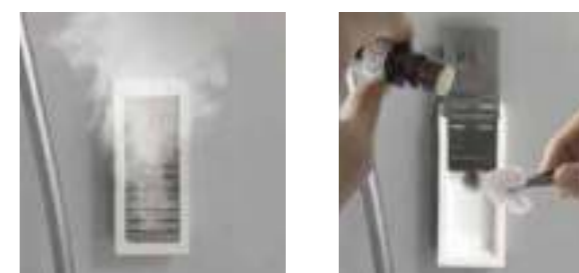

Aggiungendo essenze e aromi all'erogatore di vapore si aumentano i benefici del bagno turco.

*By adding essences and aromas to the steam generator, you increase the benefits of the Turkish bath.*

# Olimpo

collection



**DIMENSIONI**  
395x150x215 H

**CARATTERISTICHE**  
hammam con doccia  
e vasca integrata + sauna

**DIMENSIONS**  
395x150x215 H

**SPECIFICATIONS**  
hammam with shower  
and integrated bath + sauna



La stufa "a torre" con pietre laviche fa raggiungere la temperatura ideale all'ambiente in maniera più veloce e costante rispetto ad una stufa tradizionale. Per un notevole risparmio di energia.

*The "tower" stove with lava stones creates the ideal temperature more quickly and consistently compared to traditional ones, allowing for considerable energy savings.*



INTERNO



ESTERNO

La maniglia ha una doppia finitura: l'interno in legno si armonizza con il calore della sauna e l'esterno in alluminio ne richiama i profili.

*The handle has a double finish. The wood of the inside merges with the heat of the sauna, while the aluminium of the outside matches the profiles.*





Touch screen LCD



Touch screen LCD display per il comando remoto delle funzioni.  
LCD touch screen display to manage every function.

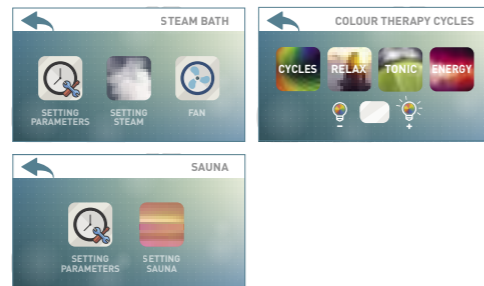

Olimpo  
collection

La cromoterapia per una raffinata pratica di benessere.

Chromotherapy for a pleasant and refined wellness.

# Olimpo

collection



**DIMENSIONI**  
195x150x215 H

**CARATTERISTICHE**  
hammam con doccia  
e vasca integrata

**DIMENSIONS**  
195x150x215 H

**SPECIFICATIONS**  
hammam with shower  
and integrated bath

# Olimpo

Sistema combinato da due moduli:

**Hamмам (con doccia e vasca integrata) + Sauna**

System made up of two modules:

**Turkish bath (with shower and integrated bath) + Sauna**

## DIMENSIONI

395x150x215 H  
Hamмам 195 cm - Sauna 200 cm  
Potenza max:  
Hamмам 4 kW - Sauna 4,5 kW -  
Vasca 1,3 kW

355x150x215 H  
Hamмам 195 cm - Sauna 160 cm  
Potenza max:  
Hamмам 4 kW - Sauna 4,5 kW -  
Vasca 1,3 kW

## INSTALLAZIONE

Parete - Angolo - Nicchia

## MEASUREMENT

395x150x215 H  
Turkish bath 195 cm - Sauna 200 cm  
Max power: Turkish bath 4 kW -  
Sauna 4.5 kW - Tub 1.3 kW

355x150x215 H  
Turkish bath 195 cm - Sauna 160 cm  
Max power: Turkish bath 4 kW -  
Sauna 4.5 kW - Tub 1.3 kW

## INSTALLATION

Wall - Corner - Niche

## CARATTERISTICHE

Basamento con piedini regolabili  
Maniglie in alluminio / alluminio legno  
Pannello di controllo (sauna e bagno turco) touch screen in vetro serigrafato  
Sistema audio con bluetooth  
Sauna con mestolo e mastellino in legno  
Stufa con pietre  
Cromoterapia diffusa a Led RGB con 3 cicli, cambio colore automatico e funzione iride a 42 colori  
Poggiaschiena double-face  
Spazio doccia con bagno turco e vasca con sistema MicroSilk®  
Soffione in acciaio 30x30  
Cascata  
Rubinetteria termostatica con doccino  
2 Cuscini coprivasca con funzione di seduta  
Aspiratore  
4 soffioni sequenziali posizionati sopra la vasca  
Riempimento della vasca con ETP

## SPECIFICATIONS

Base with adjustable feet  
Handles in aluminum / aluminum wood  
Screenprinted glass touch-screen display panel (sauna and Turkish bath)  
Audio system with bluetooth  
Sauna with wooden ladle and small tub  
Stove with stones  
RGB Led chromotherapy with 3 cycles, automatic colour change and 42-colour iris function  
Reversible backrest  
Shower area with Turkish bath and tub with MicroSilk®  
Shower-head system in steel 30x30  
Waterfall  
Thermostatic tap with hand shower  
2 folding pillows to cover the bathtub and to lie above or sit  
Extractor fan  
4 sequential head showers above the bathtub  
Bathtub water filling through the overflow

## FINITURE

Esterno: spazio doccia rivestito in Fenix; cristallo temperato da 8 mm con profili in alluminio brillantato  
Interno: Sauna con arredamento e rivestimenti in abachi; spazio doccia con bagno turco rivestito in Fenix  
Vasca in acrilico Bianco lucido con sistema MicroSilk®  
2 cuscini in ecopelle Antracite

## FINISHES

Exterior: shower space covered in Fenix; 8 mm tempered glass structure with polished aluminium edges  
Interior: sauna with furniture and cladding in abachi wood; shower area with Turkish bath clad in Fenix  
White glossy acrylic bath with MicroSilk® system  
2 faux leather anthracite finishing pillows

## FINITURA SAUNA \_ SAUNA FINISH

Interno ed arredamento  
Interior and furniture finishes



ABACHI  
Perline orizzontali  
Horizontal matchboard

## FINITURE HAMMAM \_ TURKISH BATH FINISHES

Interno ed esterno  
Interior and exterior



FENIX  
Grigio Efeso  
Grey Ephesus  
FENIX  
Grigio Bromo  
Grey Bromo

Misure disponibili / Available sizes



x 2/3 hammam  
x 3/4 sauna

395 x 150 x 215 h  
Hamмам 4 kW  
Sauna 4,5 kW  
Vasca 1,3 kW



x 2/3 hammam  
x 2/3 sauna

355 x 150 x 215 h  
Hamмам 4 kW  
Sauna 4,5 kW  
Vasca 1,3 kW

# Olimpo

Sistema combinato da due moduli:  
**Hamam (con doccia e vasca integrata)**

*System made up of two modules:*  
**Turkish bath (with shower and integrated bath)**

## DIMENSIONI

195x150x215 H Hamam  
 Potenza max:  
 Hamam 4 kW - Vasca 1,3 kW

## INSTALLAZIONE

Parete - Angolo - Nicchia

## CARATTERISTICHE

Basamento con piedini regolabili  
 Maniglie in alluminio  
 Pannello di controllo (bagno turco) touch screen in vetro serigrafato  
 Sistema audio con bluetooth  
 Cromoterapia diffusa a Led RGB con 3 cicli, cambio colore automatico e funzione iride a 42 colori  
 Spazio doccia con bagno turco e vasca con sistema MicroSilk®  
 Soffione in acciaio 30x30  
 Cascata  
 Rubinetteria termostatica con doccia  
 2 Cuscini coprivasca con funzione di seduta  
 Aspiratore  
 4 soffioni sequenziali posizionati sopra la vasca  
 Riempimento della vasca con ETP

## FINITURE

Esterno: spazio doccia rivestito in Fenix; cristallo temperato da 8 mm con profili in alluminio brillantato  
 Interno: spazio doccia con bagno turco rivestito in Fenix  
 Vasca in acrilico Bianco lucido con sistema MicroSilk®  
 2 cuscini in ecopelle Antracite

Misure disponibili / Available sizes



**x 2/3 hamam**  
 195 x 150 x 215 h  
 Hamam 4 kW  
 Vasca 1,3 kW

## MEASUREMENT

195x150x215 H Turkish bath  
 Max power:  
 Turkish bath 4 kW - Tub 1.3 kW

## INSTALLATION

Wall - Corner - Niche

## SPECIFICATIONS

Base with adjustable feet  
 Handles in aluminum  
 Screenprinted glass touch-screen display panel (turkish bath)  
 Audio system with bluetooth  
 RGB Led chromotherapy with 3 cycles, automatic colour change and 42-colour iris function  
 Shower area with Turkish bath and tub with MicroSilk®  
 Shower-head system in steel 30x30  
 Waterfall  
 Thermostatic tap with hand shower  
 2 folding pillows to cover the bathtub and to lie above or sit  
 Extractor fan  
 4 sequential head showers above the bathtub  
 Bathtub water filling through the overflow

## FINISHES

Exterior: shower space covered in Fenix; 8 mm tempered glass structure with polished aluminium edges  
 Interior: shower area with Turkish bath clad in Fenix  
 White glossy acrylic bath with MicroSilk® system  
 2 faux leather anthracite finishing pillows



Fenix Grigio Bromo  
 Fenix Grey Bromo



Fenix Grigio Efeso  
 Fenix Grey Efeso

## FINITURE HAMMAM \_ TURKISH BATH FINISHES

Interno ed esterno  
 Interior and exterior



FENIX  
 Grigio Efeso  
 Grey Ephesus

FENIX  
 Grigio Bromo  
 Grey Bromo

# ETHOS

design Franco Bertoli

Tre moduli per comporre un sistema di wellness integrato funzionale ed accogliente con hammam, spazio doccia e sauna fruibili contemporaneamente da una o più persone. Ethos crea la soluzione professionale ideale per piccole spa e strutture ricettive, ma anche per ogni tipo di ambiente domestico.

*Three modules to compose a functional and welcoming integrated wellness system with hammam, shower area and sauna that can be used simultaneously by one or more people. Ethos creates the ideal professional solution for small spas and accommodation facilities, but also for every type of home environment.*

**Liberi di scegliere tra 5 sistemi che combinano bagno turco, spazio doccia e sauna.**

*Free to choose among 5 systems combining turkish bath, shower and sauna.*



SAUNAVITA®  
calore naturale

# Ethos

collection

ETHOS | collection



**DIMENSIONI**  
400x150x215 H

**CARATTERISTICHE**  
hammam con doccia integrata +  
spazio doccia + sauna

**DIMENSIONS**  
400x150x215 H

**SPECIFICATIONS**  
hammam with integrated shower +  
shower + sauna

## Ethos

collection



### Legno Abachi

L'allestimento in legno crea un ambiente confortevole, con panche e poggiaschiena double-face.

### Abachi wood

The wooden fittings create a comfortable environment, with benches and double-face backrest.



### Apertura pivottante

La comoda apertura a bilico della porta in vetro trasparente o stop sol rende più agevole l'entrata.

### Pivoted opening

The convenient pivoted opening of the clear glass or Stopsol door makes entry more comfortable.



### Cromoterapia a led

Un sistema di cromoterapia a led permette di immergersi nella benefica influenza dei colori.

### Led colour therapy

A colour therapy system with LEDs lets you immerse yourself in the positive influence of colours.



### Ciotola in teak

Una fonte con l'originale ciotolina in teak per avere sempre a disposizione l'acqua fresca.

### Teak bowl

A fountain with original teak bowl so that cool water is always available.

# Ethos

collection



**DIMENSIONI**  
310x150x215 H

**CARATTERISTICHE**  
hammam con doccia integrata  
+ sauna

**DIMENSIONS**  
310x150x215 H

**SPECIFICATIONS**  
hammam with integrated shower  
+ sauna



# Ethos

collection

**DIMENSIONI**  
252x150x215 H

**CARATTERISTICHE**  
spazio doccia + sauna

**DIMENSIONS**  
252x150x215 H

**SPECIFICATIONS**  
shower + sauna

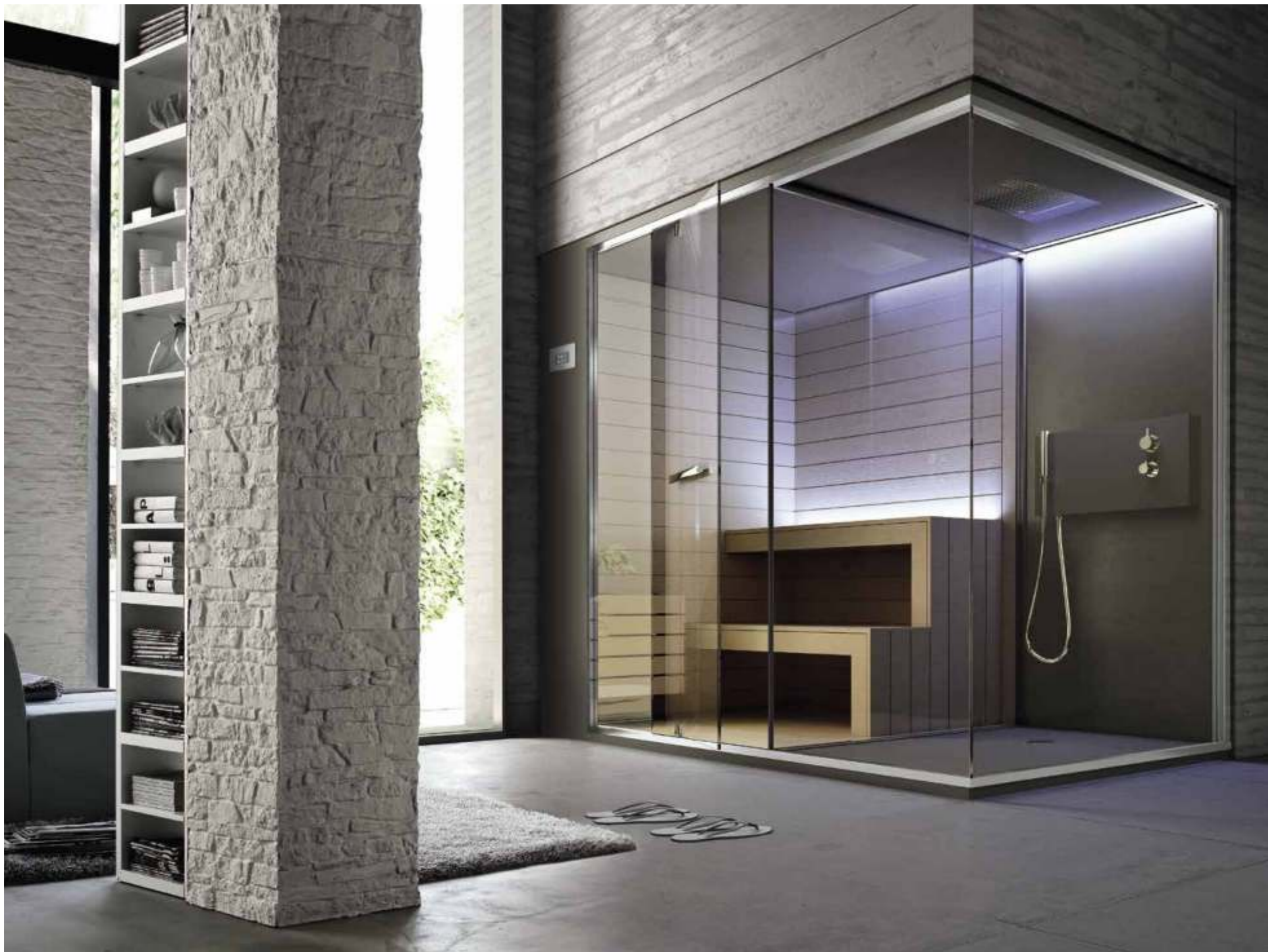

# Ethos

collection



**DIMENSIONI**  
242x150x215 H

**CARATTERISTICHE**  
hammam + spazio doccia

**DIMENSIONS**  
242x150x215 H

**SPECIFICATIONS**  
hammam + shower

# Ethos

## Finiture - Finishes

### Esterno

Porte e fissi in cristallo temperato 8 mm.  
Pannelli in laminato.

### Exterior

8 mm tempered glass doors and fixed panels.  
Laminate panels

### Interno

Sauna con arredamenti e rivestimenti in abachi.  
Hamam e spazio doccia rivestito con uno speciale laminato in finitura Grigio Cosmico.

### Interior

Sauna with abachi wood furnishes and coverings.  
Turkish bath and shower area covered with a special laminate Cosmico Grey finish.

### Piatto doccia

Piatto doccia in Solid Surface sp. 1,2 supportato da telaio in acciaio con piedini regolabili (sia nella doccia che nell'hammam).

### Shower tray

Solid surface shower tray, 1.2 thick, with steel frame and adjustable feet (both in the shower and the Turkish bath).

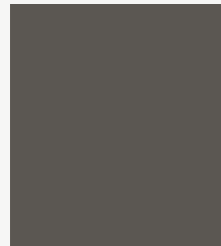

Grigio Cosmico

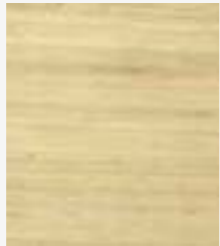

Sauna \_ Abachi

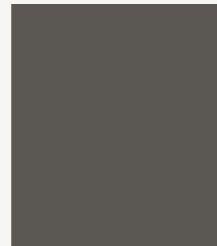

Hamam \_  
Grigio Cosmico



Solid Surface \_  
Grigio Cosmico

### DIMENSIONI

La modularità di Ethos consente di comporre il proprio ambiente wellness personalizzato  
400x150x215 H  
Potenza max:  
Hamam 4 kW - Sauna 4,5 kW

### INSTALLAZIONE

Parete - Angolo - Nicchia

### CARATTERISTICHE

Basamento con piedini regolabili  
Chiusure vetro temperato, spessore 8 mm  
Maniglie in alluminio / alluminio legno  
Mensola porta essenze  
Pannello di controllo (sia per sauna che hammam): pannello touch con finitura in vetro bianco  
Sistema audio con bluetooth

### MEASUREMENT

The modularity of Ethos lets you create your own wellness space  
400x150x215 H  
Max power:  
Turkish bath 4 kW - Sauna 4.5 kW

### INSTALLATION

Wall - Corner - Niche

### SPECIFICATIONS

Base with adjustable feet  
Tempered glass enclosures, 8 mm thick  
Handles in aluminum / aluminum wood  
Shelf  
Display panel (both for the sauna and the Turkish bath): touch screen panel with white glass finish  
Sound system with bluetooth



x 2/3 hammam  
x 2/3 sauna

400 x 150 x 215 h  
Hamam 4 kW  
Sauna 3,6 kW

### ACCESSORI SAUNA

Mestolo in legno  
Mastellino in legno  
Stufa con pietre  
Cromoterapia diffusa a Led RGB con 3 cicli, cambio colore automatico e funzione iride a 42 colori  
Poggiaschiena double-face

### ACCESSORI HAMMAM

Fonte con ciotolina in teak  
Erogatore di vapore  
Cromoterapia diffusa a Led RGB con 3 cicli, cambio colore automatico e funzione iride a 42 colori  
Soffione in acciaio 30x30  
Panca in laminato con cromoterapia integrata  
Rubinetteria termostatica con doccino

### ACCESSORIES SAUNA

Wooden ladle  
Wooden bucket  
Stove with stones  
RGB Led chromotherapy with 3 cycles, automatic colour change and 42-colour iris function  
Reversible backrest

### ACCESSORIES TURKISH BATH

Source with teak bowl  
Steam generator  
RGB Led chromotherapy with 3 cycles, automatic colour change and 42-colour iris function  
30x30 steel shower head  
Laminate bench with integrated chromotherapy  
Thermostatic taps with handheld shower head

### ACCESSORI SPAZIO DOCCIA

Soffione in acciaio 50x30 con cascata e nebulizzatore integrato  
Rubinetteria termostatica con doccino  
Cromoterapia diffusa a Led RGB con 3 cicli, cambio colore automatico e funzione iride a 42 colori posizionata nel tetto

### ACCESSORIES SHOWER AREA

50x30 steel shower head with waterfall feature and built-in atomiser  
Thermostatic taps with handheld shower head  
RGB Led chromotherapy with 3 cycles, automatic colour change and 42-colour iris function on the roof

# Ethos

**Hammam con doccia integrata + Sauna**  
*Turkish bath with integrated shower + Sauna*



x 2/3 hammam  
x 3/4 sauna  
350 x 150 x 215 h  
Hammam 4 kW  
Sauna 6 kW



x 2/3 hammam  
x 2/3 sauna  
310 x 150 x 215 h  
Hammam 4 kW  
Sauna 4,5 kW



x 3/4 sauna  
295 x 150 x 215 h  
Sauna 6 kW



x 2/3 sauna  
252 x 150 x 215 h  
Sauna 4,5 kW

## DIMENSIONI

La modularità di Ethos consente di comporre il proprio ambiente wellness personalizzato  
350x150x215 H  
Potenza max:  
Hammam 4 kW - Sauna 6 kW  
310x150x215 H  
Potenza max:  
Hammam 4 kW - Sauna 4,5 kW

## INSTALLAZIONE

Parete - Angolo - Nicchia

## CARATTERISTICHE

Basamento con piedini regolabili  
Chiusure vetro temperato, spessore 8 mm  
Maniglie in alluminio / alluminio legno  
Mensola porta essenze  
Pannello di controllo (sia per sauna che hammam): pannello touch con finitura in vetro bianco  
Sistema audio con bluetooth

## ACCESSORI SAUNA

Mestolo in legno  
Mastellino in legno  
Stufa con pietre  
Cromoterapia diffusa a Led RGB con 3 cicli, cambio colore automatico e funzione iride a 42 colori  
Poggiaschiene double-face

## ACCESSORI HAMMAM

Fonte con ciotolina in teak  
Erogatore di vapore  
Cromoterapia diffusa a Led RGB con 3 cicli, cambio colore automatico e funzione iride a 42 colori  
Soffione in acciaio 30x30  
Panca in laminato con cromoterapia integrata  
Rubinetteria termostatica con doccino

## DIMENSIONI

La modularità di Ethos consente di comporre il proprio ambiente wellness personalizzato  
295x150x215 H  
Potenza max: 6 kW  
252x150x215 H  
Potenza max: 4,5 kW

## INSTALLAZIONE

Parete - Angolo - Nicchia

## CARATTERISTICHE

Basamento con piedini regolabili  
Chiusure vetro temperato, spessore 8 mm  
Maniglie in alluminio / alluminio legno  
Pannello di controllo (sia per sauna che hammam): pannello touch con finitura in vetro bianco  
Sistema audio con bluetooth

## ACCESSORI SAUNA

Mestolo in legno  
Mastellino in legno  
Stufa con pietre  
Cromoterapia diffusa a Led RGB con 3 cicli, cambio colore automatico e funzione iride a 42 colori  
Poggiaschiene double-face

## ACCESSORI SPAZIO DOCCIA

Soffione in acciaio 50x30 con cascata e nebulizzatore integrato  
Rubinetteria termostatica con doccino  
Cromoterapia diffusa a Led RGB con 3 cicli, cambio colore automatico e funzione iride a 42 colori posizionata nel tetto

## MEASUREMENT

The modularity of Ethos lets you create your own wellness space  
350x150x215 H  
Max power:  
Turkish bath 4 kW - Sauna 6 kW  
310x150x215 H  
Max power:  
Turkish bath 4 kW - Sauna 4.5 kW

## INSTALLATION

Wall - Corner - Niche

## SPECIFICATIONS

Base with adjustable feet  
Tempered glass enclosures, 8 mm thick  
Handles in aluminum / aluminum wood  
Shelf  
Display panel (both for the sauna and the Turkish bath): touch screen panel with white glass finish  
Sound system with bluetooth

## ACCESSORIES SAUNA

Wooden ladle  
Wooden bucket  
Stove with stones  
RGB Led chromotherapy with 3 cycles, automatic colour change and 42-colour iris function  
Reversible backrest

## TURKISH BATH

Source with teak bowl  
Steam generator  
RGB Led chromotherapy with 3 cycles, automatic colour change and 42-colour iris function  
30x30 steel shower head  
Laminate bench with integrated chromotherapy  
Thermostatic taps with handheld shower head

## MEASUREMENT

The modularity of Ethos lets you create your own wellness space  
295x150x215 H  
Max power: 6 kW  
252x150x215 H  
Max power: 4.5 kW

## INSTALLATION

Wall - Corner - Niche

## SPECIFICATIONS

Base with adjustable feet  
Tempered glass enclosures, 8 mm thick  
Handles in aluminum / aluminum wood  
Display panel (both for the sauna and the Turkish bath): touch screen panel with white glass finish  
Sound system with bluetooth

## ACCESSORIES SAUNA

Wooden ladle  
Wooden bucket  
Stove with stones  
RGB Led chromotherapy with 3 cycles, automatic colour change and 42-colour iris function  
Reversible backrest

## ACCESSORIES SHOWER AREA

50x30 steel shower head with waterfall feature and built-in atomiser  
Thermostatic taps with handheld shower head  
RGB Led chromotherapy with 3 cycles, automatic colour change and 42-colour iris function on the roof

## Ethos

Hamam con doccia integrata + Spazio doccia  
*Turkish bath with integrated shower + Shower*



x 2/3 hammam

242 x 150 x 215 h  
 Hammam 4 kW

### DIMENSIONI

La modularità di Ethos consente di comporre il proprio ambiente wellness personalizzato  
 242x150x215 H  
 Potenza max: 4 kW

### INSTALLAZIONE

Parete - Angolo - Nicchia

### CARATTERISTICHE

Basamento con piedini regolabili  
 Chiusure vetro temperato, spessore 8 mm  
 Maniglie in alluminio  
 Mensola porta essenze  
 Pannello di controllo (hammam): pannello touch con finitura in vetro bianco  
 Sistema audio con bluetooth

### ACCESSORI HAMMAM

Fonte con ciotolina in teak  
 Erogatore di vapore  
 Cromoterapia diffusa a Led RGB con 3 cicli, cambio colore automatico e funzione iride a 42 colori  
 Soffione in acciaio 30x30  
 Panca in laminato con cromoterapia integrata  
 Rubinetteria termostatica con doccino

### ACCESSORI SPAZIO DOCCIA

Soffione in acciaio 50x30 con cascata e nebulizzatore integrato  
 Rubinetteria termostatica con doccino  
 Cromoterapia diffusa a Led RGB con 3 cicli, cambio colore automatico e funzione iride a 42 colori posizionata nel tetto

### MEASUREMENT

The modularity of Ethos lets you create your own wellness space  
 242x150x215 H  
 Max power: 4 kW

### INSTALLATION

Wall - Corner - Niche

### SPECIFICATIONS

Base with adjustable feet  
 Tempered glass enclosures, 8 mm thick  
 Handles in aluminum  
 Shelf  
 Display panel (Turkish Bath): touch screen panel with white glass finish  
 Sound system with bluetooth

### ACCESSORIES TURKISH BATH

Source with teak bowl  
 Steam generator  
 RGB Led chromotherapy with 3 cycles, automatic colour change and 42-colour iris function  
 30x30 steel shower head  
 Laminate bench with integrated chromotherapy  
 Thermostatic taps with handheld shower head

### ACCESSORIES SHOWER AREA

50x30 steel shower head with waterfall feature and built-in atomiser  
 Thermostatic taps with handheld shower head  
 RGB Led chromotherapy with 3 cycles, automatic colour change and 42-colour iris function on the roof

### DIMENSIONI

La modularità di Ethos consente di comporre il proprio ambiente wellness personalizzato  
 150x150x215 H  
 Potenza max: 4 kW

### INSTALLAZIONE

Parete - Angolo - Nicchia

Hamam con doccia integrata  
*Turkish bath with integrated shower*



x 2/3 hammam

150 x 150 x 215 h  
 Hammam 4 kW

### CARATTERISTICHE

Basamento con piedini regolabili  
 Chiusure vetro temperato, spessore 8 mm  
 Maniglie in alluminio  
 Mensola porta essenze  
 Pannello di controllo (hammam): pannello touch con finitura in vetro bianco  
 Sistema audio con bluetooth

### ACCESSORI HAMMAM

Fonte con ciotolina in teak  
 Erogatore di vapore  
 Cromoterapia diffusa a Led RGB con 3 cicli, cambio colore automatico e funzione iride a 42 colori  
 Soffione in acciaio 30x30  
 Panca in laminato con cromoterapia integrata  
 Rubinetteria termostatica con doccino

### MEASUREMENT

The modularity of Ethos lets you create your own wellness space  
 150x150x215 H  
 Max power: 4 kW

### INSTALLATION

Wall - Corner - Niche

### SPECIFICATIONS

Base with adjustable feet  
 Tempered glass enclosures, 8 mm thick  
 Handles in aluminum  
 Shelf  
 Display panel (Turkish Bath): touch screen panel with white glass finish  
 Sound system with bluetooth

### ACCESSORIES TURKISH BATH

Source with teak bowl  
 Steam generator  
 RGB Led chromotherapy with 3 cycles, automatic colour change and 42-colour iris function  
 30x30 steel shower head  
 Laminate bench with integrated chromotherapy  
 Thermostatic taps with handheld shower head

# ETHOS C ETHOS L

design Franco Bertoli

Legni pregiati, materiali tecnologicamente avanzati e soluzioni all'avanguardia che ridisegnano il ruolo della sauna e del bagno turco per gli ambienti domestici e professionali. Ethos C viene implementato con un modulo sauna affiancato dallo spazio doccia con bagno turco integrato.

*Precious woods, technologically advanced materials and cutting-edge solutions that revolutionize the role of the sauna and Turkish bath for domestic and professional settings. Ethos C is implemented with a sauna module with an integrated shower and Turkish bath.*

**Goditi la tua sauna con spazio doccia e bagno turco.**

*Enjoy your sauna with an integrated shower and Turkish bath area.*



# Ethos C

collection



**DIMENSIONI**  
252x120x215 H

**CARATTERISTICHE**  
sauna + spazio doccia con bagno turco

**DIMENSIONS**  
252x120x215 H

**SPECIFICATIONS**  
sauna + shower with steam generator

# Ethos C

collection



**DIMENSIONI**  
252x120x215 H (nicchia)

**CARATTERISTICHE**  
sauna + spazio doccia con  
bagno turco

**DIMENSIONS**  
252x120x215 H (niche)

**SPECIFICATIONS**  
sauna + shower with steam  
generator



## Ethos C - Ethos L

collection

Il rivestimento interno della sauna in Abachi e la cromoterapia trasmettono vibrazioni che riportano in equilibrio le energie.

*The internal coating of the sauna in Abachi and the chromotherapy instill vibrations that bring the energies back into balance.*



### Vano tecnico in Fenix

Da doccia a bagno turco: nel vano tecnico della caldaia sono integrati doccino e miscelatori.

### Technical box made by Fenix

*From shower to turkish bath: in the technical box is located the steam generator and the taps.*



### Maniglia in Abachi

La maniglia in Abachi è coordinata al rivestimento interno della sauna, per uno stile completo e armonioso.

### Abachi wood handles

*The Abachi wood handle matches the sauna's internal coating to make the entire setting as harmonious as ever.*



### Soffione

Un ampio soffione doccia con cascata a lama e getti nebulizzati crea un getto d'acqua avvolgente che rigenera la pelle dopo la sauna.

### Shower head

*A large shower head with water blade cascade and spray jets provides a water jet that embraces you and reinvigorates your skin after the sauna.*



**DIMENSIONI**  
252x120x215 H

**CARATTERISTICHE**  
spazio doccia + sauna

**DIMENSIONS**  
252x120x215 H

**SPECIFICATIONS**  
shower + sauna

## Ethos C

collection



L'area doccia in Fenix Grigio Bromo si abbina al vano tecnico e alle finiture esterne.

*The bromine grey Fenix shower area perfectly matches the technical compartment and external finishes.*

## Ethos C 200x100

collection



**GEROMIN**  
Comp. Change

**HAFRO**  
soluzioni per il piacere

Vasca - Tub Mode

**SAUNAVITA**  
calore naturale

Sauna Ethos C

**DIMENSIONI**  
200x100x215 H

**CARATTERISTICHE**  
sauna + spazio doccia  
con bagno turco

**DIMENSIONS**  
200x100x215 H

**SPECIFICATIONS**  
sauna + shower  
with steam generator

# Ethos L

collection



**DIMENSIONI**  
240x203x215 H

**CARATTERISTICHE**  
sauna + spazio doccia con  
bagno turco

**DIMENSIONS**  
240x203x215 H

**SPECIFICATIONS**  
sauna + shower with  
steam generator

## Ethos C - Ethos L

Sauna + Spazio doccia  
Sauna + Shower

Misure disponibili / Available sizes

### DIMENSIONI ETHOS C

295x120x215 H  
Sauna 200x120,  
doccia con bagno turco 95x120  
x2/3 persone  
(sauna 4,5 kW - bagno turco 2,5 kW)

252x120x215 H  
Sauna 160x120,  
doccia con bagno turco 92x120  
x2/3 persone  
(sauna 3,6 kW - bagno turco 2,5 kW)

200x100x215 H  
Sauna 115x100,  
doccia con bagno turco 85x100  
x2 persone  
(sauna 2,3 kW - bagno turco 2,5 kW)

### INSTALLAZIONE

Parete - Angolo - Nicchia

### ETHOS C MEASUREMENT

295x120x215 H  
Sauna 200x120,  
shower space with turkish bath 95x120  
x2/3 persons  
(sauna 4,5 kW - Turkish bath 2.5 kW)

252x120x215 H  
Sauna 160x120,  
shower space with turkish bath 95x120  
x2/3 persons  
(sauna 3,6 kW - turkish bath 2.5 kW)

200x100x215 H  
Sauna 115x100,  
shower space with turkish bath 85x100  
x2 persons  
(sauna 3 kW - turkish bath 2,5 kW)

### INSTALLATION

Wall - Corner - Niche

### DIMENSIONI ETHOS L (Angolo)

240x203x215 H  
Sauna 200x120,  
doccia con bagno turco 95x120  
x2/3 persone  
(sauna 4,5 kW - bagno turco 2,5 kW)

### CARATTERISTICHE

Basamento con piedini regolabili  
Chiusure vetro temperato, spessore 8 mm  
Pannello di controllo (sia per sauna che hammam): pannello touch con finitura in vetro bianco  
Sistema audio con bluetooth  
Mestolo in legno  
Mastellino in legno  
Stufa con pietre  
Cromoterapia diffusa a Led RGB con 3 cicli, cambio colore automatico e funzione iride a 42 colori  
Poggiaschiene double-face  
Sgabello acrilico trasparente 40x24,5x44 H  
Erogatore di vapore

### ETHOS L MEASUREMENT (Corner)

240x203x215 H  
Sauna 200x120,  
shower space with turkish bath 95x120  
x2/3 persons  
(sauna 4,5 kW - Turkish bath 2.5 kW)

### SPECIFICATIONS

Base with adjustable feet  
Tempered glass enclosures, 8 mm thick  
Display panel (both for the sauna and the Turkish bath): touch screen panel with white glass finish  
Sound system with bluetooth  
Wooden ladle  
Wooden bucket  
Stove with stones  
RGB Led chromotherapy with 3 cycles, automatic colour change and 42-colour iris function  
Reversible backrest  
Transparent acrylic stool 40x24.5x44 H  
Steam generator

### ACCESSORI

Poggiaschiene double-face (oltre a quello in dotazione)  
Fianco di tamponamento per installazione ad angolo

### FINITURE

Esterno pareti e porte in cristallo temperato da 8 mm  
Interno con arredamenti e rivestimenti in abachi  
Maniglie in alluminio / alluminio legno  
Pannelli in laminato Fenix: Alaska - Bianco Kos - Grigio Bromo - Grigio Londra - Grigio Efeso

### ACCESSORIES

Double face back rest (in addition to the supplied one)  
Insulation panel for corner installation

### FINISHING

Tempered glass exterior walls and doors from 8 mm  
Interior with abachi wood furnishes and coverings  
Handles in aluminum / aluminum wood  
Laminate panel Fenix: Alaska - White Kos - Gray Bromo - Gray London - Gray Ephesus

### FINITURE FENIX \_ FENIX FINISHES

Esterno ed interno spazio doccia  
Exterior and interior shower

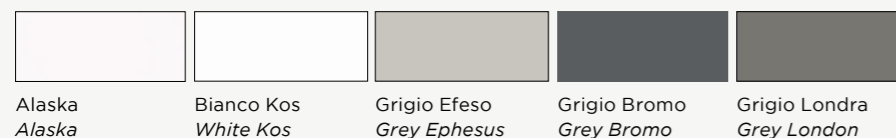

Alaska  
Alaska

Bianco Kos  
White Kos

Grigio Efeso  
Grey Ephesus

Grigio Bromo  
Grey Bromo

Grigio Londra  
Grey London

Vano tecnico  
in finitura Grigio Londra  
Technical compartment  
in London grey finishing

Vano tecnico  
della stessa finitura  
Technical compartment  
of the same finish

### FINITURA SAUNA \_ SAUNA FINISH

Interno ed arredamento  
Interior and furniture finishes



ABACHI  
Perline orizzontali  
Horizontal matchboard

### Ethos C



x 2/3

295 x 120 x 215 h  
Sauna 200 x 120 / 4,5 kW  
Doccia + Hammam 95 x 120 / 2,5 kW

### Ethos C



x 2/3

252 x 120 x 215 h  
Sauna 157 x 120 / 3,6 kW  
Doccia + Hammam 95 x 120 / 2,5 kW

### Ethos C



x 2

200 x 100 x 215 h  
Sauna 115 x 100 / 3 kW  
Doccia + Hammam 85 x 100 / 2,5 kW

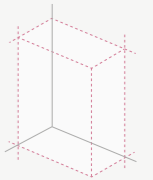

Optional  
**Misure personalizzate**  
Custom-made

### Ethos L



x 2/3

240 x 203 x 215 h  
Sauna 200 x 120 / 4,5 kW  
Doccia + Hammam 95 x 120 / 2,5 kW

# CONSIGLI PER LA SAUNA

## Sauna tips



All'interno della sauna si crea un ambiente molto caldo e secco che stimola la sudorazione e l'espulsione delle tossine. Per godere a pieno delle proprietà rilassanti, depurative e rivitalizzanti della sauna, occorre prendersi un po'di tempo e seguire alcuni semplici ma importantissimi passaggi.

*The hot and dry environment inside a sauna stimulates transpiration and the elimination of toxins. To fully enjoy the relaxing, purifying, and revitalising properties of a sauna, you need to take your time and follow a few simple but very important steps.*



Prima della sauna fai una doccia tiepida per rilassare i muscoli e preparare la pelle dilatando i pori. Poi asciugati e togli tutto ciò che può riscaldarsi e scottarti.

*Take a warm shower before a sauna to relax your muscles and prepare your skin by opening pores. Dry yourself up and remove everything that can heat up and burn you.*

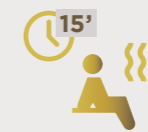

Una volta entrato siediti o distenditi sul livello più basso e meno caldo. La permanenza in sauna a una temperatura di 90°-95° C potrà durare dai 10 ai 15 minuti.

*Once in, sit down or lie down at the lowest bench level, which is also the least hot. You can stay in a sauna at a temperature ranging from 90° to 95° C for 10 to 15 minutes.*



Esci lentamente dalla sauna e fai una doccia o un'immersione fredda: lo sbalzo termico richiude i pori della pelle e stimola la circolazione allenando i vasi sanguigni.

*Slowly get out of the sauna and take a cold shower or a cold immersion to close the pores again and stimulate blood circulation.*



Stenditi su un lettino reclinato e rilassati. Durante la sauna hai perso molti liquidi con la sudorazione, perciò reidratati bevendo dell'acqua.

*Lie down on a recliner and relax. You lose plenty of fluids with transpiration, so make sure to drink a lot of water.*



Puoi ripetere l'intero ciclo fino a tre volte. Se te la senti, puoi aumentare gradualmente la temperatura a cui sottoponi il corpo sedendoti sui livelli più alti della sauna.

*You can repeat the entire cycle up to three times. If you feel like it, you can gradually increase the temperature by sitting at a higher bench level.*

# GHIBLI SAUNA

design Franco Bertoli

Una gamma che cresce per essere sempre più versatile,  
per dare più libertà di scelta e soluzioni per ogni esigenza.

*A collection that grows to be more and more versatile,  
to give freedom of choice and solutions for every need.*

**Entra nel caldo abbraccio  
di una stupenda sauna.**

*Enter in the warm  
embrace of a wonderful sauna.*

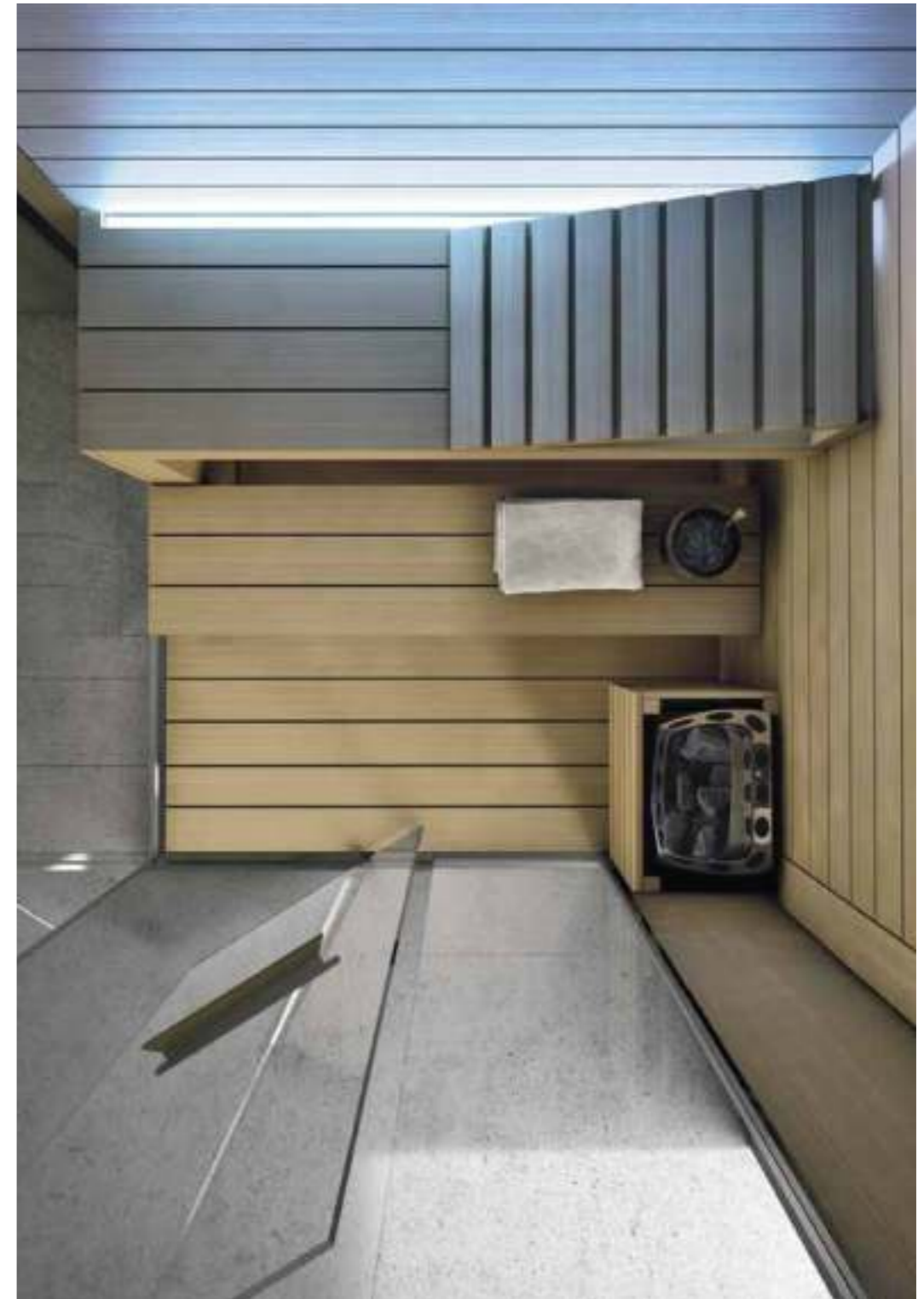

SAUNAVITA®  
calore naturale

## Ghibli sauna

collection



**DIMENSIONI**  
150x150x215 H

**CARATTERISTICHE**  
sauna

**DIMENSIONS**  
150x150x215 H

**SPECIFICATIONS**  
sauna





**Ghibli sauna**  
collection

**DIMENSIONI**  
200x150x215 H

**CARATTERISTICHE**  
sauna

**DIMENSIONS**  
200x150x215 H

**SPECIFICATIONS**  
sauna

# Ghibli

## Sauna

### DIMENSIONI

Sauna 200x150x215 H - x3/4 persone  
Potenza max: 6 kW

Sauna 200x120x215 H - x3/4 persone  
Potenza max: 6 kW

Sauna 150x150x215 H - x2/3 persone  
Potenza max: 4,5 kW

Sauna 150x120x215 H - x2/3 persone  
Potenza max: 4,5 kW

### Realizzazioni anche su misura

### INSTALLAZIONE

Parete - Angolo - Nicchia

### CARATTERISTICHE

Basamento con piedini regolabili  
Chiusure vetro temperato, spessore 8 mm

Pannello di controllo: pannello touch  
con finitura in vetro bianco

Sistema audio con buetooth

Mestolo in legno

Mastellino in legno

Stufa con pietre

Cromoterapia diffusa a Led RGB  
con 3 cicli, cambio colore automatico  
e funzione iride a 42 colori

Poggiaschiena double-face

### FINITURE

Esterno: porta con cerniere pivotanti  
e fissi in cristallo temperato da 8 mm

Profili: in alluminio finitura Brill

Interno con arredamenti e rivestimenti  
in abachi

Parete sp. 6 cm coibentata con  
lana di roccia

### MEASUREMENT

Sauna 200x150x215 H - x3/4 persons  
Max power: 6 kW

Sauna 200x120x215 H - x3/4 persons  
Max power: 6 kW

Sauna 150x150x215 H - x2/3 persons  
Max power: 4,5 kW

Sauna 150x120x215 H - x2/3 persons  
Max power: 4,5 kW

### Can be custom-made

### INSTALLATION

Wall - Corner - Niche

### SPECIFICATIONS

Base with adjustable feet

Tempered glass enclosures, 8 mm thick

Display panel: touch screen panel  
with white glass finish

Sound system with bluetooth

Wooden ladle

Wooden bucket

Stove with stones

RGB Led chromotherapy with 3 cycles,  
automatic colour change and 42-colour  
iris function

Reversible backrest

### FINISHING

Exterior: 8 mm tempered glass door  
with pivot hinges and fixed panels

Profiles: Brill finish aluminium

Interior with abachi wood furnishes  
and coverings

Rockwool insulated wall, 6 cm thick

### FINITURE FENIX \_ FENIX FINISHES

Esterno  
Exterior



Alaska  
Alaska

Bianco Kos  
White Kos

Grigio Efeso  
Grey Ephesus

Grigio Bromo  
Grey Bromo

Grigio Londra  
Grey London

### FINITURA SAUNA \_ SAUNA FINISH

Interno ed arredamento  
Interior and furniture finishes



ABACHI  
Perline orizzontali  
Horizontal matchboard

Misure disponibili / Available sizes

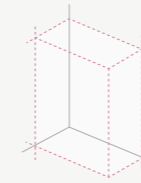

Optional

### Misure personalizzate

Custom-made



Installazione a parete con fianco a vista in finitura legno Abachi.

Wall installation with visible side in Abachi wood finish.

Interno e arredamento in legno ABACHI  
Interior and furniture in wood Abachi finish

FENIX  
Alaska - Bianco Kos - Grigio Bromo - Grigio Londra - Grigio Efeso

Parete laterale in finitura legno ABACHI  
Side wall in wood Abachi finish

# GHIBLI HAMMAM

design Franco Bertoli

Ghibli è un modello di hammam e doccia "chiavi in mano" completo di generatore e struttura coibentante, subito pronto all'uso. Ghibli semplifica ogni cosa: niente interventi in muratura, niente allestimenti complessi, tempi di attesa e più figure professionali da coordinare. Ghibli viene realizzato in tre dimensioni pensate per accogliere una o più persone: le tre misure ne facilitano l'inserimento in ogni tipologia di ambiente per soddisfare al meglio le esigenze di spazio, mantenendo inalterate le qualità tecniche ed estetiche.

*Ghibli is a model of hammam and shower complete with steam generator and insulating structure, immediately ready for use. Ghibli simplifies everything: no masonry works, no complex set-ups, waiting times and professional figures to coordinate. Designed to accommodate one or more persons, Ghibli is available in three sizes that facilitate its insertion in any type of environment to best meet space requirements, while maintaining technical and aesthetic qualities.*

**Ecco l'Hamмам con doccia  
subito pronto, a casa tua!**

*The Turkish Hammam with shower ready for use,  
at your home!*



# Ghibli hammam

collection



**DIMENSIONI**  
150x150x215 H

**CARATTERISTICHE**  
bagno turco

**DIMENSIONS**  
150x150x215 H

**SPECIFICATIONS**  
turkish bath



## Ghibli hammam

*collection*



### **Panca con cromoterapia**

La luce integrata nella seduta diffonde in tutto l'ambiente sauna i benefici della cromoterapia.

### ***Bench with chromotherapy***

*The light integrated in the seat spreads the benefits of chromotherapy all over the sauna.*



### **Maniglia**

La maniglia orizzontale applicata consente una comoda apertura e la finitura è coordinata al profilo.

### ***Handle***

*The horizontal handle allows for easy opening and the finish matches the profile.*

## Ghibli hammam

collection



**DIMENSIONI**  
150x90x215 H

**CARATTERISTICHE**  
bagno turco

**DIMENSIONS**  
150x90x215 H

**SPECIFICATIONS**  
turkish bath

# Ghibli

## Hammam

### DIMENSIONI

150x150x215 H - x3/4 persone  
Potenza max: 4,1 kW  
150x120x215 H - x2/3 persone  
Potenza max: 3,1 kW  
150x90x215 H - x1 persona  
Potenza max: 3,1 kW

### INSTALLAZIONE

Angolo

### CARATTERISTICHE

Struttura basamento con piedini regolabili  
Chiusure vetro temperato, spessore 8 mm  
Pannello di controllo: pannello touch con finitura in vetro bianco  
Sistema audio con bluetooth  
Fonte con ciotolina in Solid Surface  
Erogatore di vapore  
Cromoterapia diffusa a Led RGB con 3 cicli, cambio colore automatico e funzione iride a 42 colori integrata su tetto e panca  
Soffione in acciaio 30x30  
Miscelatore termostatico con doccino  
Mensola porta essenze / porta occhiali in Solid Surface e acciaio

### FINITURE

Esterno ed interno in Solid Surface  
Maniglia alluminio Brill  
Pareti coibentate in poliuretano  
Profili alluminio Brillantato  
Piatto in Solid Surface

### MEASUREMENT

150x150x215 H - x3/4 persons  
Max power: 4.1 kW  
150x120x215 H - x2/3 persons  
Max power: 3.1 kW  
150x90x215 H - x1 person  
Max power: 3.1 kW

### INSTALLATION

Corner

### SPECIFICATIONS

Base with adjustable feet  
Tempered glass enclosures, 8 mm thick  
Control panel: touch screen panel with white glass finish  
Sound system with bluetooth  
Source with Solid Surface bowl  
Steam generator  
RGB Led chromotherapy with 3 cycles, automatic colour change and 42-colour iris function integrated on the roof and bench  
30x30 steel shower head  
Thermostatic mixer with handheld shower head  
Solid surface and steel essence / glasses shelf

### FINISHING

Solid surface exterior and interior  
Brill finish aluminium handle  
Polyurethane insulated walls  
Brill finish aluminium profiles  
Solid surface tray

Misure disponibili / Available sizes



x 3/4

150 x 150 x 215 h  
Potenza max 4,1 kW



x 2/3

150 x 120 x 215 h  
Potenza max 3,1 kW



x 1

150 x 90 x 215 h  
Potenza max 3,1 kW

### FINITURA BAGNO TURCO \_ TIRKISH BATH FINISH

Esterno e interno  
Exterior and interior

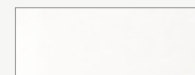

SOLID SURFACE

# KALIKA

design Stefano Tondato

Le pareti a tutta altezza in cristallo temperato danno forma a una sauna luminosa, alleggerita dai punti luce a led posizionati sopra le sedute. Le panche sospese, la stufa in acciaio e la tastiera digitale uniscono il design alla funzionalità.

*The full-height tempered glass walls give shape to a bright sauna, lightened by the LED spotlights positioned above the seats. The suspended benches, the steel stove and the digital display panel combines design and functionality.*

**La sauna finlandese che  
combina l'eleganza del vetro con  
la tradizione del legno.**

*The Finnish sauna that combines  
the elegance of glass with  
the tradition of wood.*





# Kalika

collection

La luminosa Kalika, con le sue pareti di cristallo da 8 mm a tutta altezza, si trasforma nella sauna perfetta. Alla gamma delle misure standard si aggiunge la possibilità di personalizzare gli ingombri in base agli spazi a disposizione. Tutti gli elementi funzionali della sauna - sedute, panche sospese, stufa - possono essere riconfigurati nella posizione preferita. Perfetta anche nei materiali, da scegliere in base al proprio stile.

*What makes Kalika so bright are the 8 mm crystal walls that develop in height. The sauna has never been so perfect! Perfect dimensions: in addition to standard sizes, we give you the opportunity to customise the overall dimensions based on the available space. Perfect composition: all the functional elements of the sauna - chairs, suspended benches, and stove - can be configured in the position you prefer. Perfect materials: to be chosen based on your style.*

**DIMENSIONI**  
360x130x214 H

**CARATTERISTICHE**  
sauna

**DIMENSIONS**  
360x130x214 H

**SPECIFICATIONS**  
sauna



# Kalika

collection



**DIMENSIONI**  
180x180x215 H

**CARATTERISTICHE**  
sauna

**DIMENSIONS**  
180x180x215 H

**SPECIFICATIONS**  
sauna



Stufa compatta in acciaio con pietre laviche  
incluse, non richiede protezioni.

*Compact steel stove with lava stones included.  
It does not need any protection.*



3,5-4,5-  
6-7,5 kW



3-8,5 m<sup>3</sup>

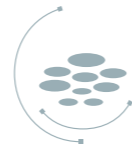

15 kg



**Sensore di temperatura**  
*Temperature sensor*



**Camino per aerazione**  
*Ventilation grid*





## Kalika

collection



La pedana in legno grigliato, posata sul pavimento, rende confortevole l'ingresso nella sauna.

*The wooden slatted footrest will make your sauna experience more comfortable.*



Le panche sospese, pensate per l'ergonomia del corpo, sono state alleggerite grazie ad un lavoro di design che le ha rese più funzionali ed accoglienti.

*Suspended benches have been designed in harmony with body ergonomics, lightened by an even more functional and welcoming design.*



**Kalika**  
collection

**DIMENSIONI**  
160x160x215 H

**CARATTERISTICHE**  
sauna

**DIMENSIONS**  
160x160x215 H

**SPECIFICATIONS**  
sauna



## Kalika

collection



Il pannello di controllo touch permette di regolare la temperatura della sauna e di controllarne tutte le funzioni.

*The touch display panel allows you to adjust the sauna temperature and control all the functions.*

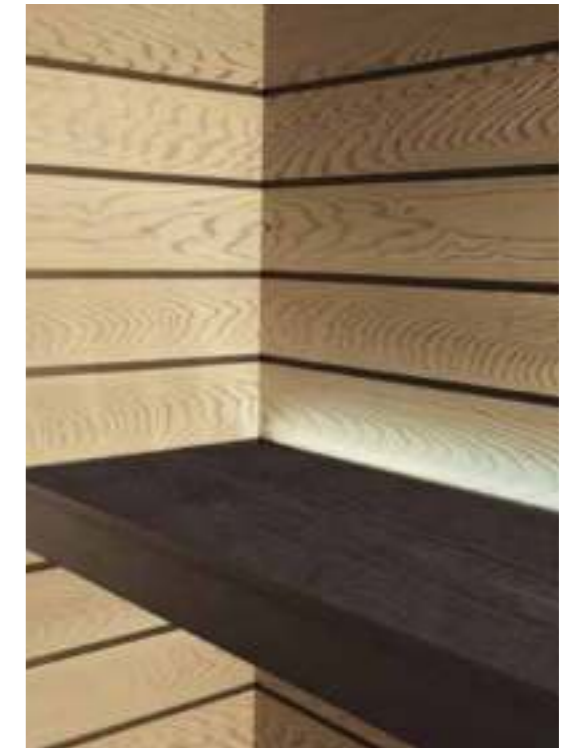

Le fonti luminose a Led posizionate lungo le panche creano nell'ambiente un'atmosfera rilassante.

*Led light sources positioned along the benches create a relaxing atmosphere in the environment.*

# Kalika

collection

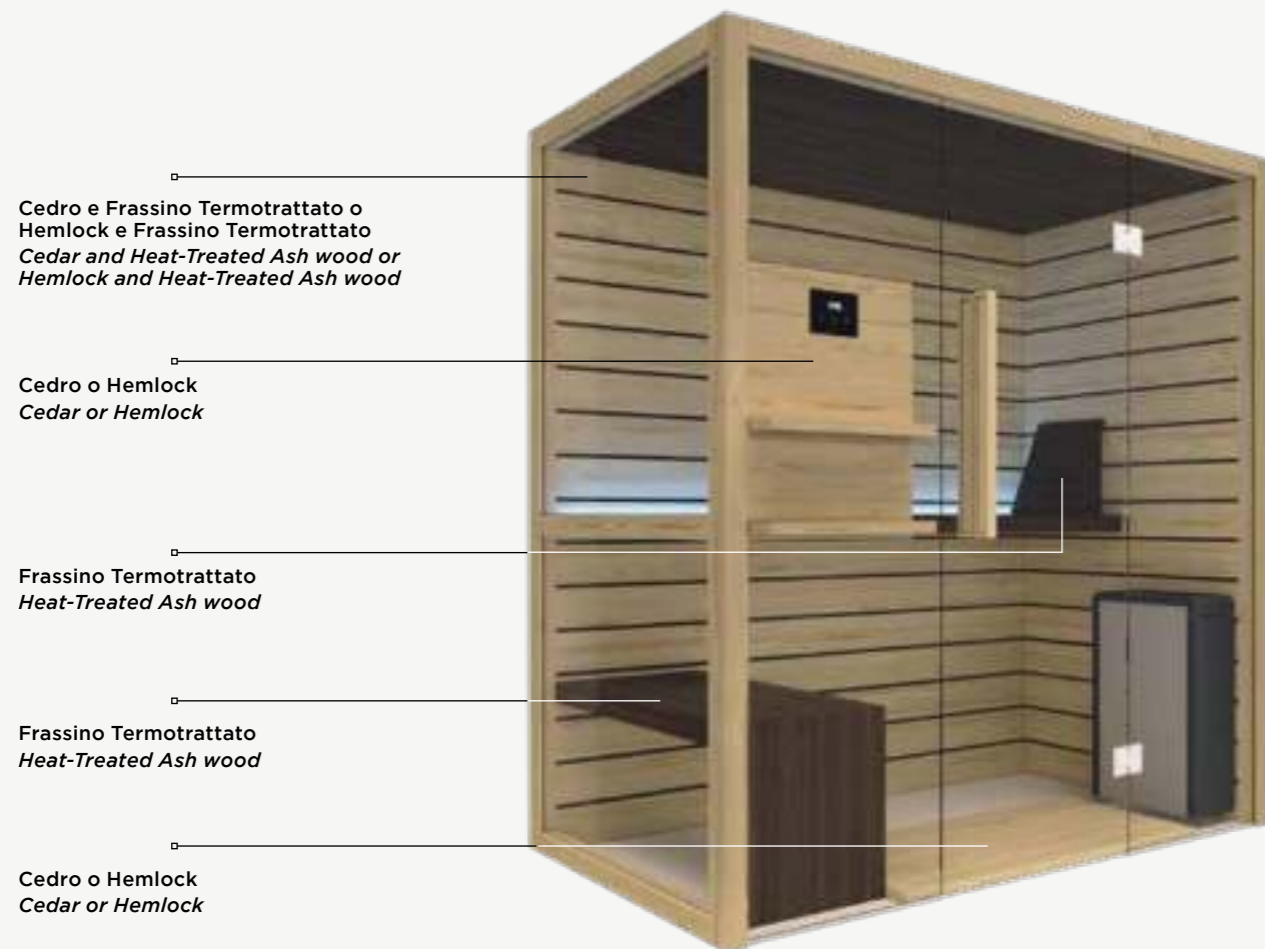

**Cedro + Frassino Termotrattato**  
*Cedar + Heat-Treated Ash wood*



H perline Cedro: 13,5 cm  
 H perline Frassino Termotrattato: 1,5 cm  
*Cedar matchboard height: 13.5 cm  
 Heat-treated Ash matchboard H: 1.5 cm*

**Hemlock + Frassino Termotrattato**  
*Hemlock + Heat-Treated Ash wood*



H perline Hemlock: 11,5 cm  
 H perline Frassino Termotrattato: 1,5 cm  
*Hemlock matchboard height: 11.5 cm  
 Heat-treated Ash matchboard H: 1.5 cm*

**Angolo / Parete** (versione DX)  
*Corner / Wall (RH version)*



**Nicchia / Parete / Angolo** (versione DX)  
*Niche / Wall / Corner (RH version)*



# Kalika

## Sauna

### DIMENSIONI

Sauna 160x120x215 H - x1/2 persone  
Potenza max: 3,5 kW  
Sauna 180x120x215 H - x2/3 persone  
Potenza max: 3,5 kW  
Sauna 200x120x215 H - x3 persone  
Potenza max: 4,5 kW  
Sauna 160x160x215 H - x3 persone  
Potenza max: 4,5 kW  
Sauna 180x160x215 H - x3/4 persone  
Potenza max: 6,0 kW  
Sauna 180x180x215 H - x4/5 persone  
Potenza max: 6,0 kW  
Sauna 180x200x215 H - x5 persone  
Potenza max: 7,5 kW  
Sauna 200x160x215 H - x4 persone  
Potenza max: 6,0 kW  
Sauna 200x180x215 H - x5 persone  
Potenza max: 7,5 kW  
Sauna 200x200x215 H - x5/6 persone  
Potenza max: 7,5 kW

Realizzazioni anche su misura

### MEASUREMENT

Sauna 160x120x215 H - x1/2 persons  
Max power: 3.5 kW  
Sauna 180x120x215 H - x2/3 persons  
Max power: 3.5 kW  
Sauna 200x120x215 H - x3 persons  
Max power: 4.5 kW  
Sauna 160x160x215 H - x3 persons  
Max power: 4.5 kW  
Sauna 180x160x215 H - x3/4 persons  
Max power: 6.0 kW  
Sauna 180x180x215 H - x4/5 persons  
Max power: 6.0 kW  
Sauna 180x200x215 H - x5 persons  
Max power: 7.5 kW  
Sauna 200x160x215 H - x4 persons  
Max power: 6.0 kW  
Sauna 200x180x215 H - x5 persons  
Max power: 7.5 kW  
Sauna 200x200x215 H - x5/6 persons  
Max power: 7.5 kW

Can be custom-made

### CARATTERISTICHE

Basamento con piedini regolabili  
Chiusure vetro temperato, spessore 8 mm  
Pannello di controllo: touch  
Sistema audio: 2 casse stereo ausiliarie con Bluetooth  
Mestolo in legno  
Mastellino in legno  
Stufa compatta in acciaio con pietre laviche incluse  
Cromoterapia diffusa a Led RGB con 3 cicli, cambio colore automatico e funzione iride a 42 colori  
Poggiaschiena double-face  
Porta battente e fissi in cristallo temperato da 8 mm  
Parete sp. 6 cm coibentata con lana di roccia

### INSTALLAZIONE

Parete - Angolo - Nicchia

### SPECIFICATIONS

Base with adjustable feet  
Tempered glass enclosures, 8 mm thick  
Display panel: touch  
Sound system: 2 auxiliary stereo speakers with Bluetooth  
Wooden ladle  
Wooden bucket  
Compact steel stove with stones included.  
RGB LED chromotherapy with 3 cycles, automatic colour change and 42-colour iris function  
Reversible backrest  
8 mm tempered glass hinged and fixed door  
Rockwool insulated wall, 6 cm thick

### INSTALLATION

Wall - Corner - Niche

### FINITURE

Esterno: struttura in Cedro o Helmock  
Interno: doghe in Cedro + Frassino termotrattato o Hemlock + Frassino termotrattato  
Panche e tetto in Frassino termotrattato

### FINISHING

Exterior: Cedar or Helmock structure  
Interior: Cedar slats + Heat-treated ash wood or Hemlock + heat-treated ash wood  
Benches and roof made of heat-treated ash wood

### FINITURE SAUNA \_ SAUNA FINISHES

#### Esterno Exterior



CEDRO HEMLOCK

#### Interno Interior

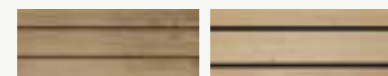

CEDRO +  
FRASSINO  
TERMOTRATTATO HEMLOCK +  
FRASSINO  
TERMOTRATTATO

#### Arredamento Furniture



FRASSINO  
TERMOTRATTATO HEMLOCK  
Panche, tetto  
e sedute sospese.  
Benches, roof and  
suspended seats.

Misure disponibili / Available sizes



x 1/2  
160 x 120 x 215 h  
Sauna 3,5 kW



x 2/3  
180 x 120 x 215 h  
Sauna 3,5 kW



x 3  
200 x 120 x 215 h  
Sauna 4,5 kW



x 3  
160 x 160 x 215 h  
Sauna 4,5 kW  
Biosauna 5,5 kW\*



x 3/4  
180 x 160 x 215 h  
Sauna 6 kW  
Biosauna 7 kW\*



x 4  
200 x 160 x 215 h  
Sauna 6 kW  
Biosauna 7 kW\*



x 4/5  
180 x 180 x 215 h  
Sauna 6,0 kW  
Biosauna 7 kW\*



x 5  
200 x 180 x 215 h  
Sauna 7,5 kW  
Biosauna 9 kW\*

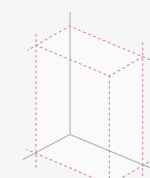

Optional  
**Misure personalizzate**  
Custom-made



x 5  
180 x 200 x 215 h  
Sauna 7,5 kW  
Biosauna 9 kW\*



x 5/6  
200 x 200 x 215 h  
Sauna 7,5 kW  
Biosauna 9 kW\*

\* potenza massima - max power



# CUNA DOCCIA

design Franco Bertoli

Sauna e doccia unite in una pratica combinazione, facilmente inseribile in ogni spazio, per godere dell'antico rito di fuoco e acqua.

*Sauna and shower combined in a practical combination, which can be easily adapted to any space, to enjoy the ancient ritual of fire and water.*

**Sauna e doccia vivono insieme anche in piccoli spazi.**

*Sauna and shower can live together also in a little space.*



SAUNAVITA®  
calore naturale

## Cuna doccia

collection



**DIMENSIONI**  
205x172x204 H

**CARATTERISTICHE**  
sauna + doccia

**DIMENSIONS**  
205x172x204 H

**SPECIFICATIONS**  
sauna + shower

## Cuna doccia

*collection*

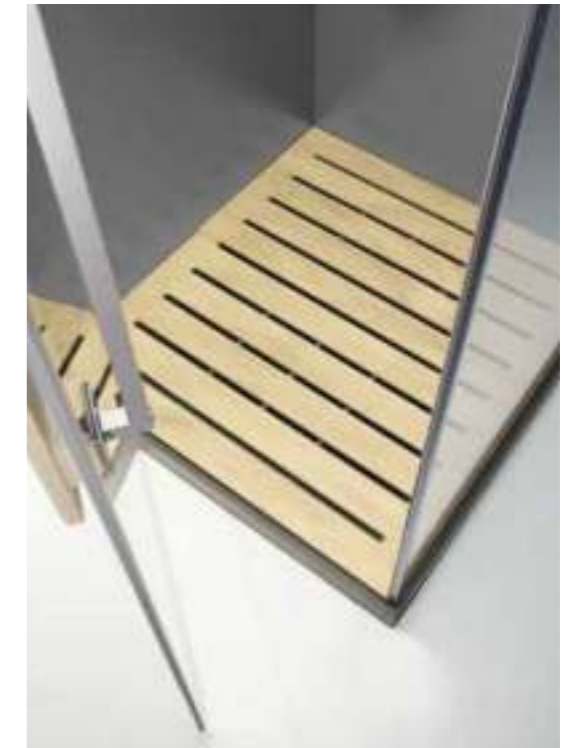

Alla cabina doccia si accede mediante una porta con apertura pivotante e maniglia in legno uguale a quella della sauna.

*Enter the shower unit via a pivot door featuring a wooden handle match the sauna handle.*

Box con soffione integrato, rubinetteria termostatica, doccetta, 4 jets verticali e pedana in multistrato marino.

*Shower Cabin with integrated hot spray, thermostatic taps, shower head, 4 vertical jets and platform in marine plywood.*

## Cuna doccia

Sauna + Spazio doccia  
Sauna + Shower space

### DIMENSIONI

205x207x204 H - x3/4 persone  
Potenza max: 3,6 kW

205x172x204 H - x2/3 persone  
Potenza max: 3 kW

200x92x204 H - x1 persona  
Potenza max: 2,3 kW

### Realizzazioni anche su misura

### INSTALLAZIONE

Parete - Angolo

### MEASUREMENT

205x207x204 H - x3/4 persons  
Max power: 3.6 kW

205x172x204 H - x2/3 persons  
Max power: 3 kW

200x92x204 H - x1 person  
Max power: 2.3 kW

### Can be custom-made

### INSTALLATION

Wall - Corner

### CARATTERISTICHE SAUNA

Mestolo in legno

Mastellino in legno

Mensola porta essenze / porta occhiali

Porta salviette

Struttura basamento con piedini regolabili

Cromoterapia diffusa a Led RGB con 3 cicli, cambio colore automatico e funzione iride da 42 colori

Porta vetro temperato, spessore 8 mm

Stufa con pietre

Pannello interno con lastra di protezione ultrapiatta Laminam® (finitura bronzo) posizionata dietro la stufa

Pannello di controllo: pannello touch con finitura in vetro bianco

Di serie: 2 poggiatesta double-face

### SPECIFICATIONS SAUNA

Wooden ladle

Wooden bucket

Essence/glasses shelf

Towel holder

Base with adjustable feet

RGB Led chromotherapy with 3 cycles, automatic colour change and 42-colour iris function

Tempered glass door, 8 mm thick

Stove with stones

Interior panel with super-flat Laminam® protection plate (bronze finish) placed behind the stove

Display panel: touch screen panel with white glass finish

2 standard reversible backrests

### CARATTERISTICHE CABINA DOCCIA

Piatto doccia

Pareti attrezzate con rubinetteria termostatica e 4 soffioni verticali

Doccetta

Chiusura con porta battente in cristallo da 8 mm

Pedana in legno multistrato marino

Soffione

### ACCESSORI SAUNA

Poggiaschiene double-face abachi

Sistema audio con bluetooth

### FINITURE

Esterno: hemlock / hemlock e pannello frontale in wenge

Interno: hemlock

Arredamenti: abachi

### SPECIFICATIONS SHOWER CABIN

Shower tray

Walls with thermostatic taps and 4 vertical jets

Handheld shower head

8 mm safety glass enclosure with hinged door

Marine plywood footboard

Fixed head shower

### ACCESSORIES SAUNA

Abachi wood reversible backrest

Sound system with bluetooth

### FINISHES

Exterior: hemlock / hemlock and wenge front panel

Interior: hemlock

Furnitures: abachi wood

### FINITURE LEGNO SAUNA \_ SAUNA WOOD FINISHES

Esterno  
Exterior



HEMLOCK

Interno  
Interior

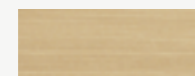

HEMLOCK  
Perline orizzontali  
Horizontal matchboards

Arredamento  
Furniture

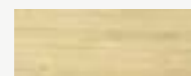

ABACHI

### SPAZIO DOCCIA \_ SHOWER SPACE

Piatto doccia  
Shower tray



SOLID SURFACE  
Grigio Cosmico

Doccia  
Shower



GRIGIO COSMICO

Misure disponibili / Available sizes

### Parete Wall



x 1

200 x 92 x 204 h

Potenza max 2,3 kW

### Angolo Corner



x 3/4

205 x 207 x 204 h

Potenza max 3,6 kW



x 2/3

205 x 172 x 204 h

Potenza max 2,3 kW

# CUNA

design Franco Bertoli

Una sauna finlandese che unisce bellezza estetica e massima funzionalità. Disponibile in vari modelli e dimensioni, per adattarsi a tutti gli spazi, Cuna permette di godere dei benefici del calore attraverso un sistema tecnologico avanzato e materiali ricercati.

*A Finnish sauna that combines beauty and functionality. Cuna is available in various models and sizes to adapt to any space and allows you to enjoy all the benefits of heat through an advanced technological system and refined materials.*

**Il giusto equilibrio tra legno  
eco-trattato e vetro di altissima qualità.**

*The perfect balance between eco-treated  
wood and top-quality glass.*



## Cuna 165 V

collection



**DIMENSIONI**  
165x127x204 H

**CARATTERISTICHE**  
doppia porta - x2/3 persone  
potenza max 3 kW

**DIMENSIONS**  
165x127x204 H

**SPECIFICATIONS**  
double door - x2/3 persons  
max power 3 kW

## Cuna

collection



L'installazione di un sistema di cromoterapia a Led permette di immergersi nei colori e nella loro benefica influenza per stimolare gioia, energia e per godersi un momento di puro relax.

*The installation of a LED chromotherapy system allows you to immerse yourself in colours and their beneficial influence to stimulate joy, energy and to enjoy a moment of pure relaxation.*



La musica si diffonde nella sauna grazie a un sistema audio con bluetooth da collegare allo smartphone.

*The music spreads in the sauna thanks to an audio system with bluetooth to connect to the smartphone.*



La stufa, centro naturale della sauna, è in una posizione assolutamente sicura e può essere separata dalla struttura con un pannello in Laminam®, materiale altamente tecnologico che consente una totale protezione dal calore. Il Laminam® non ha solo ottime prestazioni tecniche, ma anche un gradevole aspetto che ben si inserisce nell'accurata estetica della sauna.

*The stove, natural center of the sauna, is located in a safe place and it's isolated from the framework by a LAMINAM® panel, an highly technological material that allows a total protection from the heat. LAMINAM® doesn't have only good technical performances, but also a pleasant aspect that perfectly match with the accurate aesthetics of the sauna.*

# Cuna

## Sauna

### DIMENSIONI

200x142x204 H - x3/4 persone  
Potenza max: 4,5 kW  
205x127x204 H - x3 persone  
Potenza max: 3,6 kW  
165x127x204 H - x2/3 persone  
Potenza max: 3 kW  
150x127x204 H - x2/3 persone  
Potenza max: 3 kW  
205x92x204 H - x2/3 persone  
Potenza max: 3 kW  
165x92x204 H - x2 persone  
Potenza max: 2,3 kW  
120x127x204 H - x2 persone  
Potenza max: 2,3 kW  
120x92x204 H (in 2 versioni) - x1 persona  
Potenza max: 2,3 kW

Realizzazioni anche su misura

### MEASUREMENT

200x142x204 H - x3/4 persons  
Max power: 4.5 kW  
205x127x204 H - x3 persons  
Max power: 3.6 kW  
165x127x204 H - x2/3 persons  
Max power: 3 kW  
150x127x204 H - x2/3 persons  
Max power: 2.3 kW  
205x92x204 H - x2/3 persons  
Max power: 3 kW  
165x92x204 H - x2 persons  
Max power: 2.3 kW  
120x127x204 H - x2 persons  
Max power: 2.3 kW  
120x92x204 H (in 2 versions) - x1 persons  
Max power: 2.3 kW

Can be custom-made

### INSTALLAZIONE

Parete - Angolo - Nicchia

### CARATTERISTICHE

Mestolo in legno  
Mastellino in legno  
Mensola porta essenze / porta occhiali  
Porta salviette  
Struttura basamento con piedini regolabili  
Cromoterapia diffusa a Led RGB con 3 cicli, cambio colore automatico e funzione iride da 42 colori  
Chiusure vetro temperato, spessore 8 mm  
Stufa con pietre  
Pannello interno con lastra di protezione ultrapiatta Laminam® (finitura bronzo) posizionata dietro la stufa  
Pannello di controllo: pannello touch con finitura in vetro bianco

### INSTALLATION

Wall - Corner - Niche

### SPECIFICATIONS

Wooden ladle  
Wooden bucket  
Essence/glasses shelf  
Towel holder  
Base with adjustable feet  
RGB Led chromotherapy with 3 cycles, automatic colour change and 42-colour iris function  
Tempered glass enclosures, 8 mm thick  
Stove with stones  
Interior panel with super-flat Laminam® protection plate (bronze finish) placed behind the stove  
Display panel: touch screen panel with white glass finish

### ACCESSORI

Poggiaschiene double-face abachi  
Sistema audio con bluetooth

### FINITURE

Esterno: hemlock / hemlock e pannello frontale in wengè  
Interno: hemlock  
Arredamenti: abachi

### ACCESSORIES

Abachi wood reversible backrest  
Sound system with bluetooth

### FINISHES

Exterior: hemlock / hemlock and wenge front panel  
Interior: hemlock  
Furnitures: abachi wood

Misure disponibili / Available sizes



x 1

120 x 92 x 204 h  
Potenza max 2,3 kW



x 1

120 x 92 x 204 h  
Potenza max 2,3 kW



x 2

120 x 127 x 204 h  
Potenza max 2,3 kW



x 2/3

150 x 127 x 204 h  
Potenza max 2,3 kW



x 2

165 x 92 x 204 h  
Potenza max 2,3 kW



x 2/3

165 x 127 x 204 h  
Potenza max 3 kW



x 2/3

165 x 127 x 204 h  
Potenza max 3 kW



x 3

200 x 127 x 204 h  
Potenza max 3,6 kW



x 3/4

200 x 142 x 204 h  
Potenza max 4,5 kW



x 2/3

205 x 92 x 204 h  
Potenza max 2,3 kW



x 3

205 x 127 x 204 h  
Potenza max 3,6 kW

### FINITURE SAUNA \_ SAUNA FINISHES

Esterno  
Exterior

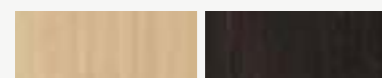

HEMLOCK

WENGÈ

Pannello frontale  
Front panel

Interno  
Interior

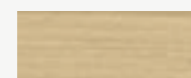

HEMLOCK

Perline orizzontali  
Horizontal  
matchboards

Arredamento  
Furniture



ABACHI

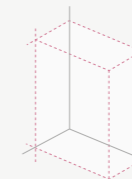

Optional

Misure personalizzate  
Custom-made



# TALIA

design Franco Bertoli

La sauna è realizzata interamente in abete di risonanza. L'illuminazione interna crea un particolare effetto raggiato grazie all'azione della luce diffusa da una speciale lampada sulle doghe del rivestimento. L'arredo è completato da una panca in abete. La maniglia sempre in legno è integrata in tutto il lato lungo della porta per una presa sicura ed una naturale presenza decorativa.

*The sauna is made entirely of fir resonance. The inner lighting creates a unique ray effect thanks to the diffused light fitted to the wooden staved wall. A fir bench completes the furnishing. The wooden handle is integrated on the entire length of the door to provide an easy, safe grip and a natural decorative presence.*

**Una sauna in abete per portare  
in casa la natura.**

*Bring nature to your home with  
a spruce wood sauna.*



SAUNAVITA®  
calore naturale



**DIMENSIONI**  
120x127x204 H

**CARATTERISTICHE**  
x2 persone  
potenza max 2,3 kW

**DIMENSIONS**  
120x127x204 H

**SPECIFICATIONS**  
x2 people  
max power 2,3 kW

## Talia

collection



Il pannello di controllo digitale permette di gestire tutte le funzioni della sauna con facilità. La lampada interna diffonde la luce con un particolare effetto raggiato.

*The digital display panel easily manages all the sauna's functions. The internal lamp create a unique ray effect.*

# Talia

## Sauna

### DIMENSIONI

300x192x204 H - x6 persone  
Potenza max: 9 kW  
250x192x204 H - x4/5 persone  
Potenza max: 9 kW  
200x192x204 H - x4 persone  
Potenza max: 6 kW  
200x142x204 H - x3/4 persone  
Potenza max: 4,5 kW  
160x127x204 H - x2/3 persone  
Potenza max: 3 kW  
120x127x204 H - x2 persone  
Potenza max: 2,3 kW  
120x92x204 H - x1 persona  
Potenza max: 2,3 kW

### Realizzazioni anche su misura

### INSTALLAZIONE

Parete - Angolo - Nicchia

### MEASUREMENT

300x192x204 H - x6 persons  
Max power: 9 kW  
250x192x204 H - x4/5 persons  
Max power: 9 kW  
200x192x204 H - x4 persons  
Max power: 6 kW  
200x142x204 H - x3/4 persons  
Max power: 4.5 kW  
160x127x204 H - x2/3 persons  
Max power: 3 kW  
120x127x204 H - x2 persons  
Max power: 2.3 kW  
120x92x204 H - x1 person  
Max power: 2.3 kW

### Can be custom-made

### INSTALLATION

Wall - Corner - Niche

### ACCESSORI SAUNA

Poggiaschiena double-face abete  
Poggiatesta abete  
Sistema audio con bluetooth  
Cromoterapia diffusa a Led RGB con 3 cicli, cambio colore automatico e funzione iride da 42 colori (sostituisce la lampada interna di serie)  
Fungo di emergenza  
Protezione in Laminam®

### CARATTERISTICHE

Mestolo in legno  
Mastellino in legno  
Mensola porta essenze / porta occhiali  
Porta salviette  
Porta accappatoi

### ACCESSORIES SAUNA

Reversible spruce backrest  
Spruce headrest  
Sound system with bluetooth  
RGB Led chromotherapy with 3 cycles, automatic colour change and 42-colour iris function (replaces the standard interior light)  
Emergency mushroom button  
Laminam® protection

### SPECIFICATIONS

Wooden ladle  
Wooden bucket  
Essence/glasses shelf  
Towel holder  
Bathrobe hook

### Lampada interna 220w

Basamento con piedini regolabili  
Porta vetro temperato, spessore 6 mm  
Cerniere regolabili su tre dimensioni  
Stufa con pietre  
Pannello di controllo: pannello digitale dotato di display grafico LCD blu retroilluminato a Led bianchi; orologio con datario, controllo e gestione tempo e temperatura; preimpostazione di accensione e clessidra elettronica

### FINITURE

Esterno: abete  
Interno: abete  
Arredamenti: abete

### 220w interior light

Base with adjustable feet  
Tempered glass door, 6 mm thick  
Three-dimensional adjustable hinges  
Stove with stones  
Display panel: digital panel equipped with white Led backlit blue LCD display; date clock, time and temperature control; switch-on pre-setting and electronic hour glass

### FINISHES

Exterior: spruce  
Interior: spruce  
Furnitures: spruce

### FINITURE SAUNA \_ SAUNA FINISHES

#### Esterno Exterior

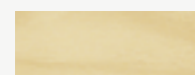

ABETE  
Perline verticali  
Vertical matchboard

#### Interno Interior

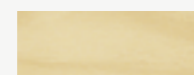

ABETE  
Perline verticali  
Vertical matchboard

#### Arredamento Furniture



ABETE

### Misure disponibili / Available sizes



x 6  
300 x 192 x 204 h  
Potenza max 9 kW



x 4/5  
250 x 192 x 204 h  
Potenza max 9 kW



x 4  
200 x 192 x 204 h  
Potenza max 6 kW



x 3/4  
200 x 142 x 204 h  
Potenza max 4,5 kW



x 2/3  
160 x 127 x 204 h  
Potenza max 3 kW



x 2  
120 x 127 x 204 h  
Potenza max 2,3 kW  
dx-sx



x 1  
120 x 92 x 204 h  
Potenza max 2,3 kW

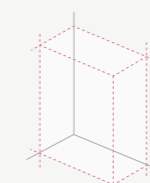

Optional  
**Misure personalizzate**  
Custom-made

# KYRA

design Franco Bertoli

Linee semplici e la continuità delle forme, Kyra trasforma la sauna in un oggetto d'arredo che si adatta ad ogni ambiente domestico.

La trasparenza del cristallo, la luce diffusa dalla lampada interna e i legni pregiati, infondono benessere e riportano alla più pura tradizione finlandese. Kyra è un bagno di calore che, grazie alla stufa con pietre vulcaniche, rigenera corpo e mente.

*Simple lines and continuity of shapes make this sauna a true piece of furniture that adapts to any domestic environment. The transparency of the crystal, the diffused light from the internal lamp and the precious woods, instill well-being and bring back to the purest Finnish tradition.*

*Kyra is a true heat bath, which thanks to the stove with lava stones regenerates body and mind.*

**Proprietà terapeutiche  
unite al design.**

*Therapeutic properties  
combined with design.*



# Kyra

collection



**DIMENSIONI**  
246x192x204 H

**CARATTERISTICHE**  
sauna finitura Hemlock

**DIMENSIONS**  
246x192x204 H

**SPECIFICATIONS**  
sauna Hemlock finish

**Kyra**  
collection



#### **Doghe in Abete nodato**

I nodi del legno e le doghe disposte in verticale caratterizzano una sauna naturale nell'essenza e moderna nel design.

#### ***Spruce wood slats with knots***

*The knots of the wood and the slats placed vertically make this sauna extremely natural in its essence and modern in its design.*



#### **Doghe in Hemlock**

Il calore del legno si unisce all'orientamento verticale delle doghe per esprimere lo stile nordico ed essenziale della sauna.

#### ***Hemlock slats***

*The warmth of the wood combined with the vertical slats summarises the essential Northern style of this sauna.*



Lampada interna  
*Internal lamp*



Camino per aerazione  
*Ventilation grid*



Cerniera  
*Hinge*



**Kyra**  
collection

**DIMENSIONI**  
246x192x204 H

**CARATTERISTICHE**  
sauna finitura Abete

**DIMENSIONS**  
246x192x204 H

**SPECIFICATIONS**  
sauna Spruce finish

# Kyra

collection

**DIMENSIONI**

192x192x204 H

**CARATTERISTICHE**

sauna finitura Abete

**DIMENSIONS**

192x192x204 H

**SPECIFICATIONS**

sauna Spruce finish





# Kyra

collection



Le funzioni della sauna sono controllate da una tastiera digitale, di facile utilizzo, perfettamente integrata nella forma e nello stile di Kyra.

*The sauna functions are controlled on a touch screen, easy to use, which blends in seamlessly with the structure and style of Kyra.*



**DIMENSIONI**  
150x120x215 H

**CARATTERISTICHE**  
sauna finitura Hemlock

**DIMENSIONS**  
150x120x215 H

**SPECIFICATIONS**  
sauna Hemlock finish

# Kyra

## Sauna

### DIMENSIONI

Sauna 246x246x204 H - x6 persone  
Potenza max: 9 kW / con Biosauna  
potenza max: 11 kW

Sauna 246x192x204 H - x5/6 persone  
Potenza max: 9 kW / con Biosauna  
potenza max: 11 kW

Sauna 246x156x204 H - x5 persone  
Potenza max: 6 kW / con Biosauna  
potenza max: 8 kW

Sauna 192x192x204 H - x4/5 persone  
Potenza max: 6 kW / con Biosauna  
potenza max: 8 kW

Sauna 192x156x204 H - x4 persone  
Potenza max: 4,5 kW / con Biosauna  
potenza max: 6,5 kW

Sauna 192x120x204 H - x3/4 persone  
Potenza max: 3,6 kW

Sauna 156x156x204 H - x3/4 persone  
Potenza max: 4,5 kW

Sauna 156x120x204 H - x2/3 persone  
Potenza max: 3 kW

Sauna 156x102x204 H - x2 persone  
Potenza max: 3 kW

### MEASUREMENT

Sauna 246x246x204 H - x6 persons  
Max power: 9 kW / With Biosauna max  
power: 11 kW

Sauna 246x192x204 H - x5/6 persons  
Max power: 9 kW / With Biosauna max  
power: 11 kW

Sauna 246x156x204 H - x5 persons  
Max power: 6 kW / With Biosauna max  
power: 8 kW

Sauna 192x192x204 H - x4/5 persons  
Max power: 6 kW / With Biosauna max  
power: 8 kW

Sauna 192x156x204 H - x4 persons  
Max power: 4.5 kW / With Biosauna max  
power: 6,5 kW

Sauna 192x120x204 H - x3/4 persons  
Max power: 4.5 kW

Sauna 156x156x204 H - x3/4 persons  
Max power: 3.6 kW

Sauna 156x120x204 H - x2/3 persons  
Max power: 3 kW

Sauna 156x102x204 H - x2 persons  
Max power: 3 kW

Sauna 120x120x204 H - x1 persona

Potenza max: 2,3 kW

Sauna 120x102x204 H - x1 persona

Potenza max: 2,3 kW

### INSTALLAZIONE

Parete - Angolo - Nicchia

### CARATTERISTICHE

Mestolo in legno

Mastellino in legno

Lampada interna 220w

Basamento con piedini regolabili

Porta vetro temperato, spessore 8 mm

Cerniere per posizionamento porta 90°  
verso l'esterno

Stufa con pietre laviche

Pannello di controllo: pannello digitale  
retroilluminato a Led (funzione On/Off  
- Luce - selezione Temperatura)

Clessidra

Sauna 120x120x204 H - x1 person

Max power: 2.3 kW

Sauna 120x102x204 H - x1 person

Max power: 2.3 kW

### INSTALLATION

Wall - Corner - Niche

### SPECIFICATIONS

Wooden ladle

Wooden bucket

220w interior light

Base with adjustable feet

Tempered glass door, 8 mm thick

Hinges for door opening 90° outwards

Stove with stones

Display panel: Led backlit digital panel  
(On/Off - Light - Temperature selection)

Hourglass

### OPTIONAL SAUNA

Poggiaschiene double-face abachi

Poggiatesta abachi

Cromoterapia

Fungo di emergenza

Sistema audio con bluetooth

Modulo USB/AUX

### FINITURE

Esterno: abete / hemlock

Interno: abete / hemlock

Arredamenti: abachi

Coimbentazione in lana di roccia

### OPTIONAL SAUNA

Reversible abachi wood backrest

Abachi wood headrest

Chromotherapy

Emergency mushroom button

sound system with bluetooth

USB AUX module

### FINISHES

Exterior: spruce / hemlock

Interior: spruce / hemlock

Furnitures: abachi wood

Rockwool insulation

### FINITURE SAUNA \_ SAUNA FINISHES

Esterno e interno  
Exterior and interior



ABETE NODATO

HEMLOCK

Perline verticali  
Vertical matchboard

Perline verticali  
Vertical matchboard

Arredamento  
Furniture

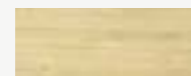

ABACHI

Misure disponibili / Available sizes



x 1

120 x 102 x 204 h  
Potenza max 2,3 kW



x 2

120 x 120 x 204 h  
Potenza max 3 kW



x 2

156 x 102 x 204 h  
Potenza max 3 kW



x 2/3

156 x 120 x 204 h  
Potenza max 3 kW



x 3/4

156 x 156 x 204 h  
Potenza max 4,5 kW



x 3/4

192 x 120 x 204 h  
Potenza max 3,6 kW



x 4

192 x 156 x 204 h  
Potenza max 4,5 kW  
Biosauna 6,5 kW\*



x 4/5

192 x 192 x 204 h  
Potenza max 6 kW  
Biosauna 8 kW\*



x 5

246 x 156 x 204 h  
Potenza max 6 kW  
Biosauna 8 kW\*



x 5/6

246 x 192 x 204 h  
Potenza max 9 kW  
Biosauna 11 kW\*

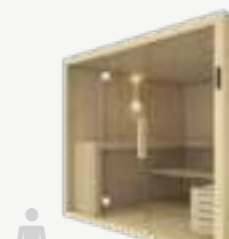

x 6

246 x 246 x 204 h  
Potenza max 9 kW  
Biosauna 11 kW\*

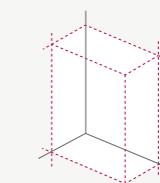

Optional  
**Misure personalizzate**  
Custom-made

\* potenza massima - max power

# SAUNE OUTDOOR

*Outdoor saunas*

---

Possibili realizzazioni a progetto di saune per esterno. Sauna Vita ti permette di vivere l'esperienza della sauna anche negli spazi esterni, per bagni di calore immersi nella natura. Le saune outdoor diventano oasi di benessere in cui rilassarsi da soli o da condividere con gli altri.

*Possible projects for outdoor saunas. Sauna Vita allows you to experience the sauna experience even in outdoor spaces, for heat baths immersed in nature. Outdoor saunas become an oasis of well-being in which to relax alone or in good company.*

SAUNAVITA®  
calore naturale

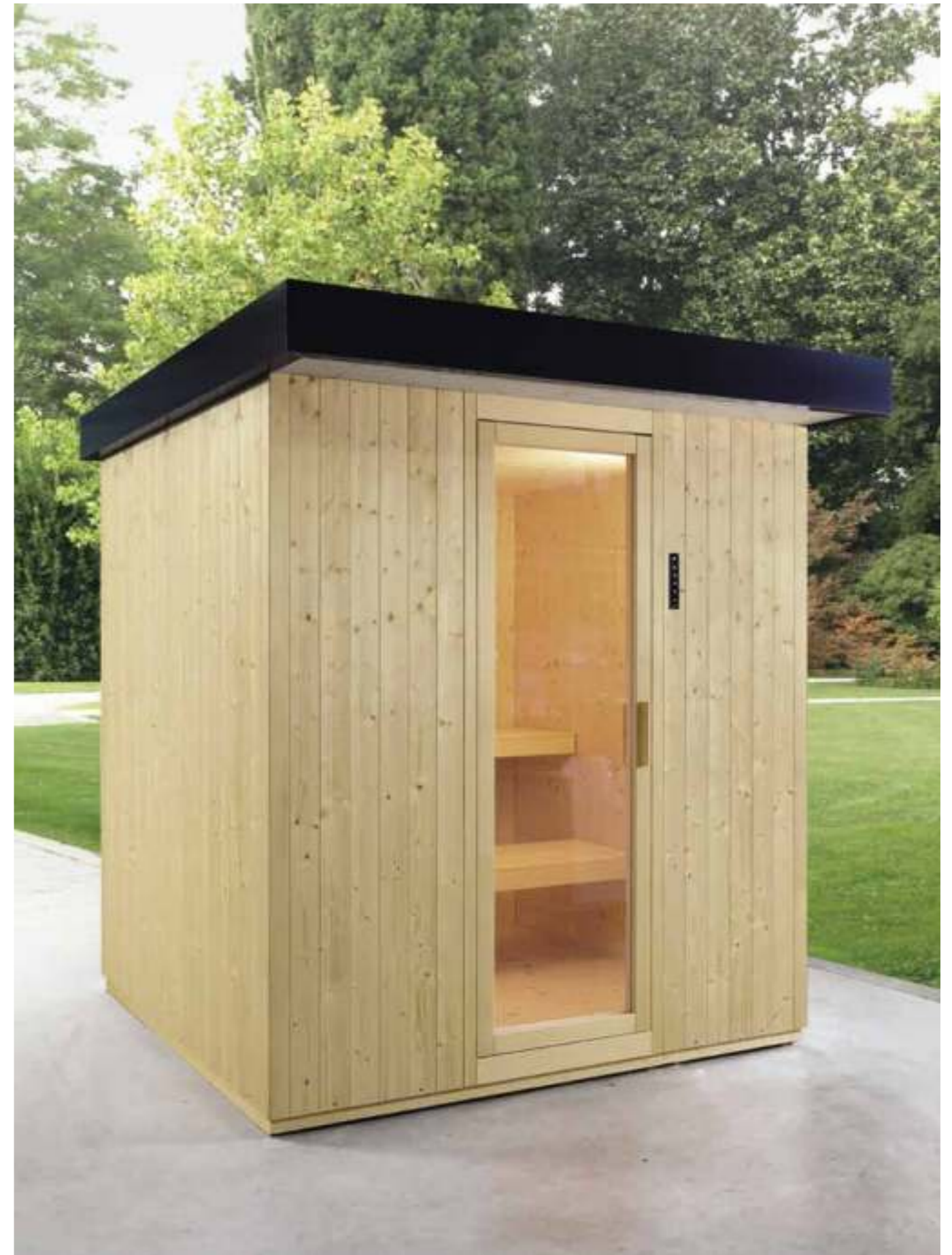



Ogni elemento della sauna è testimone di qualità e pregio: dai materiali, al design, fino ai dettagli più piccoli, come le cerniere.

*Each element of the sauna is a testimony to quality and value: from materials, to design, to the smallest details, such as hinges.*



Discreto e pratico, il tastierino touch consente di impostare dall'esterno la temperatura. Un elemento funzionale che si integra perfettamente con lo stile della sauna.

*Discreet and practical, the touch digital control allows you to set the temperature from outside. A functional element that integrates perfectly with the style of the sauna.*



La porta battente sigilla l'ambiente, garantendo che all'interno la temperatura rimanga costante, senza essere influenzata dalle condizioni esterne.

*The hinged door seals the sauna area, ensuring that the temperature remains constant inside, without being influenced by external conditions.*

# SOFFIONE EMOZIONALE

*Multi-sensory shower head*

Due programmi per stimolare tutti i sensi.

Dopo la sauna, l'ideale è concedersi una doccia di benessere per ridurre la temperatura del corpo e prolungare il relax. Il soffione emozionale, rettangolare o rotondo, è composto da due programmi e una doccia verticale: la "nebbia fredda" nebulizzata con essenza Balsamic e cromoterapia blu crea una piacevole sensazione di freschezza; la "cascata tropicale" calda fa scorrere l'acqua infondendo energia attraverso la cromoterapia con luce rossa e l'essenza Vanilla. Un benessere completo.

*Two programs to stimulate all the senses. After the sauna, take a shower to reduce the body temperature and extend your moment of relaxation.*

*The emotional shower head, rectangular or round, is composed of two programs and a vertical shower: the sprayed cold mist with Balsamic essence and blue chromotherapy creates a pleasant sensation of freshness; the hot "tropical cascade" makes the water flow, infusing energy through chromotherapy with red light and the essence of Vanilla. For a complete well-being.*



## Esempio di installazione in una cabina doccia.

*Example of shower cabin installation.*

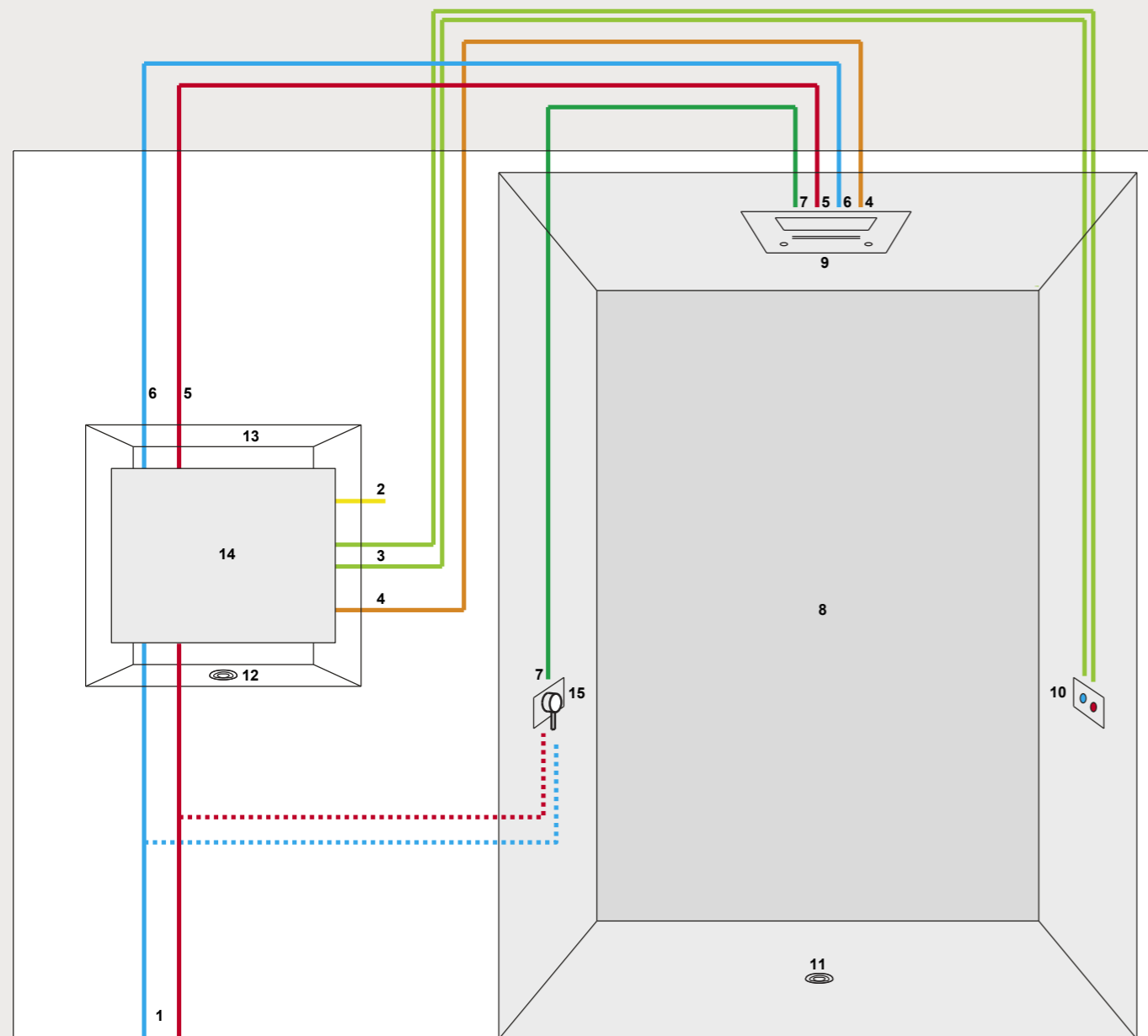

### DETTAGLI TECNICI

1. Alimentazione acqua calda e fredda
2. Alimentazione elettrica
3. Collegamento tastiera
4. Collegamento cromoterapia
5. Uscita acqua calda (per cascata)
6. Uscita acqua fredda (per nebulizzatori)
7. Uscita acqua miscelata (per soffione)
8. Cabina doccia
9. Soffione emozionale acciaio lucido
10. Tastiera
11. Scarico
12. Scarico opzionale di sicurezza
13. Vano tecnico
14. Pannello elettroidraulico
15. Miscelatore

### TECHNICAL DETAILS

1. *Hot and cold water supply*
2. *Power supply*
3. *Keyboard shortcut*
4. *Nk chromotherapy*
5. *Hot water output (for cascading)*
6. *Cold water outlet (for nebulizers)*
7. *Water mixer output (for head)*
8. *Shower cabin*
9. *Showerheads emotional polished steel*
10. *Keyboard*
11. *Exhaust*
12. *Discharge of security optional*
13. *Technical room*
14. *Electro panel*
15. *Mixer*

#### Soffione rotondo Round showerheads

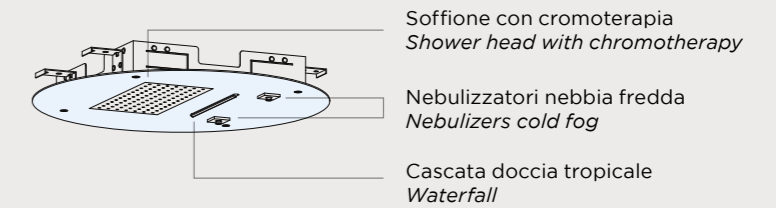

#### Soffione rettangolare Rectangular showerheads

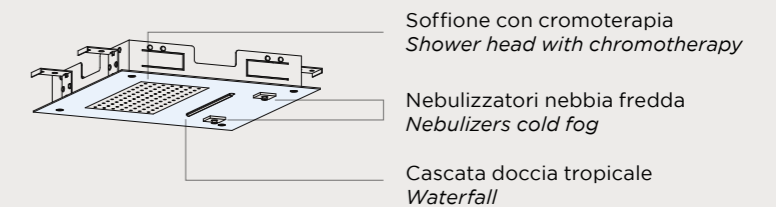

#### Tastiera Keyboard

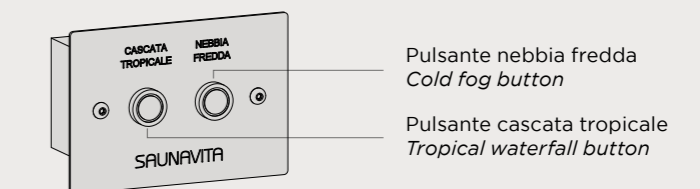

# DOCCIA SCOZZESE

*Bucket shower*

Per rinfrescare intensamente e velocemente il corpo dopo la sauna.  
L'impianto è composto da un mastellino in Larice verniciato con una capacità dai 4,5 ai 7,5 litri, provvisto di supporto da fissare a parete, di attacco per l'alimentazione idraulica e di galleggiante per il riempimento automatico. Il mastellino si riempie automaticamente di acqua fredda e tirando una catenella lunga 65 cm il mastellino rovescia di colpo l'acqua sulla persona sottostante.

To cool intensely and quickly our body after sauna.

Shower bucket is made by treated larch wood with capacity from 4.5 to 7.5 liters, provided with a support for wall fixing, hydraulic connections and floater for automatic filling. Bucket will be automatically filled with cold water and pushing a 65 cm long side chain it shots water on the person below.



## Installazione doccia scozzese

### Installation bucket shower

#### INSTALLAZIONE A SOFFITTO

##### Ceiling installation

Fisso \_ Fixed

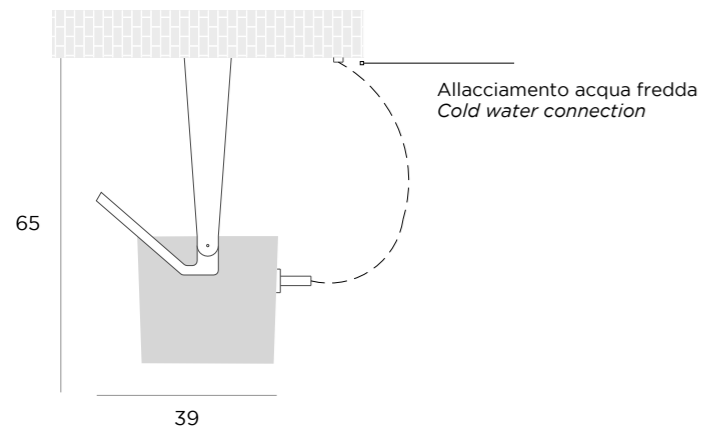

In azione \_ In action

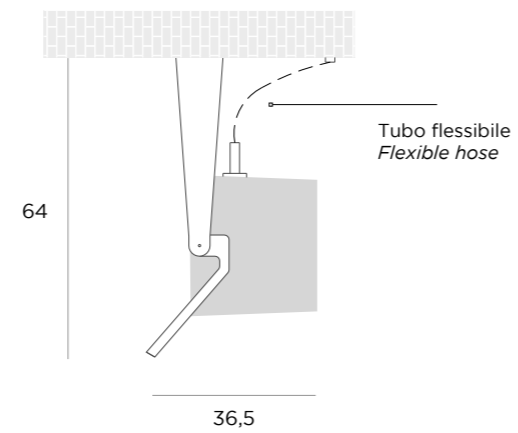

#### INSTALLAZIONE A PARETE

##### Wall installation

Fisso \_ Fixed

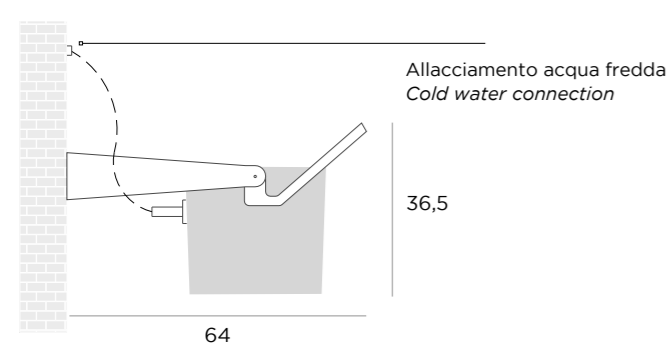

In azione \_ In action

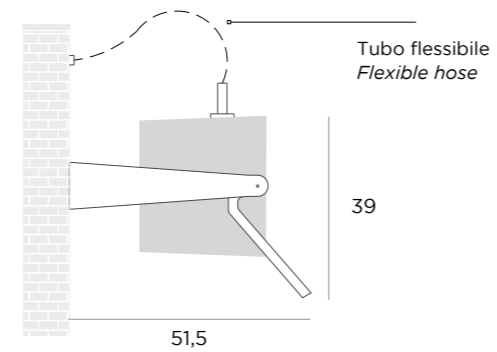





## HAMMAM

---

**Generatori di vapore**  
*Steam generator*

**Sv Steam** <sup>178</sup>

**Sv Steam Mini** <sup>191</sup>

**Sv Steam Urus** <sup>192</sup>

**Sv Steam Plus** <sup>193</sup>

**Strutture in EPS e soffitti** <sup>196</sup>  
*Smooth EPS structures and ceilings*

**Porte e vetrate con tenuta vapore** <sup>198</sup>  
*Steam seal doors and windows*

Circondati da una nebbia tiepida e avvolgente, ci si abbandona ad una profonda sensazione di relax. All'interno dell'Hamam, la temperatura si aggira intorno ai 45° C e il tasso di umidità arriva al 100%. Rispetto alla sauna, il calore meno intenso e il vapore consentono una permanenza più lunga e una maggiore perdita di liquidi. L'intensa sudorazione porta equilibrio e benessere in tutto il corpo. I pori si dilatano e la pelle si purifica in profondità risultando più elastica e luminosa. Il bagno turco facilita l'eliminazione delle tossine, favorendo la regolazione nervosa e ormonale, con effetti positivi sullo stress, le tensioni muscolari e i dolori reumatici. Inoltre, allevia le infiammazioni alle vie respiratorie e aiuta a combattere l'insonnia e i segni dell'invecchiamento. Entrare in un bagno di vapore significa lasciarsi circondare e invadere dai suoi effluvi benefici, ci si concentra su sé stessi e sull'ascolto del proprio corpo, sperimentando una rigenerante sensazione di calma e distensione.

*Let its warm and relaxing mist envelop you. The temperature in a Turkish bath is around 45 °C with a 100% humidity rate. The less intense heat compared to the sauna and the steam allow you to stay longer and for greater fluid loss. Intense transpiration brings balance and wellbeing to your whole body. Pores open and your skin is purified in depth becoming bouncier and more radiant. The Turkish bath helps eliminate toxins while promoting nervous and hormonal balance and combating stress, muscle tension, and rheumatic pain. Moreover, it alleviates airway inflammation and helps counter insomnia and signs of ageing. When you step into a steam bath, you focus on yourself and on listening to your body while experiencing a regenerating sensation of calmness and relaxation.*

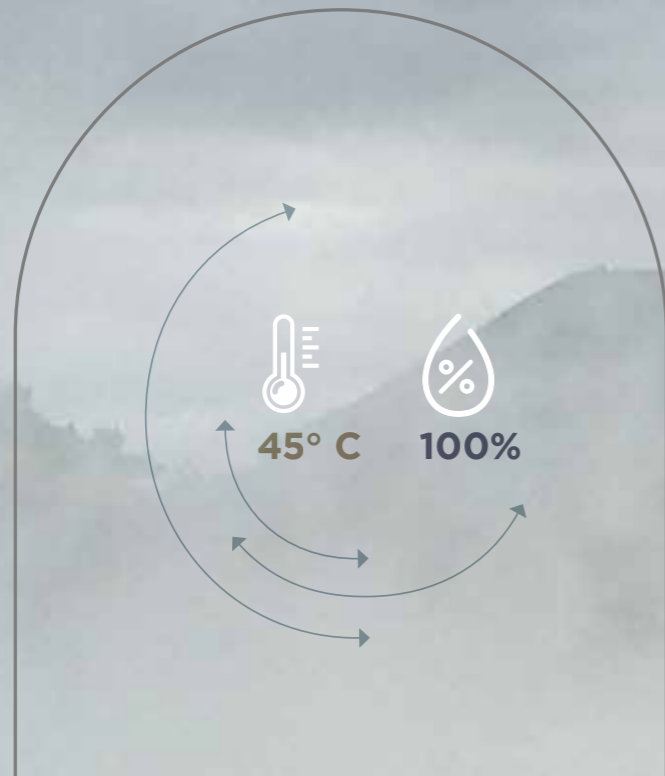

## LA FORZA BENEFICA DEL VAPORE

*The power of steam*

Una delle più radicate certezze dell'uomo è che l'acqua è fonte di vita. Anche quando assume la forma di una calda nuvola di vapore, questo elemento può agire positivamente e in profondità sulla salute del corpo.

Lo sapevano bene in tempi lontani i popoli orientali e i romani, per i quali la SPA (salus per aquam) e i bagni di vapore erano parte integrante della vita quotidiana.

Oggi, il bagno turco sfrutta nuovi materiali e nuove tecnologie, per perfezionare ed amplificare gli effetti positivi di questa pratica antica.

*One of few certainties of humankind is that water is a source of life. When it takes the form of a warm cloud of steam, it can even have a deep and positive impact on your body's health. Oriental populations and the Romans already knew this in ancient times. In fact, spas (salus per aquam) and steam baths were an integral part of their day-to-day life. Today, Turkish baths exploit new technologies and materials to amplify the positive effects of this ancient ritual.*

# SV STEAM

collection

Il design sobrio, il colore bianco e le dimensioni ridotte rendono Sv Steam un oggetto d'arredo che può essere installato a vista. Il generatore di vapore per hammam unisce design e prestazioni per rispondere alle nuove esigenze estetiche e funzionali degli ambienti wellness. Una porta in cristallo permette il corretto funzionamento del bagno turco e contiene la massima tecnologia oggi espressa nel campo della produzione di vapore. La tastiera touch rende facile e intuitivo l'utilizzo e il controllo di tutte le funzioni.

*The sober design, the white colour and the small size make Sv Steam a piece of furniture that can be installed on sight. The steam generator for Turkish baths combines design and performance to meet the new aesthetic and functional needs of wellness environments. A glass door allows the correct operation of the Turkish bath and contains the highest technology expressed today in the field of steam production. The display panel makes it easy and intuitive to use and controls all functions.*

**Il generatore di vapore diventa  
elemento d'arredo.**

*The steam generator turns  
into a piece of furniture.*



# GENERATORE DI VAPORE PER LA CASA E LA SPA

## Steam generator for your home and spa

SV STEAM offre più soluzioni di hammam per la casa e le Spa, con una diversa localizzazione del generatore di vapore: da incassare o posizionare in vani tecnici dedicati. Tecnologia avanzata per una nuova modalità di allestimento.

*Two different hammam proposals, both for residential and Spa, with two different positions of the steam generator: encased into the wall or installed externally in a technical space. Advanced technology to create a new way of setting up.*

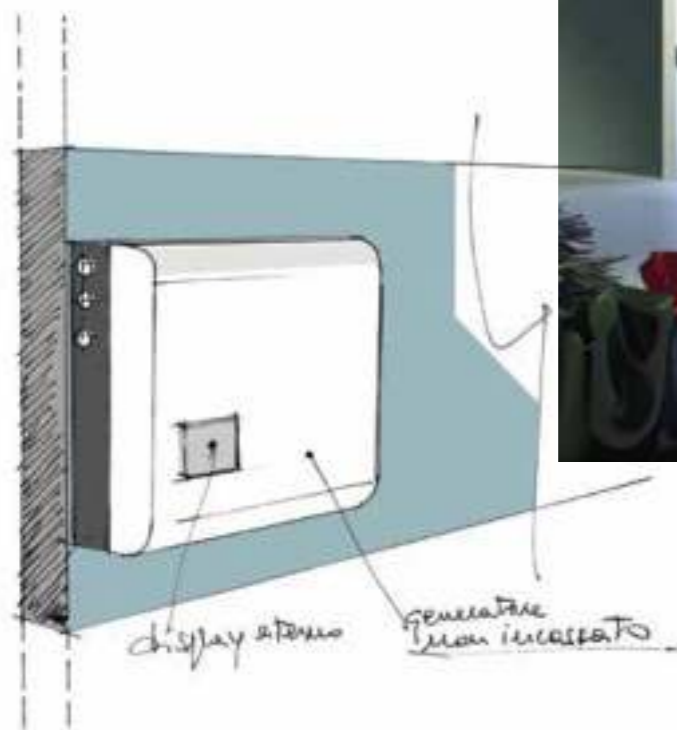

## PERSONALIZZAZIONE E COMFORT

### Customisation and comfort

È possibile rendere unico l'hammam con angoli lavabo e sedute a muro rivestibili, lineari o curve, con o senza schienale. Un'ampia gamma di soluzioni per venire incontro ad ogni esigenza di spazio, stile e comodità, sia in casa che negli ambienti professionali.

*Make your Turkish bath unique with washbasins and wall-mount coverable seats (linear or curved) with or without a backrest. A wide range of solutions to meet any requirement of space, style, and comfort both at home and in professional settings.*



## Sv Steam

collection



### Sv Steam MINI

**CARATTERISTICHE**  
stanza 160 x 160 con generatore  
sv steam mini esterno

**SPECIFICATIONS**  
160 x 160 with exterior version  
mounting small steam generator

## Sv Steam

collection



### Sv Steam

senza display a bordo  
without LCD integrated display

### CARATTERISTICHE

stanza 250x150 con generatore  
sv steam semi-incasso

### SPECIFICATIONS

250x150 with semi-encased  
mounting steam generator

# Sv Steam

collection

## STRUTTURA PORTANTE IN EPS

*Support structure in EPS*

Il polistirene espanso sinterizzato è un materiale atossico, caratterizzato da un elevato isolamento termico e una grande resistenza all'umidità, perfetto per la coibentazione del bagno turco. La struttura in EPS può essere rivestita con mosaici o altri tipi di rivestimento.

*The sintered polystyrene foam is a non-toxic material, characterized by a high thermal insulation and a great resistance to humidity, perfect for the insulation of the Turkish bath. The EPS structure can be covered with mosaics or other types of coating.*

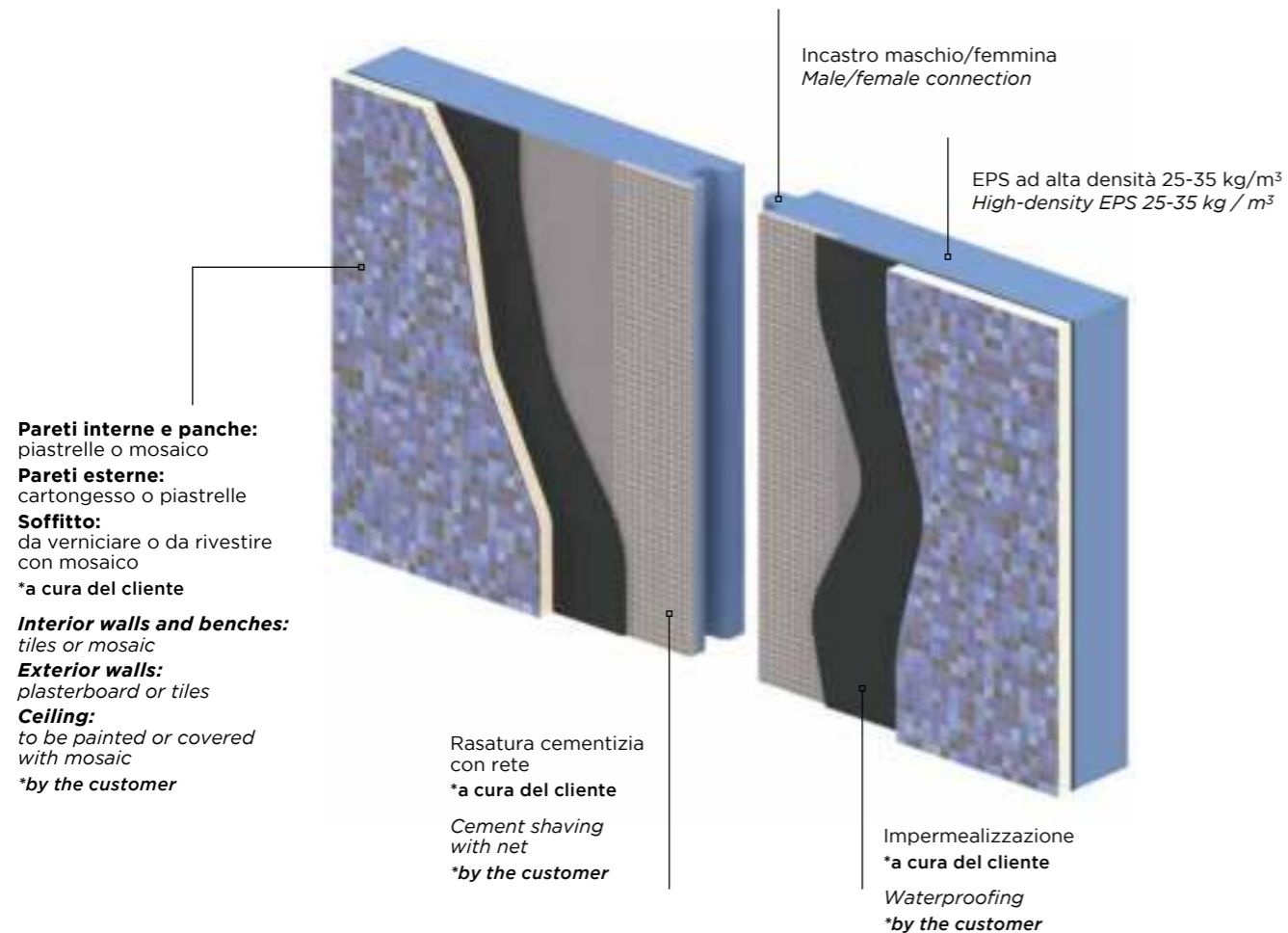

# Hai uno spazio dove creare il tuo hammam?

Realizzalo con le nostre strutture coibentate e i generatori di vapore.

*Do you have a space to create your hammam?  
Realize it with our insulated structures and steam generators.*

1

## MISURA LO SPAZIO Measure the space

Individua lo spazio nell'ambiente bagno o in un'altra stanza dedicata dove poter realizzare il tuo angolo relax: c'è una soluzione adatta a tutte le misure.

*Locate the space in the bathroom or another dedicated room where you can make your own relaxation corner: there is a solution suitable for all sizes.*

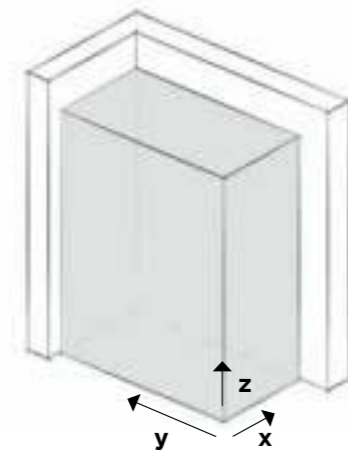

2

## SCEGLI IL GENERATORE DI VAPORE Choose the steam generator

Ad incasso oppure all'esterno in un apposito vano tecnico, per grandi spazi o piccoli ambienti: scegli il modello più adatto alle tue esigenze.

*Recessed or outside in a special technical compartment, for large spaces or small areas: choose the model that best suits your needs.*

SV STEAM



SV STEAM MINI



SV STEAM PLUS



per grandi ambienti  
for large environments

SV STEAM URUS



3

## DEFINISCI TUTTE LE PARTI DELLA STRUTTURA Choose all parts of the structure

Pareti, soffitto, porta e rivestimenti: personalizza tutti gli elementi dell'hammam nelle misure, nelle finiture e anche nella funzionalità.

*Walls, ceiling, door and coverings: customize all the elements of the hammam in the sizes, finishes and functionality.*

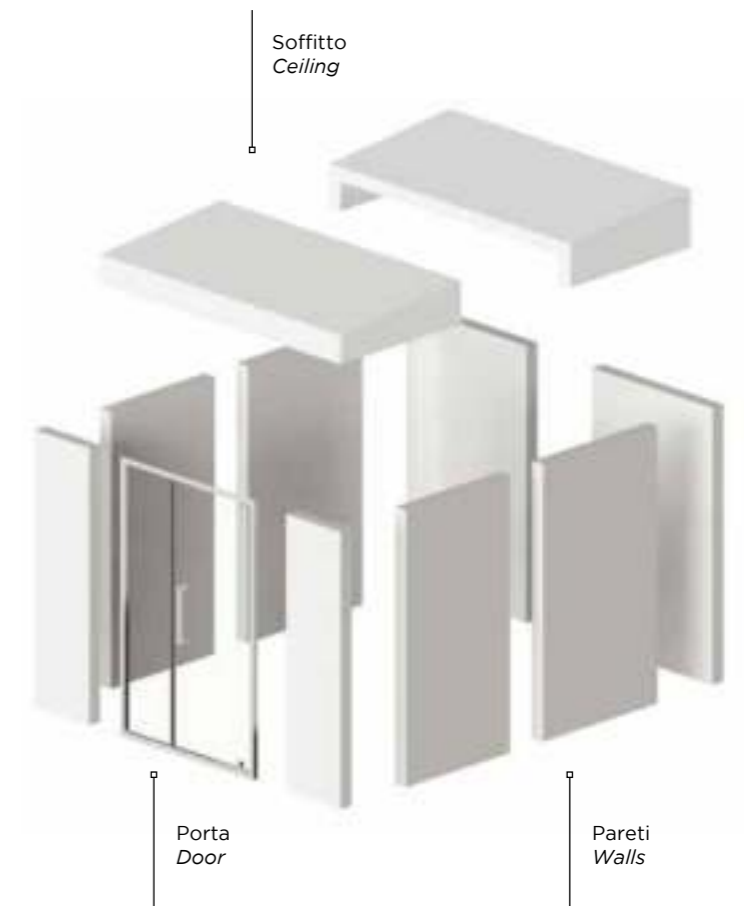

4

## SCEGLI LA TIPOLOGIA DI SEDUTA Vedi pag. 189

Choose the type of sitting See page 189

Con schienale o senza schienale, scegli la seduta ideale per il tuo spazio e la tua idea di comodità.

*With back or without back choose the ideal seat for your space and your idea of comfort.*

Seduca con schienale  
Seat with backrestSeduca senza schienale  
Seat without backrestSeduta curva  
Curved seat

5

## COMPLETA LO SPAZIO CON GLI ACCESSORI Vedi pag. 191

Complete the space with accessories See page 191



Touch screen LCD

Casse musica  
Music speakersSoffione con cromoterapia  
Shower head with colour therapyLuce e cromoterapia  
Light and colour therapy



## Modelli di generatori di vapore

### Steam generator models



### SV STEAM

#### DIMENSIONI

Installazione esterno muro  
52x18x44 H  
Potenza max: 12 kW  
Installazione semincasso  
mediante cassa in acciaio  
52x9x44 H  
Potenza max: 12 kW  
kW 12 - max 12,5 m<sup>3</sup>  
kW 10,5 - max 11 m<sup>3</sup>  
kW 9 - max 9,5 m<sup>3</sup>  
kW 7,5 - max 7,5 m<sup>3</sup>  
kW 6 - max 6 m<sup>3</sup>  
kW 5 - max 5 m<sup>3</sup>  
kW 4 - max 4 m<sup>3</sup>

#### MEASUREMENT

Exterior wall installation  
52x18x44 H  
Max power: 12 kW  
Semi built-in installation  
via steel casing  
52x9x44 H  
Max power: 12 kW  
kW 12 - max 12.5 m<sup>3</sup>  
kW 10.5 - max 11 m<sup>3</sup>  
kW 9 - max 9.5 m<sup>3</sup>  
kW 7.5 - max 7.5 m<sup>3</sup>  
kW 6 - max 6 m<sup>3</sup>  
kW 5 - max 5 m<sup>3</sup>  
kW 4 - max 4 m<sup>3</sup>

#### CARATTERISTICHE

Sistema di decalcificazione per caldaia  
Erogatore vapore con dispenser per aromaterapia  
Display programmazione settimanale a fasce orarie  
Gestione di:  
Luce-cromoterapia  
Sistema audio  
Programmazione settimanale  
Ventilatore  
USB / AUX  
Predisposto per:  
Pompe peristaltiche (2 aromi)

#### SPECIFICATIONS

Boiler descaling system  
Steam dispenser with aromatherapy diffuser  
Display weekly programming in time slots  
Control of:  
Light-chromotherapy  
Sound system  
Weekly programming  
Fan  
USB / AUX  
Enables the installation of:  
peristaltic pumps (2 aromas)

#### FINITURA

Bianco

#### FINISH

White

#### ESTERNO MURO

Exterior wall

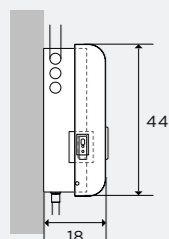

#### SEMINCASSO MURO

Semi built-in

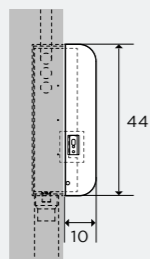

#### PARTICOLARI

Details



USB / AUX



Display

#### ESTERNO MURO

Exterior wall

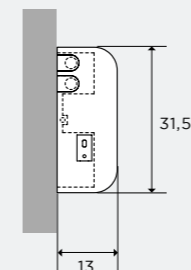

### SV STEAM MINI

#### DIMENSIONI

58x13x31,5 H  
Potenza max: 5 kW  
kW 5 - max 5,5 m<sup>3</sup>  
kW 4 - max 4,5 m<sup>3</sup>  
kW 3 - max 3,5 m<sup>3</sup>

#### INSTALLAZIONE

Esterno muro

#### MEASUREMENT

58x13x31.5 H  
Max power: 5 kW  
kW 5 - max 5.5 m<sup>3</sup>  
kW 4 - max 4.5 m<sup>3</sup>  
kW 3 - max 3.5 m<sup>3</sup>

#### INSTALLATION

Exterior wall

#### CARATTERISTICHE

Sistema di decalcificazione per caldaia  
Erogatore vapore con dispenser per aromaterapia  
Display  
Gestione di:  
Luce-cromoterapia  
Sistema audio  
Programmazione settimanale  
USB / AUX

#### SPECIFICATIONS

Boiler descaling system  
Steam dispenser with aromatherapy diffuser  
Display  
Control of:  
Light-chromotherapy  
Sound system  
Weekly programming  
USB / AUX

#### FINITURE

Bianco

#### FINISHING

White

#### PARTICOLARI

Details



USB / AUX



Display



## SV STEAM URUS

### DIMENSIONI

37x50x28 H  
Potenza max: 12 kW  
kW 4 - max 6 m<sup>3</sup>  
kW 6 - max 9 m<sup>3</sup>  
kW 9 - max 12 m<sup>3</sup>  
kW 12 - max 18 m<sup>3</sup>

### CARATTERISTICHE

Ideale per posizionamento su vani tecnici e a soffitto  
Erogatore vapore con dispenser per aromaterapia  
Display programmazione settimanale a fasce orarie  
Gestione di:  
Luce-cromoterapia  
Sistema audio  
Programmazione settimanale  
Ventilatore  
USB / AUX  
Predisposto per:  
Pompe peristaltiche (2 aromi)  
Piedini regolabili per appoggio a soffitto

### FINITURA

Acciaio Inox

### MEASUREMENT

37x50x28 H  
Max power: 48 kW  
kW 4 - max 6 m<sup>3</sup>  
kW 6 - max 9 m<sup>3</sup>  
kW 9 - max 12 m<sup>3</sup>  
kW 12 - max 18 m<sup>3</sup>

### SPECIFICATIONS

Ideal for positioning on technical and ceiling areas  
Steam dispenser with aromatherapy diffuser  
Display weekly programming in time slots  
Control of:  
Light-chromotherapy  
Sound system  
Weekly programming  
Fan  
USB / AUX  
Enables the installation of:  
peristaltic pumps (2 aromas)  
Adjustable feet for ceiling support

### FINISH

Stainless steel

### DIMENSIONI Measurement

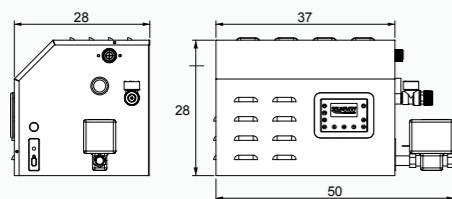

### PARTICOLARI Details



Display

## Generatore di vapore ad elettrodi immersi Immersed electrode steam generators



## SV STEAM PLUS

### DIMENSIONI

36,5x27,5x71,2 H  
54,5x37,5x81,5 H  
63,5x46,5x89 H  
Potenza max: 48 kW  
kW 14 - max 18 kg/h  
kW 18 - max 25 kg/h  
kW 26 - max 35 kg/h  
kW 33 - max 45 kg/h  
kW 48 - max 65 kg/h

### CARATTERISTICHE

Display grafico remotabile  
Gestione fasce orarie e temperature con programmazione giornaliera o settimanale sonda passiva di temperatura  
Predisposto per:  
La gestione essenze e ciclo di attivazione (fino a 3 essenze max)  
Ciclo di sanificazione  
Controllo di due ventilatori  
On-off per la gestione della luce interna da display  
Richiede la predisposizione di un vano tecnico

### ACCESSORI

Kit remotazione terminale per umidificatori  
Tubo vap. spiral. acc. D.= 30 mm  
Kit uscita vapore UE 25-65 kg/H y + tubo  
Distributore con foro cieco (2 pezzi)  
Kit double check valve  
Tubo gomma radio di 40x50 - 1 metro lineare  
Modulo audio alimentato a 230V con ingresso USB-AUX e gestione cromoterapia con display LCD integrato  
Disponibili casse audio + faro cromoterapia-luce

### MEASUREMENT

36.5x27.5x71.2 H  
54.5x37.5x81.5 H  
63.5x46.5x89 H  
Max power: 48 kW  
kW 14 - max 18 kg/h  
kW 18 - max 25 kg/h  
kW 26 - max 35 kg/h  
kW 33 - max 45 kg/h  
kW 48 - max 65 kg/h

### SPECIFICATIONS

Weekly or daily programming of time slots and temperature passive temperature sensor  
Enables the installation of:  
Essence management and activation cycle (up to 3 essences)  
Sanitation cycle  
Control of two fans  
On-off management of the display interior light  
It requires the preparation of a technical compartment

### ACCESSORIES

Terminal remoting kit for humidifiers  
Spiral steel steam tube D.= 30 mm  
Steam outlet kit UE 25-65 kg/H y + tube  
Dispenser with blind hold (2 pieces)  
Double check valve kit  
Rubber hose 40x50 radio 1 linear metre  
230V sound system with USB-AUX input and chromotherapy with built-in LCD display  
Speakers-chromotherapy light available

### DIMENSIONI Measurement

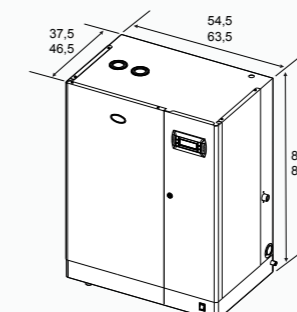
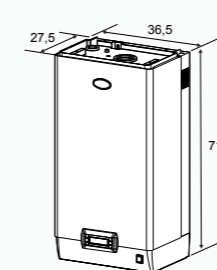

### PARTICOLARI Details



Display

## Tipologie di installazione

### Steam generator models

#### Installazione SV STEAM su vani tecnici (esterno muro)

Ideale per l'utilizzo professionale. La gestione delle funzioni può essere controllata direttamente, con display a bordo del generatore di vapore, o in modalità remota tramite display LCD.

#### SV STEAM installation on technical compartments (exterior wall)

Wall installation is ideal for the professional use. Selection of functions can be managed directly through a LCD integrated display, or managed remotely.



#### Installazione SV STEAM a vista (semi-incasso)

Il generatore a semi-incasso diventa elemento d'arredo, elegante e lineare. Il display LCD, posto all'interno dell'hammam, permette il controllo di tutte le funzioni. Ideale per l'utilizzo domestico.

#### SV STEAM installation (semirecessed)

Semi-encased steam generator becomes a design element, elegant and with clean style. LCD display enables to manage every function from the inside of the hammam.



#### Installazione SV STEAM URUS per soffitto o vano tecnico

Dimensioni studiate per poterlo inserire in vani molto bassi grazie alla sua altezza di soli 28 cm.

#### SV STEAM URUS installation for ceiling or technical room

Dimensions are designed to be able to place the steam generator in very low rooms thanks to its height of only 28 cm.

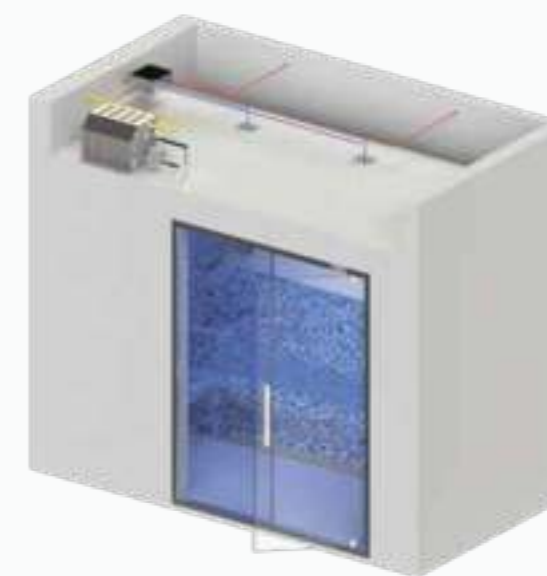

#### Installazione SV STEAM PLUS per grandi ambienti

Il generatore di vapore ha maggiori dimensioni e potenza per soddisfare ambienti voluminosi e garantire temperatura e umidità uniformi.

#### SV STEAM PLUS installation for large environments

Steam generator has greater dimensions and power to satisfy high volume areas to provide uniform temperature and humidity.

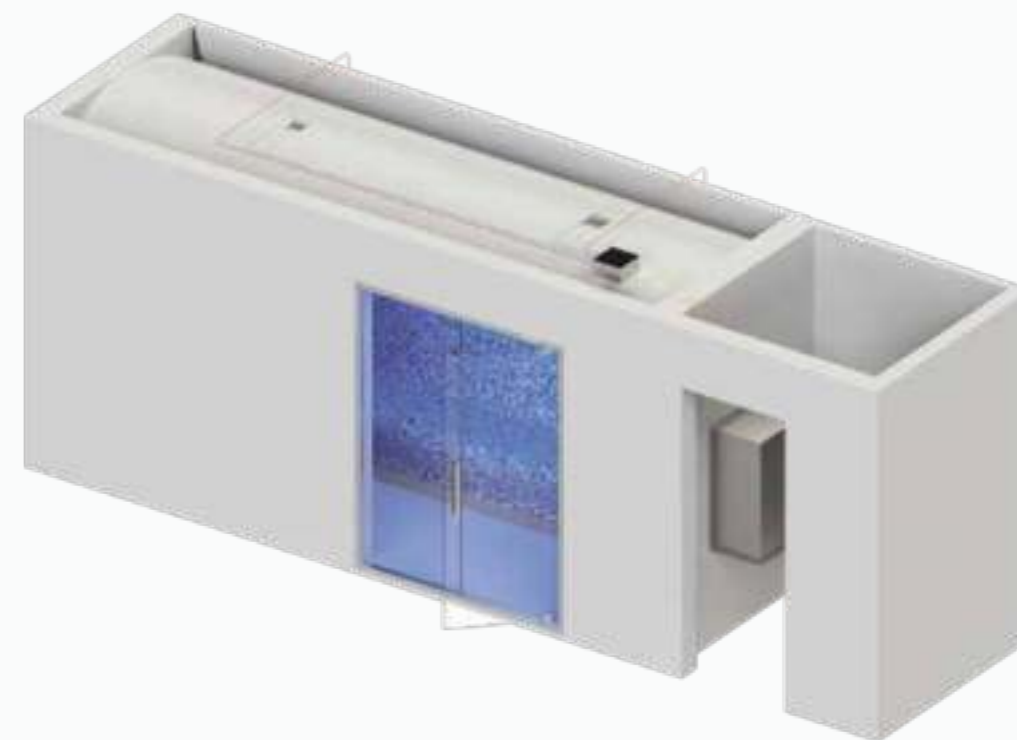

## Strutture in eps rasato

### Smooth EPS structures

#### ESEMPIO DI STRUTTURE

Lo spazio richiesto: Sv Steam è in grado di soddisfare tutti gli ambienti.

#### FRAMEWORK

Space needing: Steam generator suitable all the ambiances.

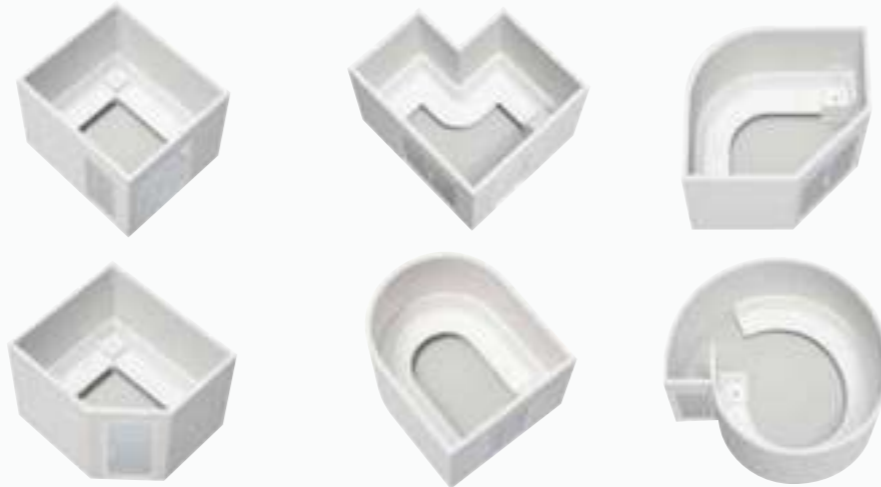

#### SOFFITTO

Evita l'effetto pioggia quando il vapore si condensa.  
Se la scelta ricade sul soffitto spiovente la pendenza deve essere almeno del 15%.

#### CEILING

These three shapes avoid the rain effect when steam condenses.  
In the case of the steep roof, the pitch should be at least 15%.



Volta a botte.  
Barrel vaulted ceiling.

Soffitto inclinato.  
Sloping ceiling.

Volta a crociera.  
Cross vault ceiling.

#### SEDUTE

Sedute a muro rivestibili (su misura).

#### SEATS

Seats on wall coverable seat (custom made size).



Seduta lineare con schienale.  
Linear seat with backrest.



Seduta ad angolo con schienale.  
Corner installation seat with backrest.



Seduta curva con schienale.  
Curved seat with backrest.



Seduta lineare senza schienale.  
Linear seat without backrest.



Seduta ad angolo senza schienale.  
Corner installation seat without backrest.



Seduta curva senza schienale.  
Curved seat without backrest.



Seduta lineare con schienale.  
Linear seat with backrest.



Seduta ad angolo con schienale.  
Corner installation seat with backrest.



Angolo lavabo con schienale.  
Sink with backrest.



Seduta lineare senza schienale.  
Linear seat without backrest.



Seduta ad angolo senza schienale.  
Corner installation seat without backrest.



Angolo lavabo senza schienale.  
Sink without backrest.



Erogatore di vapore.  
Steam outlet.

## Porte e vetrate con tenuta vapore

### Steam seal doors and windows

#### MODELLO SV STEAM

Componenti fondamentali per garantire il corretto funzionamento del bagno di vapore. Le porte e gli elementi fissi, sono in cristallo temperato da 8 mm espressamente creati per assolvere la funzione di tenuta del vapore ed evitare l'entrata di aria fredda.

Disponibili su misura.

#### SV STEAM MODEL

Fundamental components to preserve the proper function of the Turkish bath. Doors and fixed elements, in crystal glass 8 mm thick are specially designed to perform steam keeping and avoid fresh air incoming.

Available custom made size.



Porta  
Door



Porta con fisso  
Door + fixed element



Elemento fisso  
Fixed element



Porta senza profilo  
Door without profile



Porta con fisso senza profilo  
Door + fixed element without profile



Elemento fisso senza profilo  
Fixed element without profile

## Accessori

### Accessories

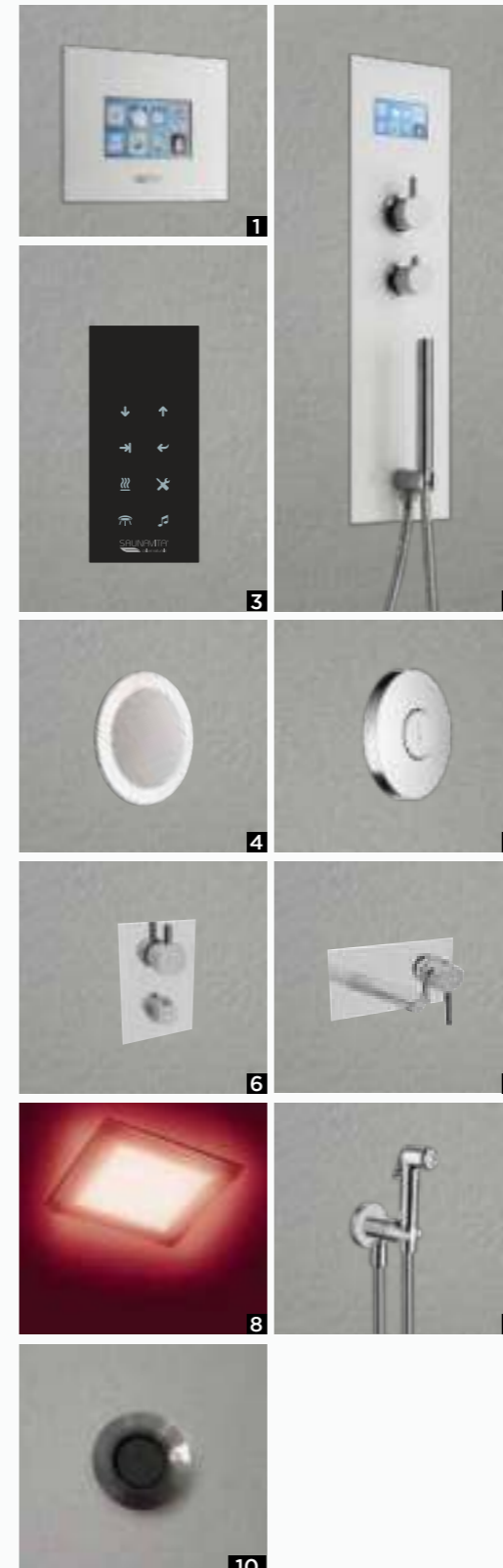

1. Tastiera Touch screen in cristallo con display LCD da 4.3" grafico a colori.
2. Tastiera Touch screen in cristallo con display LCD da 4.3" grafico a colori, completa di rubinetteria termostatica 3 vie e doccetta finitura cromo.
3. Tastiera capacitiva in cristallo nero con display Oled.
4. Sistema audio dotato di casse per la diffusione del suono e uscita USB per la connessione dei dispositivi audio.
5. Body Jet ad incasso in ABS cromato.
6. Miscelatore monocomando a 3 vie.
7. Miscelatore monocomando con bocca di erogazione.
8. Faro luce e cromoterapia in acciaio verniciato nero e cristallo.
9. Flessibile + doccino con rubinetto apertura/chiusura in finitura cromo.
10. Faretto ad incasso a LED luce bianca in acciaio Inox.
11. Soffione ad incasso in finitura acciaio.
12. Soffione con cromoterapia ad incasso in finitura acciaio.
13. Cascata lama ad incasso in finitura acciaio.

1. Crystal touch screen with colour LCD display 4.3".
2. Crystal touch screen with colour LCD display 4.3", with 3 ways thermostatic tap and handshower chrome finishing.
3. Black crystal touch screen with Oled display.
4. Sound system with speakers and USB output for the connection of audio devices.
5. Body Jet encased in ABS Chrome.
6. Single-lever 3-way mixer
7. Single-lever mixer with spout
8. Light and Chromotherapy light house in black and crystal painted steel.
9. Hose + Handheld shower head with opening/closing tap in chrome finish.
10. Encased white Light led spot in stainless steel.
11. Encased head-shower in steel finish.
12. Encased head-shower with chrome-therapy with steel finish.
13. Encased Water blade cascade in steel finishing.



# HAMMAM

---

**Generatori di vapore**  
*Steam generator*

**Linea Rigenera** <sup>204</sup>

**Kit coibentazione** <sup>221</sup>  
*Insulation kit*

**Porte e vetrate con tenuta vapore** <sup>221</sup>  
*Steam seal doors and windows*

**G-Steam + Gemini** <sup>224</sup>

**Gemini** <sup>234</sup>

# CONSIGLI PER L'HAMMAM

*Turkish bath tips*



**Nell'Hamam si crea l'equilibrio perfetto tra calore e vapore per stimolare un'azione rilassante e depurativa sull'organismo. Il bagno turco risulta ancora più efficace quando è abbinato alla cromoterapia e all'aromaterapia.**

*Inside Hammam the perfect balance between heat and steam is created to stimulate a relaxing and purifying action on the body. The turkish bath is still there more effective when combined with chromotherapy and aromatherapy.*

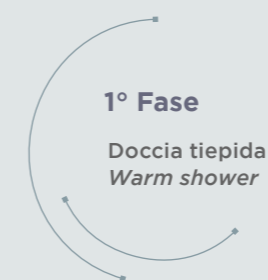

Prima di entrare fai una doccia tiepida e frizioni la pelle con un guanto di crine, per prepararla al calore. Puoi bere una tisana calda per favorire la sudorazione.

*Take a warm shower first and rub your skin with a horsehair glove to prepare it for the heat. Drinking cup of hot herbal tea can promote transpiration.*



Entra nel bagno turco nudo o coperto da un asciugamano e assumi una posizione comoda e rilassante. È consigliabile una permanenza tra i 10 e i 20 minuti.

*Enter the Turkish bath naked or wrapped in a towel and take a comfortable and relaxing position. You can stay for 10 to 20 minutes.*



Puoi aumentare i benefici dell'hammam diffondendo essenze per l'aromaterapia tramite l'erogatore di vapore e respirando a fondo e regolarmente.

*You can enhance the benefits of a Turkish bath by diffusing aromatherapy essences and breathing in deeply and regularly.*



Una volta uscito dall'hammam, fai una doccia fresca, asciugati e rimani sdraiato per almeno 20 minuti. Ricordati di bere dell'acqua per reintegrare i liquidi persi con la sudorazione.

*After the Turkish bath, take a cool shower, dry yourself up, and lie down for at least 20 minutes. You will lose lots of fluid through transpiration, so make sure to drink plenty of water.*

# LINEA RIGENERA

collection

Un concentrato di tecnologia e design d'avanguardia caratterizzano la linea Rigenera. Essenziale colonna multifunzione con generatore di vapore per bagno turco.

*A combination of technology and innovative design characterize the line Rigenera. Essential multifunction column with steam generator and turkish bath.*

**Cura estetica ed attenzione alla funzionalità hanno dato vita a Rigenera.**

*Aesthetic care and attention to functionality gave origin to our steam column Rigenera.*





# Rigenera<sup>200</sup>

Incasso in Cristallo  
*Built-in glass*

LINEA RIGENERA | collection



La tastiera, integrata nel cristallo, gestisce tutte le funzioni: bagno turco, cromoterapia e sistema audio con bluetooth.

*Thanks to built in crystal glass display panel it's possible to control every function: steam generator, colour therapy and bluetooth.*

**Erogatore di vapore con aromaterapia**  
*Steam dispenser with aromatherapy*



Un erogatore in acciaio alla base della colonna diffonde vapore nella cabina doccia, trasformandola in un bagno turco.

*Steel dispenser at the base of the column spreads steam into the shower cubicle, turning it into a Turkish bath.*

## Rigenera<sup>200</sup>

La colonna doccia multifunzione in cristallo con rubinetteria nera arreda con stile uno spazio doccia-bagno turco. Alla fine di una giornata lavorativa o dopo lo sport, è la soluzione ideale per recuperare la forma psicofisica in un ambiente completamente dedicato al proprio benessere. La cromoterapia integrata massimizza i benefici della doccia o del bagno turco: attraverso i colori caldi favorisce il buon umore e infonde energia positiva e con i colori freddi rilassa corpo e mente.

*The multifunctional crystal shower column with black taps furnishes a shower-Turkish bath space with style. At the end of a working day or after sport it is the ideal solution to recover your psychophysical shape in an environment entirely dedicated to your well-being. The integrated chromotherapy increases the benefits of the shower or Turkish bath: through warm colours it promotes a good mood and infuses positive energy and with cold colours it relaxes body and mind.*

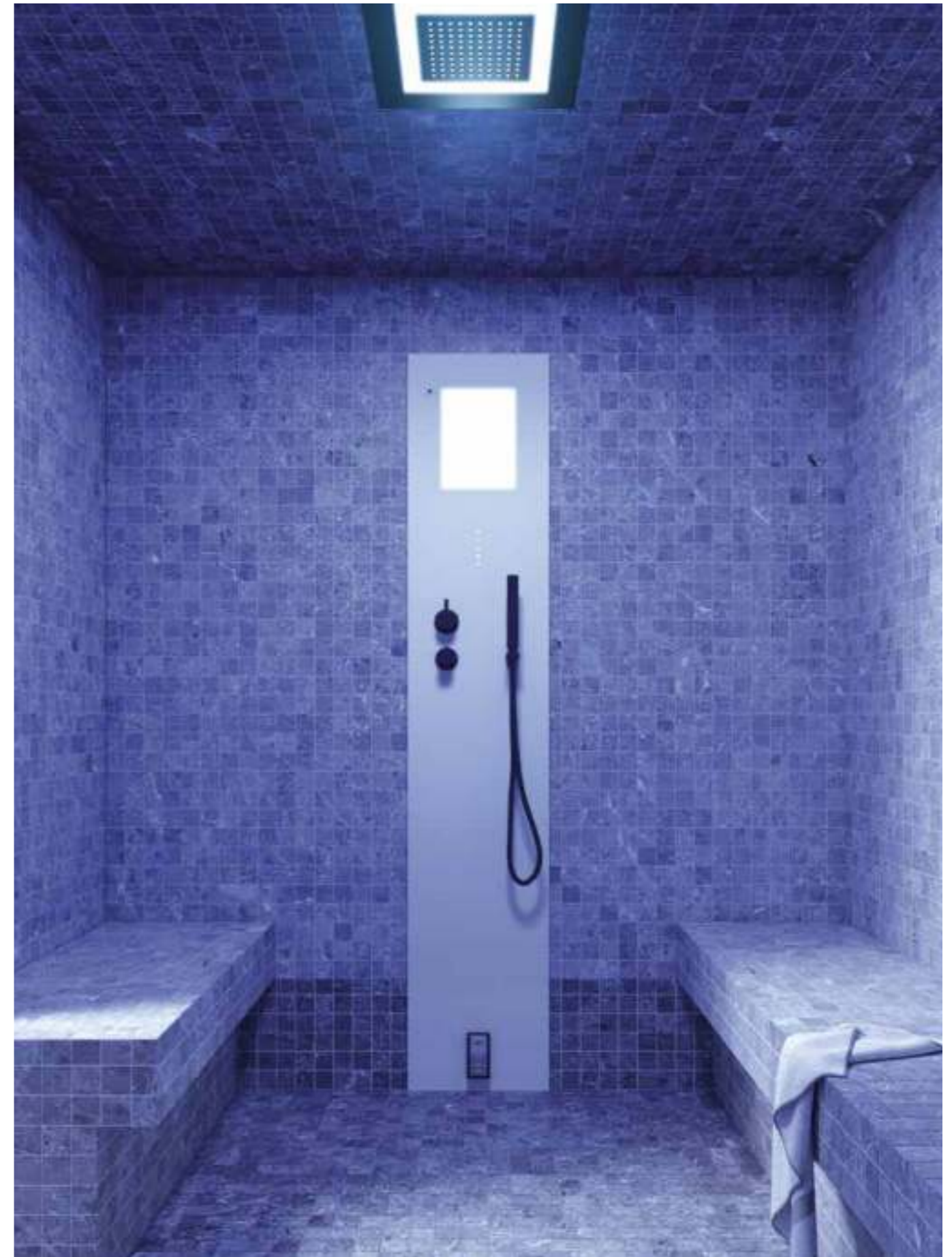

## Rigenera 200 S

Incasso in Cristallo senza rubinetteria  
*Built-in glass without tap*



## Rigenera 200

Incasso in solid surface  
*Built-in solid surface*



## Rigenera 200

Esterna Solid Surface con soffione  
*External Solid Surface with shower head*



## Rigenera 200

Esterna Solid Surface senza soffione  
*External Solid Surface without shower head*



## Rigenera + Gemini

Grazie a Gemini è possibile progettare ambienti per il bagno turco con dimensioni fino a 190x120 cm (h. 214 cm). Le pareti con cristallo temperato da 8 mm. Il tetto coibentato è disponibile in più varianti:

- con o senza soffione;
- con soffione e cromoterapia;

Gemini può essere installato con tutti i piatti doccia Hafro, o direttamente sul pavimento. Con un unico prodotto potrai avere una stanza hammam di immediato utilizzo senza opere di muratura ed economicamente vantaggiosa. Gemini si combina perfettamente con qualsiasi generatore di vapore.

*Thanks to Gemini it is possible to set your own Turkish bath with dimensions up to 190x120 cm (h. 214 cm). Tempered crystal glass wall is 8 mm thick. The insulated roof is available in several variants:*

- with or without showerhead;*
- with showerhead and chromotherapy;*

*Gemini can be installed with all Hafro shower trays, or directly on the floor. With a single product you can have a hammam room of immediate use without masonry works and economically advantageous. Gemini combines perfectly with any steam generator.*



## Rigenera 200

Incasso in cristallo  
*Built-in Rigenera 200 glass*



Cromoterapia  
*Chromotherapy*

Doccetta raining  
*"Raining" hand shower*

Miscelatore termostatico  
*Thermostatic tap*

Potenza generatore di vapore: 3-4-5-6 kW,  
consente di allestire Hammam fino a 6,5 m<sup>3</sup>  
*Steam generator power: 3-4-5-6 kW,  
means Hammam till 6.5 m<sup>3</sup>*

Sistema audio con Bluetooth  
*Bluetooth Sound System*

Erogatore di vapore  
*Steam dispenser*

### DIMENSIONI

38x10,2x198 H  
kW 6 - max 6,5 m<sup>3</sup>  
kW 5 - max 5,5 m<sup>3</sup>  
kW 4 - max 4,5 m<sup>3</sup>  
kW 3 - max 3,5 m<sup>3</sup>

### CARATTERISTICHE

Generatore di vapore per bagno turco multiclimate  
Sistema di decalcificazione per caldaia  
Miscelatore termostatico a 3 vie (di cui 1 disponibile per eventuale accessorio soffione)  
Doccetta raining  
Erogatore vapore con dispenser per aromaterapia  
Cromoterapia  
Materiale di costruzione: acciaio satinato e frontale in Cristallo bianco

### MEASUREMENT

38x10.2x198 H  
kW 6 - max 6.5 m<sup>3</sup>  
kW 5 - max 5.5 m<sup>3</sup>  
kW 4 - max 4.5 m<sup>3</sup>  
kW 3 - max 3.5 m<sup>3</sup>

### SPECIFICATIONS

Steam generator for Multiclimate Turkish baths  
Boiler descaling system  
3-way thermostatic mixer (of which 1 available for optional shower head accessory)  
Rainfall handheld shower head  
Steam dispenser with aromatherapy diffuser  
Chromotherapy  
Construction material: satin steel with white glass front

### INSTALLAZIONE

Incasso

### ACCESSORI

Audio con Bluetooth

### INSTALLATION

Built-in

### ACCESSORIES

Sound with Bluetooth

## Rigenera 200 S

Incasso in cristallo senza rubinetteria  
*Built-in rigenera 200 s glass without tap*



Cromoterapia  
*Chromotherapy*

Potenza generatore di vapore: 3-4-5-6 kW,  
consente di allestire Hammam fino a 6,5 m<sup>3</sup>  
*Steam generator power: 3-4-5-6 kW,  
means Hammam till 6.5 m<sup>3</sup>*

Sistema audio con Bluetooth  
*Bluetooth Sound System*

Erogatore di vapore  
*Steam dispenser*

### DIMENSIONI

38x10,2x198 H  
kW 6 - max 6,5 m<sup>3</sup>  
kW 5 - max 5,5 m<sup>3</sup>  
kW 4 - max 4,5 m<sup>3</sup>  
kW 3 - max 3,5 m<sup>3</sup>

### CARATTERISTICHE

Generatore di vapore per bagno turco multiclimate  
Sistema di decalcificazione per caldaia  
Erogatore vapore con dispenser per aromaterapia  
Cromoterapia  
Materiale di costruzione: acciaio satinato e frontale in Cristallo bianco

### MEASUREMENT

38x10.2x198 H  
kW 6 - max 6.5 m<sup>3</sup>  
kW 5 - max 5.5 m<sup>3</sup>  
kW 4 - max 4.5 m<sup>3</sup>  
kW 3 - max 3.5 m<sup>3</sup>

### SPECIFICATIONS

Steam generator for Multiclimate Turkish baths  
Boiler descaling system  
Steam dispenser with aromatherapy diffuser  
Chromotherapy  
Construction material: satin steel with white glass front

### INSTALLAZIONE

Incasso

### ACCESSORI

Audio con Bluetooth

### INSTALLATION

Built-in

### ACCESSORIES

Sound with Bluetooth

## Rigenera 200

Incasso in Solid Surface  
*Built-in Rigenera 200 Solid Surface*



### DIMENSIONI

38x10,2x198 H  
kW 4 - max 4,5 m<sup>3</sup>  
kW 3 - max 3,5 m<sup>3</sup>

### CARATTERISTICHE

Generatore di vapore per bagno turco multiclimate  
Sistema di decalcificazione per caldaia  
Miscelatore termostatico a 5 vie (di cui 1 disponibile per eventuale accessorio soffione)  
Doccetta raining  
Cascata a velo  
Nr. 3 soffioni verticali  
Erogatore vapore con dispenser per aromaterapia  
Cromoterapia  
Materiale di costruzione: acciaio satinato e frontale in Solid Surface

### INSTALLAZIONE

Incasso

### MEASUREMENT

38x10.2x198 H  
kW 4 - max 4.5 m<sup>3</sup>  
kW 3 - max 3.5 m<sup>3</sup>

### SPECIFICATIONS

Steam generator for Multiclimate Turkish baths  
Boiler descaling system  
5-way thermostatic mixer (of which 1 available for optional shower head accessory)  
Rainfall handheld shower head  
Water blade cascade  
3 vertical jets  
Steam dispenser with aromatherapy diffuser  
Chromotherapy  
Construction material: satin steel with Solid Surface front

### INSTALLATION

Built-in

## Rigenera 200

Solid Surface senza soffione  
*Solid Surface without shower head*

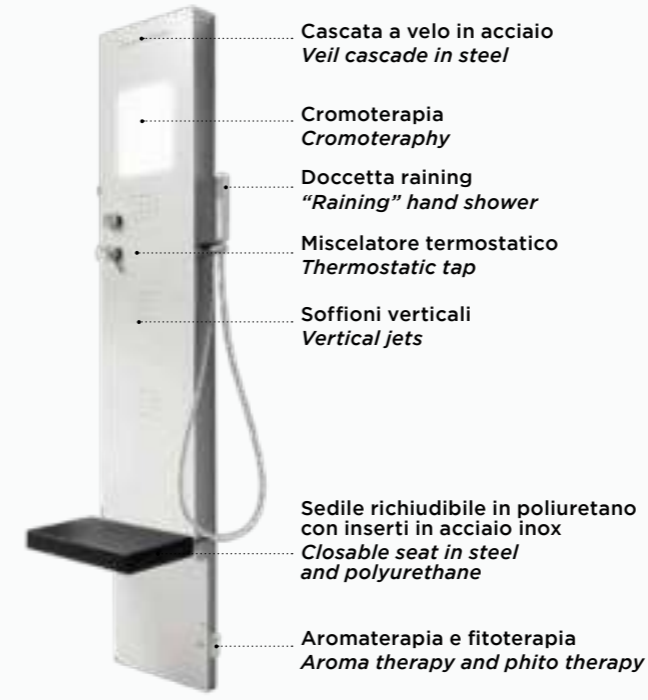

### DIMENSIONI

35x11x199 H  
kW 4 - max 4,5 m<sup>3</sup>  
kW 3 - max 3,5 m<sup>3</sup>

### CARATTERISTICHE

Generatore di vapore da 3/4 kW per bagno turco multiclimate  
Sistema di decalcificazione per caldaia  
Miscelatore termostatico (di cui 1 disponibile per eventuale accessorio soffione)  
Doccetta  
Cascata a velo  
Nr. 3 soffioni verticali  
Sedile richiudibile in acciaio e poliuretano - colore Antracite  
Erogatore vapore con dispenser per aromaterapia e fitoterapia  
Cromoterapia  
Tastiera touch  
Materiale di costruzione: acciaio satinato e frontale in Solid Surface

### FINITURA

Solid Surface

### MEASUREMENT

35x11x199 H  
kW 4 - max 4.5 m<sup>3</sup>  
kW 3 - max 3.5 m<sup>3</sup>

### SPECIFICATIONS

4 kW steam generator for Multiclimate Turkish baths  
Boiler descaling system  
Thermostatic mixer (of which 1 available for optional shower head accessory)  
Handheld shower head  
Water blade cascade  
3 vertical jets  
Steel and polyurethane foldable seat - Antracite colour  
Steam dispenser with aromatherapy and phytotherapy diffuser  
Chromotherapy  
Touch keypad  
Construction material: satin steel with Solid Surface front

### FINISH

Solid Surface

## Rigenera<sup>200</sup>

Solid Surface con soffione  
*Solid Surface with shower head*

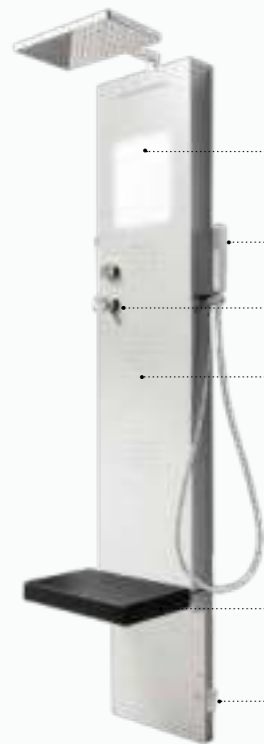

Cromoterapia  
*Cromotherapy*

Doccetta raining  
*"Raining" hand shower*

Miscelatore termostatico  
*Thermostatic tap*

Soffioni verticali  
*Vertical jets*

Sedile richiudibile in poliuretano  
con inserti in acciaio inox  
*Closable seat in steel  
and polyurethane*

Aromaterapia e fitoterapia  
*Aroma therapy and phito therapy*

### DIMENSIONI

35x11x199 H  
kW 4 - max 4,5 m<sup>3</sup>  
kW 3 - max 3,5 m<sup>3</sup>

### CARATTERISTICHE

Generatore di vapore da 3/4 kW  
per bagno turco multiclina  
Sistema di decalcificazione per caldaia  
Miscelatore termostatico 5 vie  
Doccetta  
Cascata a velo  
Nr. 3 soffioni verticali  
Sedile richiudibile in acciaio e  
poliuretano - colore Antracite  
Erogatore vapore con dispenser  
per aromaterapia e fitoterapia  
Cromoterapia  
Tastiera touch  
Materiale di costruzione: acciaio satinato  
e frontale in Solid Surface

### FINITURA

Solid Surface

### MEASUREMENT

35x11x199 H  
kW 4 - max 4.5 m<sup>3</sup>  
kW 3 - max 3.5 m<sup>3</sup>

### SPECIFICATIONS

3/4 kW steam generator for Multiclina  
Turkish baths  
Boiler descaling system  
5-way thermostatic mixer  
Handheld shower head  
Water blade cascade  
3 vertical jets  
Steel and polyurethane foldable seat -  
Antracite colour  
Steam dispenser with aromatherapy  
and phytotherapy diffuser  
Chromotherapy  
Touch keypad  
Construction material: satin steel  
with Solid Surface front

### FINISH

Solid Surface

## Kit coibentazione *Insulation kit*

### LA COIBENTAZIONE: PIÙ RESA, MENO CONSUMI

Coibentare le pareti ed il soffitto del vano assicura una resa migliore ed un minor consumo di energia, evitando dispersione di calore. Hafro comprende un kit di pannelli completamente isolanti da 60x125 cm, spessi 3 cm, rivestiti in malta cementizia. Il rivestimento di finitura, mosaico o piastrelle, e le eventuali opere in muratura o cartongesso richieste, rientrano nell'ambito della personalizzazione dell'ambiente.

Kit coibentazione con:

- pannelli isolanti da 60x125 cm
- finitura per ricoprire: mosaico o piastrelle.

### THE INSULATION: GREATER PERFORMANCE, LOWER CONSUMPTION

Insulating the walls and the ceiling of the room ensures greater output and lower energy consumption, by avoiding heat dispersal. Hafro includes a kit of 60x125 cm, 3 cm thick panels, which insulate completely and are covered in cement mortar. Their finishings, in mosaic or tiles, and any brickwork or plasterboarding can be freely personalised by the client.

Insulation kit with:

- insulating panels 60x125 cms
- finish to cover: mosaic or tiles.

### LO SPAZIO RICHiesto

Lunghezza e larghezza possono variare, sapendo che un generatore di vapore a seconda della potenza può soddisfare ambienti di volumi differenti. Il flusso di vapore sarà così sempre bilanciato, con temperatura e umidità uniformi.

### SPACE NEEDING

Length and width may vary, steam generator selection can satisfy space of different volumes. Steam will always be equalized, temperature and damp will always be uniform.

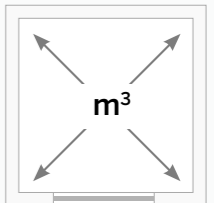

## Porte e vetrate con tenuta vapore *Steam seal doors and windows*

### PORTE E VETRATE

Sono un elemento fondamentale perché devono evitare nella maniera più assoluta l'entrata d'aria e la fuoriuscita di vapore, assicurando così un perfetto isolamento dell'ambiente.

Porte e vetrate, in cristallo temperato da 6 mm, sono state realizzate espressamente per questa funzione, con un design essenziale e pulito che ne facilita l'inserimento in ogni tipo di locale.

Disponibili su misura.

### DOOR AND WINDOWS

These are fundamental element since they prevent air from getting in and steam from getting out, therefore completing the insulation of the room. 6 mm tempered glass doors and panels have been designed specifically to this purpose, with an essential and clean design, which enables them to be easily matched with all types of bathroom.

Available custom made size.



Porta singola  
(68 min / 72 max cm)

Di facile e sicuro montaggio, esteticamente piacevole, con eleganti profili in acciaio, maniglia sagomata e una larghezza che può variare da 68 a 72 cm.

Single door  
(68 min / 72 max cm)

This is the simplest way to create a functional entrance in technical terms, which is easy and safe to assemble and is aesthetically pleasing, with elegant profiles made of stainless steel, a shaped handle and widths that can vary from 68 to 72 cm.



Lato fisso  
(68 min / 72 max cm)

Le stesse caratteristiche fisiche e lo stesso design della porta si ritrovano nel lato fisso da aggiungere, una parete vetrata perfettamente isolante che allarga il senso dello spazio e dà all'ambiente un respiro maggiore.

Fixed sidewalls  
(68 min / 72 max cm)

The same physical characteristics and the same design as the door are to be found in the fixed sidewall, a perfectly insulating glass panel that enlarges the sense of space and gives the setting greater breathing space.



Vetrata  
(0 min / 80-100-110 -120 max cm)

Nei bagni turchi di volume più grande, l'utilizzo della vetrata isolante, realizzata con gli stessi criteri tecnici ed estetici della porta, offre una variante progettuale di grande interesse, dando la possibilità di creare un bagno turco con pareti trasparenti

Glass door  
(0 min / 80-100-110 -120 max cm)

In the larger-sized Turkish baths, the use of insulating glass doors made with the same technical and aesthetic criteria as the door offers a very interesting planning variant, offering the possibility of creating a Turkish bath with transparent walls.



## Accessori

### Accessories

#### LAVANDINI

Per completare l'arredamento dell'ambiente si può installare un piccolo e grazioso lavamani in Solid Surface, bianco o nero, completo di miscelatore, sifone e piletta, per avere sempre a disposizione una gradevole fonte d'acqua fresca. La forma può essere semicircolare o rettangolare.

#### WASHBASIN

To complete the setting, a small and stylish Solid Surface basin, white or black, can be installed equipped with a mixer, siphon and plug, to get a refreshing supply of water at any time. It can be semi-circular or rectangular.



#### SOFFIONI

Soffioni ad incasso con controcassa in finitura acciaio.

#### SHOWER HEADS

Built-in shower heads with second steel casing.



Soffione ad incasso  
Built-in shower head  
30x30 / 38x38 cm

Soffione ad incasso  
con cromoterapia  
Built-in shower head  
with chromotherapy  
38x38 cm

#### PANCHE E ACCESSORI

1. Seduta a muro ribaltabile 36x30x8 H.
2. Sgabello in acrilico 40x24,5x44 H.
3. Sgabello in acciaio e Corian® 38x27,8x44 H.
4. Sgabelli in Solid Surface bianco 42x25x44 H e 37,5x25x41,5 H.
5. Panca 100x34x45 H.
6. Luce e cromoterapia.
7. Miscelatore monocomando con bocca di erogazione.
8. Miscelatore monocomando a 3 vie.

#### BENCHES AND ACCESSORIES

1. Wall-mount folding seat 36x30x8 H.
2. Acrylic stool 40x24,5x44 H.
3. Steel and Corian® stool 38x27,8x44 H.
4. Solid surface stool 42x25x44 H and 37,5x25x41,5 H.
5. Bench 100x34x45 H.
6. Chromotherapy and light.
7. Single lever mixer tap with spout.
8. Three-way single lever mixer tap.



# G-STEAM + GEMINI

collection

G-Steam è il prodotto ideale per chi vuole realizzare un hammam all'interno del proprio bagno senza eseguire lavori di muratura. La colonna può essere abbinata unicamente al box doccia Gemini con chiusura battente, scorrevole o pivotante e con uno spessore di soli 3,8 cm non necessita di incasso nel muro. Il programma G-Steam+Gemini unisce design, tecnologia e funzionalità in un unico prodotto.

*G-Steam is the ideal product for those who want to place hammam inside their bathroom without performing masonry work. The column can only be matched to the Gemini shower cabin with hinged, sliding or pivoting doors and thanks to its thickness of only 3.8 cm it does not need to be recessed into the wall. The G-Steam + Gemini program combines design, technology and functionality in a single product.*

**La nuova colonna doccia con  
generatore di vapore abbinabile  
al box doccia Gemini.**

*The new shower column with  
steam generator can be matched with  
the Gemini shower box.*



## Generatore di vapore G-Steam

*G-Steam generator*



**G-Steam**



## Box doccia Gemini

*Gemini shower cabin*



Gemini 5 scorrevole  
*sliding doors*



Gemini 5 battente  
*hinged doors*



Gemini 5 pivottante  
*pivoting doors*



## Piatti doccia (catalogo shower)

*Shower trays (shower catalogue)*

## Modelli G-Steam

*G-Steam models*

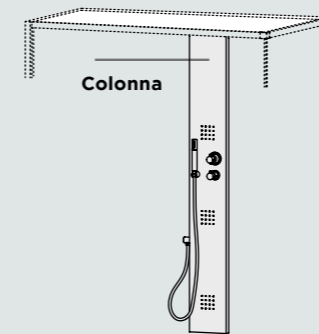

### G-steam<sup>BASE</sup>

Colonna doccia in acciaio completa di 3 body jet, rubinetteria termostatica e doccia.

*Base steel shower column complete with 3 body jets, thermostatic taps and handheld shower head.*

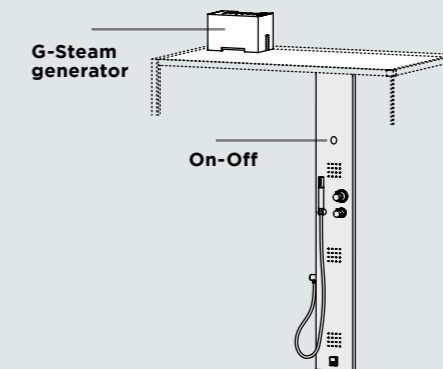

### G-steam<sup>ON - OFF</sup>

Unisce alla colonna doccia il generatore di vapore per bagno turco, da posizionare sopra il tetto della cabina doccia, e un semplice comando meccanico on/off per l'accensione/spengimento del generatore di vapore.

*On/Off combines a Turkish bath steam generator to the shower column, to be positioned over the shower cabin roof, with a simple mechanical on/off control to activate/deactivate the steam generator.*

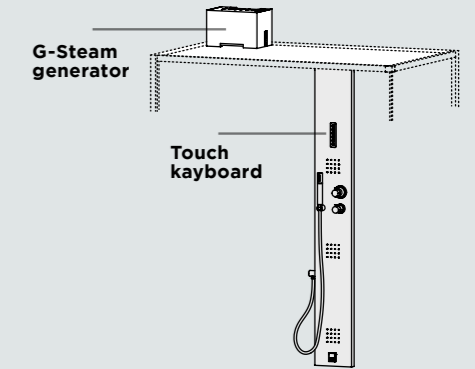

### G-steam<sup>TOP</sup>

Unisce alla colonna doccia il generatore di vapore per bagno turco multiclimate, con comandi a tastiera digitale touch, sensore di temperatura e possibilità di installare il sistema per la cromoterapia e l'accessorio Bluetooth.

*Top combines a Multiclimate system Turkish bath steam generator to the shower column, with digital display panels, temperature sensor and the possibility of installing a colour therapy system and Bluetooth accessory.*

## Plus



**Senza opere murarie**  
*No masonry works*



**Pronto all'uso**  
*Ready to use*



**Salva spazio**  
*Space saving*

## G-Steam<sup>TOP</sup>

+ Gemini



**HAFRO**  
acqua, per piacere

### CARATTERISTICHE

Gemini 5 pivottante SX 140x90 cm  
soffione 26x26 cm  
colonna G-Steam on-off  
piatto Tecnotek Flat H. 140x90 cm Bianco

### SPECIFICATIONS

Gemini 5 pivoting LH 140x90 cm  
Showerhead 26x26 cm  
G-Steam on-off column  
White Tecnotek Flat H. 140x90 cm Shower tray

**G-steam** TOP



**G-steam** BASE



**G-steam** ON - OFF



**Generatore ed erogatore di vapore  
solo per versione G-Steam Top e On-Off**  
*Steam generator only for  
G-Steam Top and On-Off versions*



## G Steam <sup>BASE</sup>



### G-Steam Base colonna doccia

**DIMENSIONI**  
24x3,8x190 H cm

**CARATTERISTICHE**  
Miscelatore termostatico  
a 3 vie (di cui 1 disponibile  
per soffione  
posizionato nel tetto)  
Doccetta  
3 soffioni verticali  
Materiale di costruzione  
acciaio inox lucido

### G-Steam Base shower column

**MEASUREMENT**  
24x3.8x190 H cm

**SPECIFICATIONS**  
3-way thermostatic mixer  
(of which 1 for the shower  
head positioned on the roof)  
Handheld shower head  
3 vertical jets  
Satin stainless steel  
construction material

## G Steam <sup>ON-OFF</sup>



### Colonna doccia con generatore di vapore

**DIMENSIONI**  
24x3,8x190 H cm  
4 kW - 4,5 m<sup>3</sup>  
3 kW - 3,5 m<sup>3</sup>  
2,5 kW - 3 m<sup>3</sup>

**Materiale di  
costruzione  
acciaio inox  
lucido**

**CARATTERISTICHE**  
Miscelatore termostatico  
a 3 vie (di cui 1 disponibile  
per soffione posizionato  
nel tetto)  
Doccetta  
3 soffioni verticali  
Erogatore di vapore  
in acciaio inox, con  
aromaterapia  
Generatore di vapore  
(da posizionare sopra  
il tetto) con cover di  
copertura  
Comando meccanico  
(on/off) per attivazione  
e spegnimento bagno  
turco

### Shower column with steam generator

**MEASUREMENT**  
24x3,8x190 H cm  
4 kW - 4,5 m<sup>3</sup>  
3 kW - 3,5 m<sup>3</sup>  
2,5 kW - 3 m<sup>3</sup>

**Materiale di  
costruzione  
acciaio inox  
lucido**

**SPECIFICATIONS**  
Miscelatore termostatico  
a 3 vie (di cui 1 disponibile  
per soffione posizionato  
nel tetto)  
Doccetta  
3 soffioni verticali  
Erogatore di vapore  
in acciaio inox, con  
aromaterapia  
Generatore di vapore  
(da posizionare sopra  
il tetto) con cover di  
copertura  
Comando meccanico  
(on/off) per attivazione  
e spegnimento bagno  
turco

## G Steam <sup>TOP</sup>



### Colonna con generatore di vapore e cromoterapia

**DIMENSIONI**  
24x3,8x190 H cm  
4 kW - 4,5 m<sup>3</sup>  
3 kW - 3,5 m<sup>3</sup>  
2,5 kW - 3 m<sup>3</sup>

**Materiale di  
costruzione  
acciaio inox  
lucido**

**CARATTERISTICHE**  
Miscelatore termostatico  
a 3 vie (di cui 1 disponibile  
per soffione posizionato  
nel tetto)  
Doccetta  
3 soffioni verticali  
Erogatore di vapore  
in acciaio inox, con  
aromaterapia  
Generatore di vapore  
(da posizionare sopra  
il tetto) con cover di  
copertura  
Bagno turco multiclimate  
Tastiera touch  
Sensore di temperatura  
Cromoterapia (solo per  
tetto con soffione  
in acciaio con  
cromoterapia 30x30 cm)

### Shower column with steam generator clour therapy

**MEASUREMENT**  
24x3,8x190 H cm  
4 kW - 4,5 m<sup>3</sup>  
3 kW - 3,5 m<sup>3</sup>  
2,5 kW - 3 m<sup>3</sup>

**Polished  
stainless steel  
construction  
material**

**SPECIFICATIONS**  
3-way thermostatic mixer  
(of which 1 for the shower  
head positioned on the roof)  
Handheld shower head  
3 vertical jets  
Stainless steel steam  
dispenser, with aromatherapy  
Steam generator (to be  
positioned over the roof)  
with coverage  
Multiclimate Turkish bath  
Touch keypad  
Temperature sensor  
Colour therapy (only for  
roofs with steel shower  
head with colour therapy  
30x30 cm)

### Generatore di vapore Steam generator



**33x22x20 H cm**

G-Steam è la nuova colonna  
doccia con generatore di vapore  
ideata dal reparto Ricerca e  
Sviluppo di Hafro.

*G-Steam is a new shower column  
with steam generator designed  
by the Hafro Research and  
Development department.*

# GEMINI

collection

*Gemini è la risposta più efficace al desiderio di un bagno turco che si inserisce perfettamente nel bagno di casa, da installare direttamente senza bisogno di opere particolari. Ma non solo, Gemini è anche una chiusura per semplici ambienti doccia, da personalizzare con piatti e colonne che soddisfano il proprio gusto estetico e le personali esigenze di relax quotidiano.*

Gemini is the most effective answer to the desire for a Turkish bath that fits perfectly in the bathroom of the house, to be installed directly without the need for special works. But not only, Gemini is also a closure for simple shower rooms, to be customized with shower tray and columns that satisfy their aesthetic taste and personal needs for daily relaxation.

**Box doccia con tetto per  
hammam o ambienti doccia.**

*The roof for hammams or  
shower rooms.*



## Gemini scorrevole

collection

Box doccia con tetto per hammam  
o ambienti doccia.

*Shower cabin with roof for hammam  
or shower rooms.*



L'anta scorrevole con sgancio rapido permette  
una pulizia accurata del piatto e dell'interno doccia.

*Sliding door with fast releasable system for a perfect  
cleaning of shower tray and inside glass.*

### CARATTERISTICHE

Gemini 5 scorrevole SX 150x100x214 H  
piatto Flat in Tecnotek H 2,5 - 150x100 cm

### SPECIFICATIONS

*Gemini 5 sliding doors left 150x100x214 H  
Flat in Tecnotek tray H 2,5 - 150x100 cm White*







## Gemini battente

collection

Box doccia con tetto per hammam  
o ambienti doccia.  
*Shower cabins with roof for hammam  
or shower rooms.*

### CARATTERISTICHE

Gemini 4 battente DX 150x100x214 H cm  
con soffione integrato 26x26 cm  
piatto Flat in Tecnotek H 2,5 - 150x100 cm Bianco

### SPECIFICATIONS

Gemini 4 hinged doors right 150x100x214 H cm  
with integrated shower head 26x26 cm  
Flat in Tecnotek tray H 2,5 - 150x100 cm White

## Gemini battente

*collection*



I profili sottili incorniciano i cristalli e valorizzano il design minimal della chiusura. L'essenzialità estetica è il punto in comune di tutte le versioni.

*The thin frame of the glasses enhance the minimal design of the shower cabins. The aesthetic essentiality is the common point of all the versions.*



Maniglia e cerniera condividono le stesse linee squadrate e permettono di aprire e chiudere l'anta battente agevolmente.

*Handle and hinge share the same squared lines and allow the hinged door to be opened and closed easily.*

## Gemini battente

collection

+ Rigenera 200

---

### CARATTERISTICHE

Rigenera 200  
Gemini battente 180x100x214 H

### SPECIFICATIONS

Rigenera 200  
Gemini hinged doors 180x100x214 H



## Gemini pivottante

collection

+ G-Steam <sup>BASE</sup>

Box doccia con tetto per hammam  
o ambienti doccia.

*Shower cabins with roof for hammam  
or shower rooms.*



Pivottante Gemini 5  
Gemini 5 pivoting

**GEROMIN**

Comp. Change

**HAFRO**  
acqua, per piacere

Vasca - Tub Mode

### CARATTERISTICHE

Gemini 5 pivottante DX 150x90x214 H  
con soffione integrato 26x26 cm  
Colonna G-Steam Base  
piatto Flat in Tecnotek H 2,5 - 150x100 cm

### SPECIFICATIONS

*Gemini 5 pivoting right 150x90x214 H  
with integrated shower head 26x26 cm  
G-Steam Base cloumn  
Flat in Tecnotek tray H 2,5 - 150x100 cm White*



## Tetto Gemini

### Gemini roof



Tetto semplice.  
Simple roof.



Tetto con soffione.  
Built-in roof headshower.



Tetto con soffione e cromoterapia.  
Built-in roof headshower and colour therapy.

Si può scegliere il tetto in versione semplice, oppure con accessorio:  
- soffione 26 x 26 cm;  
- soffione con cromoterapia 30 x 30 per programma Rigenera o G-Steam.

You can choose the roof in simple version, or with accessory:  
- 26 x 26 cm shower head;  
- 30 x 30 chromotherapy shower head for the Rigenera or G-Steam program.

## Accessori

### Accessories

#### PANCHE E ACCESSORI

1. Seduta a muro ribaltabile 36x30x8 H.
2. Sgabello in acrilico 40x24,5x44 H.
3. Sgabello in acciaio e Corian® 38x27,8x44 H.
4. Sgabelli in Solid Surface bianco 42x25x44 H e 37,5x25x41,5 H.

#### BENCHES AND ACCESSORIES

1. Wall-mount folding seat 36x30x8 H.
2. Acrylic stool 40x24.5x44 H.
3. Steel and Corian® stool 38x27.8x44 H.
4. Solid surface stool 42x25x44 H and 37.5x25x41.5 H.



## Installazione Gemini

### Gemini installation

### Angolo Corner

#### Gemini 4 \_ Porta laterale Side door



##### Scorrevole Sliding doors

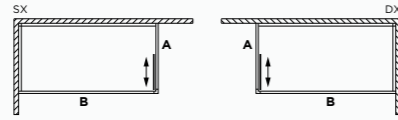

##### Battente senza profilo inferiore Hinged doors without lower profile

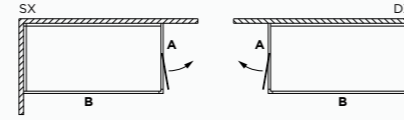

##### Pivottante con profilo inferiore Pivoting with lower profile

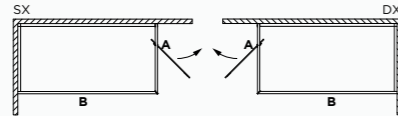

#### Gemini 5 \_ Porta frontale Front door



##### Scorrevole Sliding doors

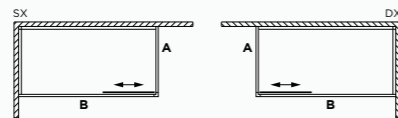

##### Battente senza profilo inferiore Hinged doors without lower profile

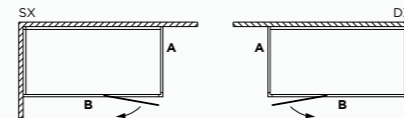

##### Pivottante con profilo inferiore Pivoting with lower profile

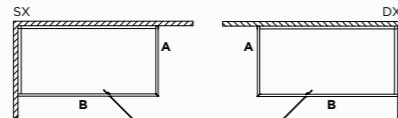

### Parete Wall

#### Gemini 6 \_ Porta laterale Side door



##### Scorrevole Sliding doors

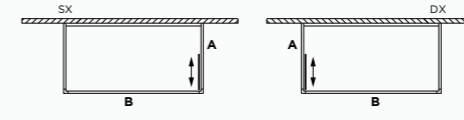

##### Battente senza profilo inferiore Hinged doors without lower profile

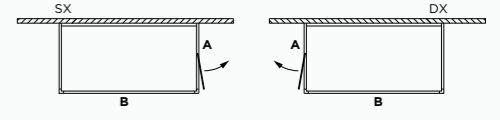

##### Pivottante con profilo inferiore Pivoting with lower profile

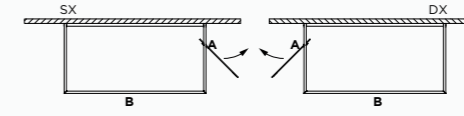

#### Gemini 7 \_ Porta frontale Front door



##### Scorrevole Sliding doors

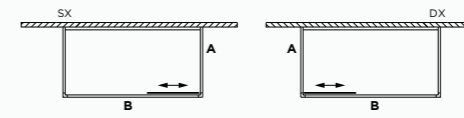

##### Battente senza profilo inferiore Hinged doors without lower profile

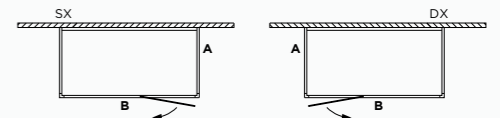

##### Pivottante con profilo inferiore Pivoting with lower profile

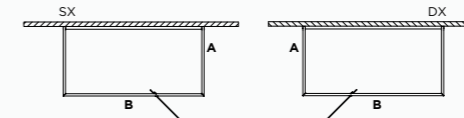

### Nicchia Niche

#### Gemini 8 \_



##### Scorrevole Sliding doors

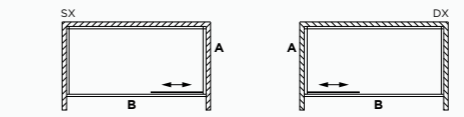

##### Battente senza profilo inferiore Hinged doors without lower profile

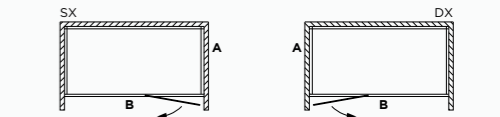

##### Pivottante con profilo inferiore Pivoting with lower profile

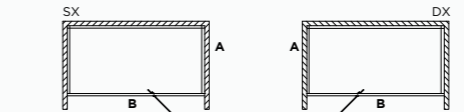



# BOX DOCCIA MULTIFUNZIONE

MULTIFUNCTION  
SHOWER CABINS

---

**Tempo** <sup>254</sup>

**Soul** <sup>262</sup>

**Sound** <sup>268</sup>

## BOX DOCCIA CON HAMMAM E IDROMASSAGGIO

*Shower cabins with  
turkish bath and hydromassage*

Le cabine doccia con bagno turco e idromassaggio Hafro sono un angolo attrezzato per un benessere "prêt-à-porter", da vivere quando si vuole nella comodità della propria casa. Oltre al soffione centrale integrato al tetto dei box doccia, da cui scende un vigoroso getto d'acqua, le pareti delle cabine doccia multifunzione sono dotate di getti per l'idromassaggio verticale: l'acqua esce nebulizzata, pulsata e a pioggia. In più, nella doccia multifunzione ci si può godere l'effetto della cromoterapia.

*Hafro shower cabins with Turkish bath and whirlpool are a fully equipped, ready-to-use wellness area that you can make use of whenever you want from the comfort of your own home. In addition to a central shower head built into the cabins roof, from which a strong jet of water comes down, the walls of the multifunction shower cabins are equipped with vertical whirlpool jets: water comes out in spray, pulsed, and rain. Users can also enjoy the effects of colour therapy in the multifunction cabin.*

## BOX DOCCIA CON IDROMASSAGGIO E HAMMAM

*Shower cubicles with  
hydromassage and turkish bath*



### Una doccia di vapore.

*A steam shower.*

All'interno della doccia, il vapore sprigiona tutto il suo potere rilassante. Il bagno turco stimola tutto l'organismo agendo sulla circolazione del sangue e sulle tensioni muscolari, in modo da ridurre lo stress. La combinazione tra vapore, doccia e l'idromassaggio permette di godere pienamente dei benefici dell'acqua in un unico ambiente.

*Steam releases all its relaxing power inside the shower. A Turkish bath stimulates the entire body and reduces stress with positive effects on blood circulation and muscle tension. The combination of steam, shower, and whirlpool allows you to enjoy all the benefits of water in one place.*

### L'idromassaggio nella doccia.

*The whirlpool shower bath.*

Nell'ambiente doccia multifunzione, i jet idromassaggio completano il percorso benessere sfruttando la pressione e la temperatura dell'acqua. La posizione delle bocchette e le differenti modalità di getto sono studiate per agire su tutte le parti del corpo: i benefici si sentiranno su collo, braccia, schiena e gambe, ma anche sulla mente.

*In the multifunction shower cabin, the whirlpool jets complete the wellness path exploiting the water pressure and temperature. The position of the nozzles and the different water jet modes are designed to act on the whole body. You can feel all the benefits on your neck, arms, back, legs, but also on your mind.*



# TEMPO

collection

Cabina multifunzione con allestimento wellness completo, per un ambiente di comfort e bellezza. L'illuminazione è realizzata in modo scenografico: una serie di led distribuiti sul tetto crea questa spettacolare opzione per la cromoterapia disponibile nei modelli junior.

È uno dei tanti particolari di pregio, come il display digitale, la mensola porta oggetti a due livelli e la seduta in acrilico trasparente. Il comfort raggiunge livelli di eccellenza, unendo tecnica e design.

*Multifunctional shower cabin with complete wellness set-up for your comfort and beauty. The lighting is created in a scenographic way: a series of LEDs distributed on the roof creates this spectacular option for chromotherapy available in the junior models. It is one of the many valuable details, such as the digital display, the two-level shelf and the transparent acrylic seat. Comfort reaches levels of excellence, combining technique and design.*



**PRODOTTO FUORI PRODUZIONE  
COME DA CIRCOLARE N.4 - AGGIORNAMENTO LISTINI 25/03/2022**

# Tempo

collection



**DIMENSIONI**  
120x80 cm

**CARATTERISTICHE**  
angolo sx nero

**DIMENSIONS**  
120x80 cm

**SPECIFICATIONS**  
corner left black

# Tempo

collection

**DIMENSIONI**  
90x90 cm

**CARATTERISTICHE**  
a parete grigio

**DIMENSIONS**  
90x90 cm

**SPECIFICATIONS**  
wall grey



## Tempo

### Caratteristiche tecniche Technical details

#### SISTEMI

Tempo Integra  
Tempo Junior  
Tempo curvo Integra  
Tempo curvo Junior

#### INSTALLAZIONE

Angolo - Parete  
Nicchia

#### SYSTEMS

Tempo Integra  
Tempo Junior  
Tempo curved Integra  
Tempo curved Junior

#### INSTALLATION

Corner - Wall  
Niche

#### Apertura laterale Open side

SX LH DX RH

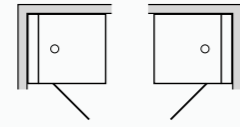

80x90 90x90 100x80  
100x90 120x80 100x100

#### Apertura frontale Open front

SX LH DX RH

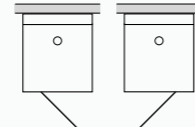

90x80 90x90

#### Apertura laterale Open side

SX LH DX RH

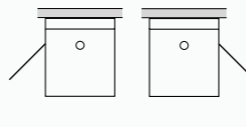

90x80 90x90

#### Apertura laterale Open side

SX LH DX RH

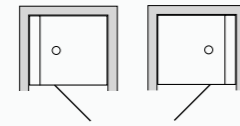

90x80 90x90 100x80  
100x90 120x80 100x100

#### Apertura laterale Open side

SX LH DX RH

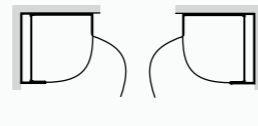

90x80 100x90 100x100  
120x80

#### CARATTERISTICHE

**Maniglia** La maniglia metallica è un brillante esempio di equilibrio tra forma e funzione. In linea con l'estetica dal gusto tecnico, crea con l'essenzialità del rigore geometrico una facile apertura.

**Rubinetteria termostatica** La forma dei rubinetti termostatici è una vera stilizzazione geometrica. In due semplici cilindri cromati è racchiusa la capacità di regolare l'acqua. Il design si esprime in ogni dettaglio.

#### SPECIFICATIONS

**Handle** Metallic handle it is a smart example of equilibrium between shape and usability. Besides the technical shape creates an easy opening together with the geometric exactness.

**Thermostatic tap** The particular shape of thermostatic faucets is a true geometric stylization. In two simple chromed cylinders is contained the ability to regulate the water. Design is expressed in every single details.



#### CROMOTERAPIA

La luce colorata ha una diretta influenza sullo stato d'animo. La sua lunghezza d'onda, opportunamente veicolata, penetra nella pelle favorendo le funzioni biologiche e il riequilibrio psico-fisico. L'associazione alle altre tecniche come l'idromassaggio o il bagno turco completa l'approccio di Hafro al benessere.

#### CROMOTHERAPY

Coloured light has a direct influence on state of mind. Its wavelength, it penetrates in the skin favouring the biological functions and the psycho-physical equilibrium. The association to the other techniques as the hydromassage or the turkish bath completes Hafro approach to comfort.



#### SGABELLO

Che abbia la trasparenza del plexiglas, la lucentezza del metallo o la delicatezza del Corian®, lo sgabello è un elemento fondamentale per il comfort del box doccia con idromassaggio o bagno turco. La posizione seduta consente di apprezzare al meglio le straordinarie virtù di questo box.

#### SEATS

Whatever the transparency of the plexiglas or the brightness of the metal, the seat is a fundamental element for the comfort of the shower cabin with hydromassage or steam bath. The sitting position allows to appreciate to the best the extraordinary virtues of this cabin.



#### FINITURE FINISHES



Moka

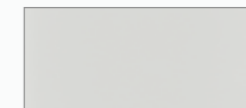

Bianco  
White



Grigio  
Grey



Ruggine  
Orange Rust



Blu Oltremare  
Oversea Blue



Nero  
Black

# SOUL

collection

Cristalli temperati con profili cromati.  
L'effetto del soffione centrale potenziato da soffioni verticali.  
In 120 per 80 cm ci sono il piacere e l'eleganza.

*Tempered crystal glasses with chrome profiles.  
The effect of the central showerhead is enhanced by vertical jets.  
Comfort and elegance in a beautiful shower cabin.*



# Soul

collection



**DIMENSIONI**  
100x90 cm

**CARATTERISTICHE**  
sx junior bianco

**DIMENSIONS**  
100x90 cm

**SPECIFICATIONS**  
left junior white

# Soul

## Caratteristiche tecniche Technical details

### SISTEMI

**Soul Integra**  
tetto + soffione

**Soul Junior**  
tetto + soffione  
+ display

### SYSTEMS

**Soul Integra**  
roof + headshower

**Soul Junior**  
roof + headshower  
+ display

### INSTALLAZIONE

Angolo - Nicchia

### ALTEZZA PIATTO

H 8 cm - H 14 cm

### INSTALLATION

Corner - Niche

### SHOWER TRAY

#### HEIGHT

8 cm H - 14 cm H

### Angolo

Corner

SX LH

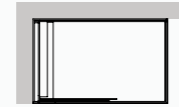

100x70  
120x70  
140x70

DX RH



100x80  
120x80  
140x80

100x90  
120x90  
140x90

### Nicchia

Niche

SX LH

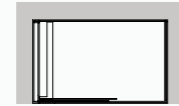

100x70  
120x70  
140x70

DX RH



100x80  
120x80  
140x80

100x90  
120x90  
140x90

### DISPOSITIVI E DOTAZIONI

Il telecomando nella versione Junior controlla tutte le funzioni, la frequenza, il volume della radio, la temperatura e la durata del bagno turco. Luce di serie o accessorio cromoterapia. L'ambiente si colora di luce per potenziare l'effetto rigenerante della doccia.

### DEVICES AND EQUIPMENT

The remote control in the Junior version manage all the functions, the frequency, the volume of the radio, the temperature and duration of the Turkish bath. Standard light or chromotherapy accessory. The space get colored by light to enhance the effect of rejuvenating shower.



Piatto doccia H 8 cm con profilo e copripiletta in Acciaio Inox.  
Shower tray 8 cm H with Stainless steel profile and waste cover.



Piatto doccia H 14 cm con profilo e copripiletta in Acciaio Inox.  
Shower tray 14 cm H with Stainless steel profile and waste cover.

### ACCESSORI

#### ACCESSORIES



Soffione 20x20 con luce di serie o accessorio cromoterapia per versione Junior.

20x20 shower head with standard light or chromotherapy as option for the Junior version.



Display per la visualizzazione dei parametri per versione Junior. Telecomando con calamita.

Display for the parameters for the Junior version. Remote control with magnet to be placed in the shower panel.



Vano tecnico ispezionabile facilmente removibile con mensola integrata.

Easily inspectionable technical compartment with integrated shelf.

### FINITURE

Le pareti e il tetto del box sono realizzati con un pannello composito formato da: alluminio, materiale poliuretano ad alta densità e, nella parte esterna, alluminio rivestito con una speciale finitura acrilica Bianco Lucido. Anche il piatto doccia del box è realizzato con un pannello composito formato da: alluminio, PVC e alluminio rivestito con una speciale finitura acrilica Bianco Lucido.

### FINISHES

The walls and the roof of the cubicle are made of a composite panel consisting of: aluminum, high-density polyurethane material and, on the outside, aluminum coated with a special Glossy White acrylic finish. The shower tray is also made of a composite panel made of aluminum, PVC and aluminum, coated with a special Glossy White acrylic finish.



Acrilico Bianco Lucido. Copripiletta in acciaio. Profilo in acciaio inox.

Gloss White Acrylic. Steel waste cover. Stainless steel profile.

# SOUND

collection

Cabina doccia multifunzione in cristallo e alluminio.  
Cristalli temperati e profilo cromato.  
L'innovazione della colonna con installazione ad angolo.  
La comodità della seduta apri e chiudi.

*Multifunction shower cabin in crystal glass and aluminum.  
Crystal glass walls with chromed profiles.  
Corner installation shower column is the focus point  
of this shower cabin.  
Open/ close seat means comfort and relax.*





# Sound

collection

**CARATTERISTICHE**

Sound Integra  
pannelli finitura Bianco  
piatto doccia 90x90x8 H cm

**SPECIFICATIONS**

Sound Integra  
white panels finishes  
shower tray 90x90x8 H cm

# Sound

collection



## CARATTERISTICHE

Sound Junior  
pannelli finitura Bianco  
piatto doccia tondo 90x90x8 H cm

## SPECIFICATIONS

Sound Junior  
white panels finishes  
round shower tray 90x90x8 H cm



## Dispositivi e dotazioni Sound

*Sound devices and equipment*



Sedile reclinabile  
*Open/close seat*



Doccetta con asta doccia  
*Handshower on slide bar*



Piatto doccia H 8 cm  
*Shower tray 8 cm H*



Piatto doccia H 14 cm  
*Shower tray 14 cm H*

## Sound

### Caratteristiche tecniche Technical details

#### VERSIONE STEP

Cabina doccia multifunzione - colonna ad angolo - pareti laterali in cristallo 6 mm - doccia raining con asta doccia - 3 jets idromassaggio - piatto doccia in acrilico - chiusura scorrevole finitura brillantata e in cristallo di sicurezza 6 mm - pannello piatto H 8 (prevedere incasso per piletta) /14 cm

#### VERSIONE INTEGRA

Cabina doccia multifunzione - colonna ad angolo - pareti laterali in cristallo 6 mm - doccia raining con asta doccia - 3 jets idromassaggio - piatto doccia in acrilico - chiusura scorrevole finitura brillantata e in cristallo di sicurezza 6 mm - pannello piatto H 8 (prevedere incasso per piletta) /14 cm - tetto con soffione

#### VERSIONE COMFORT

Cabina doccia multifunzione - colonna ad angolo - pareti laterali in cristallo 6 mm - doccia raining con asta doccia - 3 jets idromassaggio - piatto doccia in acrilico - chiusura scorrevole finitura brillantata e in cristallo di sicurezza 6 mm - pannello piatto H 8 (prevedere incasso per piletta) /14 cm - tetto con soffione - sedile reclinabile - erogatore di vapore per bagno turco con comando meccanico (on-off)

#### VERSIONE JUNIOR

Cabina doccia multifunzione - colonna ad angolo - pareti laterali in cristallo 6 mm - doccia raining con asta doccia - 3 jets idromassaggio - piatto doccia in acrilico - chiusura scorrevole finitura brillantata e in cristallo di sicurezza 6 mm - pannello piatto H 8 (prevedere incasso per piletta) /14 cm - tetto con soffione - sedile reclinabile - radio - erogatore di vapore per bagno turco con display e comandi digitali

#### STEP VERSION

*Multifunction shower cabin - corner installation shower column - Raining hand shower with shower rod - acrylic shower tray 8 cm H (enclased drain required) / 14 cm - crystal glass sliding door enclosure 6 mm thick - n. 3 hydromassage jets*

#### INTEGRA VERSION

*Multifunction shower cabin - corner installation shower column - Raining hand shower with shower rod - acrylic shower tray 8 cm H (enclased drain required) / 14 cm - crystal glass sliding door enclosure 6 mm thick - built-in roof head shower - n. 3 hydromassage jets*

#### COMFORT VERSION

*Multifunction shower cabin - corner installation shower column - Raining hand shower with shower rod - acrylic shower tray 8 cm H (enclased drain required) / 14 cm - crystal glass sliding door enclosure 6 mm thick - built-in roof head shower - open close seat - steam generator - mechanic control - n. 3 hydromassage jets*

#### JUNIOR VERSION

*Multifunction shower cabin - corner installation shower column - Raining hand shower with shower rod - acrylic shower tray 8 cm H (enclased drain required) / 14 cm - crystal glass sliding door enclosure 6 mm thick - built-in roof head shower - open close seat - steam generator - mechanic control - n. 3 hydromassage jets - radio - steam generator with digital control*

#### INSTALLAZIONE INSTALLATION

##### Dimensioni angolo Corner measurement

90x70	100x80
100x70	120x80

##### Dimensioni angolo Corner measurement

80x80	90x90
-------	-------

##### Dimensioni angolo tondo Round corner measurement

90x90
-------

SX LH

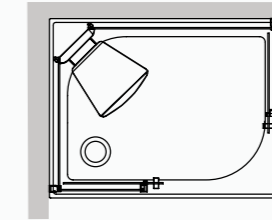

DX RH

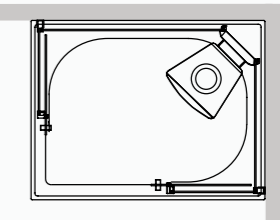

SX LH

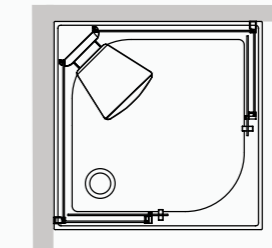

DX RH

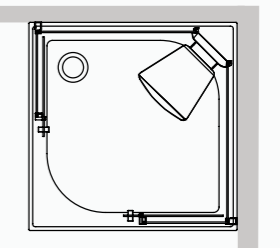

SX LH

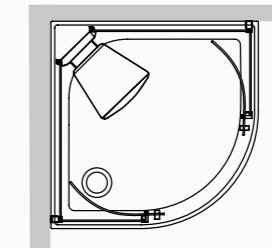

DX RH

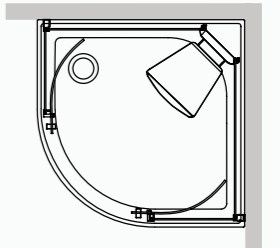

#### COLORI PARETI BOX SHOWER CUBICLE PANELS COLOURS



Bianco  
White



# VASCHE IDROMASSAGGIO

## HYDROMASSAGE TUBS

**Rio** <sup>290</sup>

**Calle | Move** <sup>300</sup>

**Skill-Up | Skill** <sup>316</sup>

**Sensual** <sup>324</sup>

**Minerva** <sup>330</sup>

**Bolla** <sup>346</sup>

**For All** <sup>370</sup>

**Mode** <sup>374</sup>

**Era Plus | Era** <sup>380</sup>

**Eva** <sup>388</sup>

**Zaphiro** <sup>394</sup>

**Oasy** <sup>395</sup>

**Duo** <sup>396</sup>

**Ondaria** <sup>397</sup>

**Gamma** <sup>398</sup>

**Igloo** <sup>399</sup>

**Ego** <sup>400</sup>

**Diva** <sup>401</sup>

**Nova** <sup>402</sup>

**Nova Plus** <sup>405</sup>

**Old Tme** <sup>406</sup>

# I BENEFICI DELL'IDROMASSAGGIO

*The benefits of whirlpools*



Nella vasca idromassaggio, la forza e il calore dell'acqua, insieme alla pressione dell'aria, sono gli elementi chiave per un trattamento benefico che, in base alle esigenze, può essere rilassante o rivitalizzante. Dopo una giornata stressante o dopo un'attività sportiva faticosa, immergersi nella vasca idromassaggio è l'ideale sia per riacquistare energia sia per prepararsi a un sonno ristoratore:

- Bagno rivitalizzante: 20-25 minuti in acqua quasi fredda (17-27°C).
- Bagno rilassante: 15-20 minuti in acqua calda (34-38°C).

*In the bathtub, the strength and the warmth of the water, together with the air pressure, are the key elements for a beneficial treatment that, depending on the needs, can be relaxing or revitalizing. After a stressful day or after a strenuous sporting activity, relaxing in the bathtub is ideal both for regaining energy and for preparing to a restful sleep:*

- *Revitalizing bath: 20-25 minutes in almost cold water (17-27 ° C).*
- *Relaxing bath: 15-20 minutes in hot water (34-38 ° C).*



## UNA VASCA IDROMASSAGGIO PER OGNI AMBIENTE.

***A whirlpool tub for every environment.***

Il calore dell'acqua attenua i dolori articolari e muscolari, mentre l'idromassaggio favorisce la circolazione sanguigna e linfatica, specie nelle gambe, aiutando a risolvere i problemi di cattiva circolazione, ritenzione idrica e cellulite. Nelle vasche idromassaggio Hafro, si può anche ascoltare la propria musica preferita e godere l'effetto della cromoterapia e delle fragranze per l'aromaterapia.

*The warmth of the water attenuates the joint and muscular pains, while the hydromassage promotes blood and lymphatic circulation, especially in the legs, helping to solve the problems of poor circulation, water retention and cellulitis. In the Hafro whirlpools you can also listen to your favorite music and enjoy the effect of color therapy and aromatherapy fragrances.*

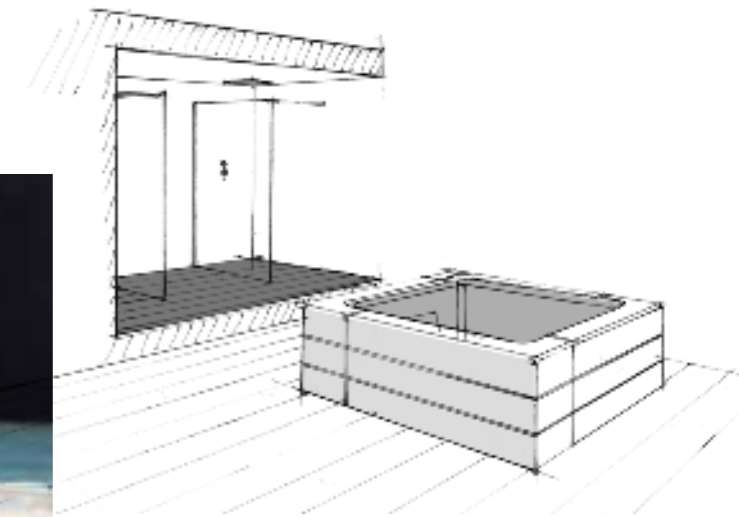

Nelle vasche idromassaggio Hafro, l'effetto benefico è dato dall'azione di diversi sistemi idromassaggio, ad aria e ad acqua, organizzati in molteplici configurazioni.

*The beneficial effect of Hafro whirlpool baths is due to the action of different air and water whirlpool systems arranged in multiple configurations.*



#### **AIRPOOL** (optional ozonoterapia)

Dalle bocchette escono infinite micro bollicine d'aria che rilassano in profondità anche chi ha pelle e capillari delicati. Il sistema Airpool è disponibile anche con ozonoterapia, che permette un effetto stimolante della circolazione periferica e una pulizia a fondo della cute, grazie al potere disinfettante naturale dell'ozono.

*Numerous jets produce endless micro air bubbles which deeply relax even sensitive skin and capillaries. Airpool system is also available with ozone therapy. Thanks to the natural disinfectant power of the ozone it allows a stimulating effect of the peripheral circulation and a deep cleansing of the skin.*

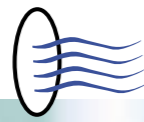

#### **WHIRLPOOL**

Acqua e aria si riuniscono in un getto ideale per il trattamento vascolare, per riequilibrare il metabolismo dei tessuti e rassodare il corpo.

*Water and air gather in an ideal throw for the vascular treatment, to balance the metabolism of tissues and to harden the body.*

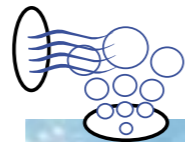

#### **WHIRLPOOL AIRPOOL**

Le due dimensioni dell'idromassaggio insieme per sciogliere le tensioni, tonificare i tessuti e stimolare la circolazione in un abbraccio globale e completo.

*Two different hydromassage system are combined together to dissolve the tensions, to invigorate the tissues and to stimulate the blood circulation in a global and complete approach.*

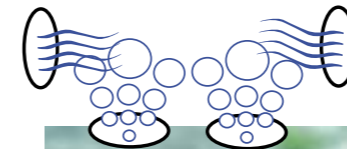

#### **PROFESSIONAL WHIRLPOOL AIRPOOL**

Tutte le funzioni Whirlpool Airpool per un idromassaggio completo e rigenerante.

*All the Whirlpool Airpool functions for a complete and regenerating water massage.*



#### **ULTRAWHIRLPOOL**

Ultrawhirlpool nasce dalla ricerca e dallo sviluppo di un sistema innovativo di gestione dell'elettronica, che ti permette di sentire solo il suono dell'acqua durante l'idromassaggio. La silenziosità dell'idromassaggio diventa la caratteristica principale del benessere.

*Ultrawhirlpool was born from the research and development of an innovative system, which allows you to hear only the sound of water during the hydromassage. The silence of the whirlpool becomes the main feature of your well-being.*

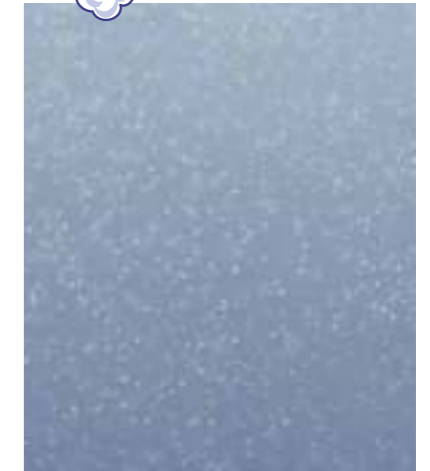

#### **MICROSILK®**

È un sistema di idromassaggio che sfrutta un getto speciale per produrre una nuvola di micro-bolle contenenti un miscuglio di ossigeno, nitrogeno ed altri gas.

*It is a whirlpool system which uses a special jet to produce a cloud of micro-bubbles containing a mixture of oxygen, nitrogen and other gases.*

# SISTEMI IDROMASSAGGIO

## Whirlpool systems

# Microsilik®

## L'innovativo sistema di idromassaggio The innovative whirlpool system



Microsilik® è la nuova frontiera dell'idroterapia, un'autentica fonte di benessere e giovinezza. Un getto speciale produce una nuvola di microbolle di ossigeno, che idrata la pelle e ha effetti benefici sulla respirazione. Grazie alle loro piccole dimensioni, le bolle entrano nei pori della pelle, eliminando le impurità e portando ossigeno ai tessuti. Con un elevato effetto detox, idratante e anti-invecchiamento, il sistema Microsilik® è ideale anche per chi soffre di psoriasi. Inoltre, le microbolle rilasciano alti livelli di anioni (particelle con carica elettrica negativa) che infondono una sensazione di relax e migliorano il sonno.

*The innovative whirlpool system Microsilik® is the new frontier of hydrotherapy, a true source of wellness and youth. A special jet produces a cloud of microbubbles of oxygen, which moisturizes the skin and has beneficial effects on breathing. Thanks to their small size, the bubbles enter the pores of the skin, eliminating impurities and bringing oxygen to the tissues. With a high detox, moisturizing and anti-aging effect, the Microsilik® system is also ideal for those suffering from psoriasis. In addition, microbubbles release high levels of anions (particles with a negative electrical charge) that infuse a feeling of relaxation and improve sleep.*

### NATURALE PULIZIA E IDRATAZIONE DELLA PELLE

Microsilik® ossigena l'acqua fino al 70% in più rispetto ai sistemi utilizzati nelle normali SPA. Le microbolle hanno un diametro di 50 micron e sono in grado di idratare ed esfoliare la pelle, rimuovendo le impurità.

### EFFETTO SAUNA

Rompendosi, le microbolle rilasciano energia termica nell'atmosfera e mantengono il calore nella vasca e intorno al corpo. Questo crea un effetto sauna che migliora la circolazione, aumenta l'attività cardiovascolare e apre i pori della pelle favorendo il rilascio delle tossine.

### MASSIMO RELAX CON GLI IONI A CARICA NEGATIVA

Tramite un getto speciale, il sistema di idromassaggio Microsilik® produce una nuvola che avvolge il corpo con ioni negativi, utili per combattere i radicali liberi e migliorare i livelli di serotonina, con un immediato effetto positivo sulla pelle e sull'umore.

### NATURAL CLEANING AND HYDRATION OF THE SKIN

*Microsilik® oxygenates water up to 70% more than the systems used in normal SPAs. The micro-bubbles have a diameter of 50 microns and are able to hydrate and exfoliate the skin, removing impurities.*

### SAUNA EFFECT

*By breaking, the microbubbles release thermal energy into the atmosphere and keep the heat in the bathtub and around the body. This creates a sauna effect that improves circulation, increases cardiovascular activity and opens the pores of the skin, promoting the release of toxins.*

### MAXIMUM RELAXATION THROUGH IONS WITH NEGATIVE CHARGE

*Using a special jet, the Microsilik® whirlpool system produces a cloud that envelops the body with negative ions, useful to fight free radicals and improve serotonin levels, with an immediate positive effect on the skin and mood.*



### CROMOTERAPIA Colour therapy

La luce regola l'organismo sia dal punto di vista psicologico sia da quello fisiologico. Infatti influisce sull'umore, sulla memoria, sull'attenzione, ma anche sulla temperatura corporea e sul battito cardiaco. L'influenza sullo stato d'animo dipende anche dall'effetto che il colore della luce ha sul sistema percettivo e sulla psiche. Ad esempio, il rosso aumenta i livelli di reattività, mentre il blu predispone alla calma e all'introspezione.

*Light regulates the body, psychologically and physiologically. In fact it affects mood, memory, attention, but also on body temperature and heart rate. Its influence on mood also depends on the effect that the colour of the light has on the perceptual system and on the psyche. For example, red increases levels of reactivity, while blue induces calm and introspection.*

### AROMATERAPIA E FITOTERAPIA Aromatherapy and phytotherapy

La fitoterapia, cioè l'uso a scopo terapeutico delle piante, è una pratica molto antica. Da foglie, fiori, frutti, semi, corteccia, legno, radici etc. di varie piante si ricavano gli oli essenziali, che sono degli estratti aromatici. Liberando le essenze profumate nell'acqua o nell'ambiente, un trattamento sfrutta i benefici dell'aromaterapia e le molteplici proprietà degli oli essenziali: antispasmodica, mucolitica, ansiolitica, analgesica etc. Inoltre, i profumi influiscono sullo stato d'animo, anche in base memoria olfattiva che si associa alla loro fragranza.

*Phytotherapy, or rather the use of plants for medicinal purposes, is a very ancient practice. Essential oils, which are aromatic extracts, are derived from leaves, flowers, fruits, seeds, bark, wood, roots etc. Releasing these perfume essences in water or in the environment for treatments that exploits the benefits of aromatherapy and the multiple properties of essential oils: antispasmodic, mucolytic, anxiolytic, analgesic, etc. In addition, aromas affect state of mind, including in the olfactory memory base that is associated with their fragrance.*



# BOCCHETTE

Diversi stili e tipologie di jet idromassaggio  
*Different styles and types of whirlpool jets*



Due versioni, Cromo o Bianco, per le bocchette idromassaggio orientabili che rilasciano un getto diretto ed energetico per rendere completo e intenso il benessere.

*Two versions, Chrome or White, for adjustable whirlpool jets that release a direct and energetic jet to make wellness complete and intense.*

Modelli: **BOLLA - FOR ALL**

Le bocchette orientabili, disponibili in versione Cromo o Bianco, permettono di direzionare il getto a seconda delle esigenze. L'intensità si può regolare chiudendo parzialmente le bocchette.

*The adjustable jets, available in Chrome or White versions, allow the jet to be directed according to requirements. The intensity can be adjusted by partially closing the jets.*

Modelli: **DUO - ONDARIA - GAMMA - IGLOO - EGO - DIVA - NOVA - NOVA PLUS**



Disponibili nella versione Bianco, le bocchette a filo sono orientabili e lasciano la superficie della vasca esteticamente pulita integrandosi nella superficie.

*Available in the White version, the flush to bathtub side jets are adjustable and leave the surface of the bathtub aesthetically clean and integrated into the surface.*

Modelli: **MINERVA - MODE - ERA - ERA PLUS - EVA - ZAPHIRO - OASY**



Le bocchette idromassaggio a filo vasca sono invisibili, direzionabili e retroilluminate dalla cromoterapia. Il design piatto e minimal dà continuità alla superficie e garantisce una funzionalità completa.

*The flush to bathtub side hydromassage jets are invisible, directional and backlit for chromotherapy. The flat and minimal design gives continuity to the surface and guarantees complete functionality.*

Modello: **RIO**

# DISINFEZIONI

Più sistemi per pulire la vasca idromassaggio  
*More systems to clean the bathtub*



## Sistema liquido

La disinfezione dell'impianto idromassaggio è di serie nei sistemi digitali. Il processo avviene a vasca piena grazie all'uso di liquido disinfettante che agisce in tutte le parti dell'impianto premendo l'apposito tasto che raffigura il simbolo disinfezione.

## Sistema a diffusione Biosan

Negli impianti idromassaggio manuali la disinfezione (optional) si attiva con il sistema BIOSAN. Il processo avviene mentre si fa l'idromassaggio grazie al passaggio dell'acqua, attraverso un contenitore, di pastiglie di Bromo che mantengono inalterato il pH dell'acqua. Queste pastiglie vanno sostituite ogni 200 cicli di idromassaggio.

## Sistema a raggi UV

I raggi ultravioletti (UV) di una certa lunghezza d'onda hanno azione germicida. Questo sistema è usato nelle vasche idromassaggio per purificare con una lampada a raggi UV l'acqua, che attraversa l'impianto di ricircolo, da batteri, virus, muffe e altri microrganismi.

## Liquid system

*The disinfection of the hydromassage system is standard in digital systems. The process has to be started with full filled tub thanks to a disinfection liquid which will in this way be distributed in the complete system, this process will start pressing the disinfection button.*

## Biosan diffusion system

*The disinfection of the manual hydromassage system (optional) can be done with the system BIOSAN. The process starts during the hydromassage thanks to water going through a plastic tank with Bromo tablets, maintaining the pH of the water unaltered. The tablets have to be reinserted in the plastic tank after 200 hydromassages.*

## UV ray system

*Ultraviolet rays (UV) of a certain wavelength have germicidal action. This whirlpool bath system uses a UV ray lamp to purify water that passes through the recirculation system of bacteria, viruses, mould, and other micro-organisms.*

# MATERIALI

materials

Wellness collection



## TECNOTEK

Materiale nobile grazie alla sua composizione con resine acriliche al 100% dà la possibilità di realizzare una gamma di vasche da bagno dalla forma ovale e rettangolare.

*Tecnotek is a noble material thanks to its composition with 100% acrylic resins. It gives the possibility of creating a range of oval and rectangular bathtubs.*

Modelli: RIO - CALLE - MOVE

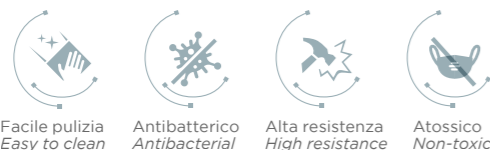

## CORIAN®

Il Corian® è un materiale tecnologico evoluto che rende la tua vasca protagonista. Composto da minerali naturali e polimeri acrilici di elevata purezza.

*Corian® is the cutting-edge technological material that will shine a spotlight on your bathtub. Composed of natural minerals and high purity acrylics polymers.*

Modello: SENSUAL



## ACRILICO

Un materiale termico, piacevole al contatto con il corpo e brillante alla vista. Le superfici in acrilico sono lisce e non porose, antiscivolo, resistenti a graffi e urti e di facile manutenzione.

*A thermal material, pleasant in contact with the body and bright to the eye. Acrylic surfaces are smooth and non-porous, non-slip, resistant to scratches and bumps and easy to maintain.*

Modelli: MINERVA - BOLLA - OASY  
MODE - NOVA - ERA - EVA  
DUO ONDARIA GAMMA - IGLOO  
EGO - DIVA - ZAPHIRO



## ACRILICO OPACO

L'acrilico è disponibile anche in versione opaca: le superfici mantengono inalterata tutte le caratteristiche di resistenza, ma esteticamente si contraddistinguono per una finitura moderna.

*The acrylic is also available in a matt version: the surfaces retain all the characteristics of resistance, but aesthetically distinguish themselves for a modern finish.*

Modelli: LINEA ERA - BOLLA  
(esclusa vasca Era 14x140 cm)  
(excluding Era tub 140x140 cm)



# RIO

collection

Hafro presenta la nuova frontiera dell'idromassaggio: Rio, la vasca idromassaggio che rilassa corpo e mente attraverso i benefici dell'acqua, della cromoterapia... e del silenzio.

8 jet idromassaggio a filo vasca e dal design minimal non interrompono la continuità della superficie in Tecnotek e allo stesso tempo garantiscono un piacevole trattamento rilassante.

*Hafro introduces the new frontier of hydromassage: Rio, the whirlpool bathtub that relaxes body and mind through the benefits of water, chromotherapy and silence. 8 whirlpool jets flush with the bathtub and with a minimal design do not interrupt the continuity of the Tecnotek surface, guaranteeing a pleasant relaxing treatment.*

**Una vasca perfetta per chi cerca di coniugare estetica e funzionalità.**

*A perfect tub for those seeking to combine aesthetics and functionality.*





**DIMENSIONI**  
200x100 cm ultrawhirpool

**DIMENSIONS**  
200x100 cm ultrawhirpool

# Rio

collection



**DIMENSIONI**  
190x90 cm ultrawhirpool

**DIMENSIONS**  
190x90 cm ultrawhirpool

# Rio

collection



**DIMENSIONI**  
190x90 cm ultrawhirpool

**DIMENSIONS**  
190x90 cm ultrawhirpool

## L'idromassaggio silenzioso Ultrawhirlpool

### *Silent Ultrawhirlpool*

Le bocchette idromassaggio sono integrate nella superficie e retroilluminate dalla cromoterapia.

*The whirlpool water jets are integrated into the surface and provided with backlit chromotherapy.*



**Rubinetteria PRESTIGE B2**  
Mix quattro fori con bocca di erogazione

**PRESTIGE B2 Taps**  
*Mix four holes with water spout*



La tastiera permette di regolare con stile l'intensità dell'idromassaggio e le funzioni della vasca.

*The digital touch control allows you to adjust with style the intensity of the whirlpool and the functions of the bath.*

Per creare un'armonia cromatica all'interno dell'ambiente bagno, lo stile della vasca può essere abbinato all'arredo bagno Geromin scegliendo finiture coordinate tra loro.

*To create a chromatic harmony inside the bathroom, the style of the bathtub can be combined with the Geromin bathroom furniture by choosing coordinated finishes.*



# CALLE MOVE

collection

Calle e Move sono realizzate in Tecnotek, un materiale innovativo dalle caratteristiche uniche: con la sua calda e piacevole sensazione tattile rende il contatto diretto un piacere inaspettato. Inoltre, le forme fluide e l'assenza di giunture creano un effetto di continuità. Calle e Move possono essere bicolori: diverse tonalità rivestono la superficie esterna per coordinare la vasca ai colori dell'arredo o per abbinarla allo stile dell'ambiente bagno.

*Calle and Move are made of Tecnotek, an innovative material with unique characteristics: with its warm and pleasant tactile sensation it makes contact an unexpected pleasure. In addition, the fluid shapes and the absence of joints create an effect of continuity. Calle and Move can be two-tone: different shades cover the external surface to coordinate the bathtub with the colours of the furniture or to match it with the style of the bathroom.*



**Calle ovale**  
collection



## Calle ovale

collection



**DIMENSIONI**  
170x80 cm

**CARATTERISTICHE**  
ovale freestanding con  
rubinetteria Rule + Bicolor nero A15

**DIMENSIONS**  
170x80 cm

**SPECIFICATIONS**  
oval freestanding position  
with with Rule tap + black A15 Bicolor

## Calle rettangolare

collection



**DIMENSIONI**  
180x80 cm

**CARATTERISTICHE**  
rettangolare ad angolo sx  
con rubinetteria Prestige B2

**DIMENSIONS**  
180x80 cm

**SPECIFICATIONS**  
rectangular corner left position  
with Prestige B2 tap



## Move ovale

collection



### DIMENSIONI

170x70 cm

### CARATTERISTICHE

ovale freestanding con  
rubinetteria e piantana tonda  
con bocca di erogazione  
+ Bicolor grigio tortora A19

### DIMENSIONS

170x70 cm

### SPECIFICATIONS

oval freestanding position  
with floor standing tap - rounded  
shape with water filling spout  
+ Dove grey A19 Bicolor

## Move rettangolare

collection



**DIMENSIONI**  
170x70 cm

**CARATTERISTICHE**  
rettangolare freestanding  
con rubinetteria quadra con  
bocca di erogazione

**DIMENSIONS**  
170x70 cm

**SPECIFICATIONS**  
rectangular freestanding  
position with squarer shape  
tap with filling spout

## Calle ovale

### Caratteristiche tecniche Technical details

#### SISTEMI

##### Vasca con telaio

Colonna di scarico integrata nella vasca c/troppo pieno  
Piletta pop-up, con tappo in finitura  
Sifone scarico in plastica

##### Vasca Airpool

Colonna di scarico integrata nella vasca c/troppo pieno  
Piletta pop-up con tappo in finitura  
Sifone scarico in plastica  
Vasca digitale airpool  
12 iniettori airpool  
Programma pulsato  
Massaggio microdiffuso con elettrosoffiante a velocità regolabile  
Sensore di livello  
Air clean system  
Cromoterapia

#### RUBINETTERIA PRESTIGE

Rubinetteria Prestige B1 Mix tre fori + bocca erogazione a cascata.  
Rubinetteria Prestige B2 quattro fori + bocca erogazione a cascata.

##### PRESTIGE TAPS

*Prestige B1 - 3 holes tap + water cascade.*  
*Prestige B2 - 4 holes tap + water cascade.*

#### RUBINETTERIA RULE B1

Mix tre fori con bocca erogazione e flessibile doccia con sistema antigoccia

##### RULE B1 TAPS

*Mix three holes with water spout and flexible hose with anti-drip system*

#### TASTIERA DIGITALE

Comandi accensione e di regolazione dell'idromassaggio airpool con più o meno intensità sono incassati nella struttura e si attivano con una semplice e lieve pressione.

##### DIGITAL KEYPAD

*The commands to turn on and regulate the airpool hydromassage to different levels of intensity are built into the structure and turned on simply with light pressure.*

#### INSTALLAZIONE

Freestanding - Parete  
Angolo - Nicchia

#### SYSTEMS

##### Bathtub with supporting frame

*In bathtub integrated drain column with overflow  
Pop-up drain, with plug in same finishing  
Plastic siphon*

##### Bathtub with airpool system

*In bathtub integrated drain column with overflow  
Pop-up drain, with plug in same finishing  
Plastic siphon  
Bathtub with airpool digital system  
12 airjets*

#### Pulsed program

*Micro-diffused massage with adjustable speed air blower  
Water level sensor  
Air clean system  
Chromotherapy*

#### INSTALLATION

Freestanding - Wall  
Corner - Niche



Prestige B1



Prestige B2



Rule B1

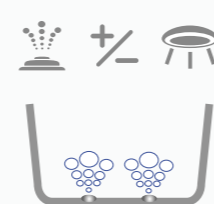

Airpool

#### FREESTANDING

155x73  
170x80



#### PARETE WALL

155x73  
170x80



#### ANGOLO CORNER

165x73  
180x80



SX LH



DX RH

#### NICCHIA NICHE

175x73  
190x80



SX LH



DX RH

#### FINITURA TECNOTEK TECNOTEK FINISH



Bianco  
White

#### FINITURA BICOLOR BICOLOR FINISH



Grigio Tortora  
Dove Grey

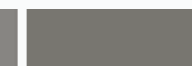

Grigio Londra  
London Grey



Grigio Scuro  
Dark Grey



Grigio Bromo  
Bromo Grey



Nero  
Black



Brown



Oceano  
Ocean



Salvia  
Sage



Timo  
Thyme



Cactus



Cipria  
Powder

## Calle rettangolare

Caratteristiche tecniche  
Technical details

### SISTEMI

#### Vasca con telaio

Colonna di scarico integrata nella vasca c/troppo pieno  
Piletta pop-up, con tappo in finitura  
Sifone scarico in plastica

#### Vasca Airpool

Colonna di scarico integrata nella vasca c/troppo pieno  
Piletta pop-up con tappo in finitura  
Sifone scarico in plastica  
Vasca digitale airpool  
12 iniettori airpool  
Programma pulsato  
Massaggio microdiffuso con elettrosoffiante a velocità regolabile  
Sensore di livello  
Air clean system  
Cromoterapia

### RUBINETTERIA PRESTIGE

Rubinetteria Prestige B1 Mix tre fori + bocca erogazione a cascata.  
Rubinetteria Prestige B2 quattro fori + bocca erogazione a cascata.

#### PRESTIGE TAPS

Prestige B1 - 3 holes tap + water cascade.  
Prestige B2 - 4 holes tap + water cascade.

### RUBINETTERIA RULE B1

Mix tre fori con bocca erogazione e flessibile doccia con sistema antigoccia

#### RULE B1 TAPS

Mix three holes with water spout and flexible hose with anti-drip system

### TASTIERA DIGITALE

Comandi accensione e di regolazione dell'idromassaggio airpool con più o meno intensità sono incassati nella struttura e si attivano con una semplice e lieve pressione.

#### DIGITAL KEYPAD

The commands to turn on and regulate the airpool hydromassage to different levels of intensity are built into the structure and turned on simply with light pressure.

### INSTALLAZIONE

Freestanding - Parete  
Angolo - Nicchia

### SYSTEMS

#### Bathtub with supporting frame

In bathtub integrated drain column with overflow  
Pop-up drain, with plug in same finishing  
Plastic siphon

#### Bathtub with airpool system

In bathtub integrated drain column with overflow  
Pop-up drain, with plug in same finishing  
Plastic siphon  
Bathtub with airpool digital system  
12 airjets

### Pulsed program

Micro-diffused massage with adjustable speed air blower  
Water level sensor  
Air clean system  
Chromotherapy

### INSTALLATION

Freestanding - Wall  
Corner - Niche



Prestige B1

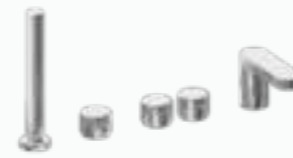

Prestige B2



Rule B1

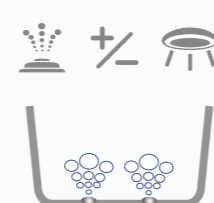

Airpool

### FREESTANDING

170x80



SX LH



DX RH

### PARETE WALL

170x80



SX LH



DX RH

### ANGOLO CORNER

180x80



SX LH



DX RH

### NICCHIA NICHE

190x80



SX LH



DX RH

### FINITURA TECNOTEK TECNOTEK FINISH

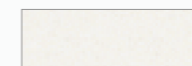

Bianco  
White

### FINITURA BICOLOR BICOLOR FINISH



Grigio Tortora  
Dove Grey

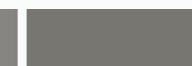

Grigio Londra  
London Grey



Grigio Scuro  
Dark Grey



Grigio Bromo  
Bromo Grey



Nero  
Black



Brown



Oceano  
Ocean



Salvia  
Sage



Timo  
Thyme



Cactus



Cipria  
Powder

## Move ovale

Caratteristiche tecniche  
Technical details

### SISTEMI

Colonna di scarico  
integrata nella vasca  
Trooppieno  
Piletta pop-up con  
tappo in finitura  
Sifone scarico in  
plastica

### INSTALLAZIONE

Freestanding

### SYSTEMS

*In bathtub  
integrated drain  
column  
Overflow  
Pop-up drain,  
with plug in same  
finishing  
Plastic siphon*

### INSTALLATION

Freestanding

### RUBINETTERIA PIANTANA

Rubinetteria a piantana quadra  
e tonda con bocca erogazione  
e mix finitura cromo.

### PEDESTAL TAPS

*Floor standing tap - square  
and rounded shape with water  
filling spout, chrome finish.*



Quadra



Tonda

### INSTALLAZIONI

#### INSTALLATION

Freestanding  
155x63



170x70



### FINITURE FINISHES

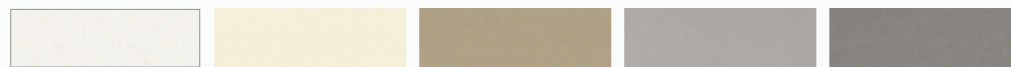

**Bianco**  
White

**Crema**  
Cream

**Terra**  
Land

**Grigio Chiaro**  
Light Grey

**Grigio Scuro**  
Dark Grey

### FINITURA BICOLOR BICOLOR FINISH



**Grigio Tortora**  
Dove Grey

**Grigio Londra**  
London Grey

**Grigio Scuro**  
Dark Grey

**Grigio Bromo**  
Bromo Grey

**Nero**  
Black

**Brown**

**Oceano**  
Ocean

**Salvia**  
Sage

**Timo**  
Thyme

**Cactus**

**Cipria**  
Powder

## Move rettangolare

Caratteristiche tecniche  
Technical details

### SISTEMI

Colonna di scarico  
integrata nella vasca  
Trooppieno  
Piletta pop-up con  
tappo in finitura  
Sifone scarico in  
plastica

### INSTALLAZIONE

Freestanding

### SYSTEMS

*In bathtub  
integrated drain  
column  
Overflow  
Pop-up drain,  
with plug in same  
finishing  
Plastic siphon*

### INSTALLATION

Freestanding

### RUBINETTERIA PIANTANA

Rubinetteria a piantana quadra  
e tonda con bocca erogazione  
e mix finitura cromo.

### PEDESTAL TAPS

*Floor standing tap - square  
and rounded shape with water  
filling spout, chrome finish.*



Quadra



Tonda

### INSTALLAZIONI

#### INSTALLATION

Freestanding  
170x70



### FINITURE FINISHES

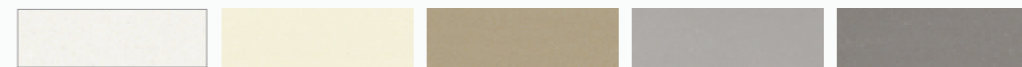

**Bianco**  
White

**Crema**  
Cream

**Terra**  
Land

**Grigio Chiaro**  
Light Grey

**Grigio Scuro**  
Dark Grey

### FINITURA BICOLOR BICOLOR FINISH



**Grigio Tortora**  
Dove Grey

**Grigio Londra**  
London Grey

**Grigio Scuro**  
Dark Grey

**Grigio Bromo**  
Bromo Grey

**Nero**  
Black

**Brown**

**Oceano**  
Ocean

**Salvia**  
Sage

**Timo**  
Thyme

**Cactus**

**Cipria**  
Powder

# SKILL-UP SKILL

collection

Una vasca in Solidtek in due versioni, con o senza troppo pieno, perfetta per la stanza da bagno, ma anche per creare un angolo di design e puro benessere nella camera da letto.

*A Solidtek bathtub in two versions, with or without overflow, perfect for the bathroom, but also for creating a corner of design and pure well-being in your bedroom.*





# Skill-Up

collection



**DIMENSIONI**  
160x70 cm con troppopieno

**DIMENSIONS**  
160x70 cm with overflow



**DIMENSIONI**  
160x70 cm

**DIMENSIONS**  
160x70 cm

## Skill-Up

### Caratteristiche tecniche Technical details

#### VASCA

Colonna di scarico  
integrata nella vasca  
Trooppieno  
Piletta pop-up  
con tappo in finitura  
Sifone scarico in  
plastica

#### BATHTUB

*Drain column  
integrated in  
the tub  
Overflow  
Pop-up drain with  
plug in finish  
Plastic drain siphon*

#### INSTALLAZIONE

Centro stanza

#### INSTALLATION

Center room

## Skill

### Caratteristiche tecniche Technical details

#### VASCA

Colonna di scarico  
integrata nella vasca  
Piletta pop-up  
con tappo in finitura  
Sifone scarico  
in plastica

#### BATHTUB

*Drain column  
integrated in  
the tub  
Pop-up drain with  
plug in finish  
Plastic drain siphon*

#### INSTALLAZIONE

Centro stanza

#### INSTALLATION

Center room

SKILL-UP  
160x70



SKILL  
160x70



## RUBINETTERIA TAPS



Rubinetteria a  
piantana quadra con  
bocca erogazione e  
mix finitura cromo

*Squared shape floor  
standing tap with  
water filling spout and  
chrome finish mix*



Rubinetteria a  
piantana tonda con  
bocca erogazione e  
mix finitura cromo

*Rounded shape floor  
standing tap with  
water filling spout and  
chrome finish mix*

## FINITURA SOLIDTEK SOLIDTEK FINISH



Bianco  
White

# SENSUAL

collection

Realizzata in Corian® e dotata di sistema idromassaggio airpool, diventa il centro di una sala da bagno dove l'estetica contemporanea dà un nuovo significato alle funzioni, aprendo orizzonti di stile, comfort e progettualità. Sensual arricchisce l'acqua di nuove sensazioni e l'arredo di nuove potenzialità.

*Corian® made and supplied with airpool hydro-massage system, becomes the heart of bathroom where beauty gives a new meaning to the functions, and open new horizons of style, comfort and project. Sensual enriches the water of new feelings and furnishing of new potentialities.*

**Vasca idromassaggio dal design fluido e funzionale, grazie anche alla seduta ergonomica, permette una posizione di assoluto relax.**

*The whirlpool bathtub with a fluid and functional design. Its ergonomic seat allows for a position of absolute relaxation.*



# Sensual

collection



**DIMENSIONI**  
190x100 cm

**CARATTERISTICHE**  
vasca airpool

**DIMENSIONS**  
190x100 cm

**SPECIFICATIONS**  
airpool bathtub

# Sensual

## Caratteristiche tecniche Technical details

### Parete Wall

### Angolo Corner

### Freestanding

250x120



220x120



190x120



190x100  
190x90  
190x80



180x100  
180x90  
180x80



### RUBINETTERIA "LOFT"

Un design geometrico per la rubinetteria da bordo vasca con tre o quattro fori, doccetta e bocca di erogazione oppure in versione piantana con bocca di erogazione e doccetta.

#### "LOFT" FAUCETS

A geometric design for bath taps with three or four holes, shower head and spout or in the upright version with spout and shower head.



Loft B1

Loft B2

### FINITURE

Le finiture della linea Sensual prevedono il rivestimento in MDF laccato nelle finiture dei colori Geromin (o nelle personalizzazioni RAL), con i ripiani nei modelli più grandi e con pannello liscio negli altri.

#### FINISHES

Sensual finishes are in lacquered MDF (Geromin colours or customized RAL selection). The bigger version are provided with holding shelves, the smallest with smooth panels.



**Pannelli e cassettiere in MDF laccato**  
I laccati sono disponibili in tutti i colori della mazzetta.  
**MDF painted panels**  
Lacquers are available in all colours of the selection swatch.

### TASTIERA DIGITALE

Comandi accensione e di regolazione dell'idromassaggio airpool con più o meno intensità sono incassati nella struttura e si attivano con una semplice e lieve pressione.

#### DIGITAL KEYPAD

The commands to turn on and regulate the airpool hydromassage to different levels of intensity are built into the structure and turned on simply with light pressure.

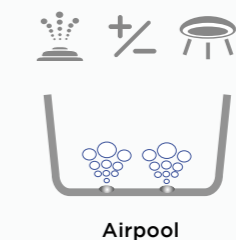

Airpool



# MINERVA

collection

La vasca Minerva è una vera e propria rivoluzione: ha la forma e le dimensioni di una vasca normale, con le caratteristiche della minipiscina e con il vantaggio di non essere svuotata dopo l'uso. Vasca per uso interno ed esterno, il sistema automatico di ricircolo mantiene l'acqua alla temperatura impostata e sempre pulita grazie ad una disinfezione UV che elimina i batteri e un filtro che trattiene le impurità. Inoltre, tra le dotazioni è compresa la cromoterapia e l'accessorio audio Bluetooth. Minerva è una vasca intelligente per tanti aspetti: per i consumi, perché assicura un risparmio di energia; per il tempo, perché è sempre pronta all'uso; per l'utilizzo più continuo e facilitato, in quanto non deve essere riempita ogni volta.

*The Minerva bathtub is a real revolution: it has the shape and size of a normal tub, with the characteristics of a minipool and with the advantage of not to be drained after use.*

*Minerva is a bathtub for indoor and outdoor use with automatic recirculation system that keeps the water at the set temperature and always clean thanks to a UV disinfection that eliminates bacteria and a filter that retains impurities. In addition, the equipment includes chromotherapy and the Bluetooth audio accessory. Minerva is an intelligent tub for many aspects: in terms of consumption, because it ensures energy savings; for the time, because it is always ready for use; for more continuous and easier use, as it does not have to be filled every time.*



## Indoor

Nella versione da interno, la vasca Minerva è disponibile con diversi sistemi idromassaggio: Airpool (micro-bolle d'aria dalle bocchette a fondo vasca), Whirlpool (getti di acqua e aria dalle bocchette laterali) o combinazione Whirlpool Airpool. Minerva Indoor con sistema Whirlpool Airpool è disponibile anche con ricircolo automatico ed è dotata di tastiera touch screen in cristallo, filtraggio a cartuccia, disinfezione dell'acqua a UV e riscaldatore.

*The Minerva indoor whirlpool tubs are available with different whirlpool systems: Airpool (air microbubbles at the bottom of the tub), Whirlpool (water and air jets from the side nozzles) or Whirlpool Airpool combination. Minerva Indoor with Whirlpool Airpool System is also available with automatic recirculation. It comes with a crystal touchscreen keypad, cartridge filtration, UV water disinfection, and a heater.*

## Outdoor

Nella versione da esterno, la vasca Minerva con impianto idromassaggio combinato Whirlpool Airpool è dotata di sistema automatico di ricircolo dell'acqua, filtraggio a cartuccia e disinfezione UV dell'acqua. La testiera touch in cristallo e il riscaldatore per il mantenimento della temperatura completano la funzionalità. Sono disponibili come optional l'impianto audio bluetooth e i pannelli di rivestimento in ecomalta, mentre la copertura termica è un accessorio.

*In the outdoor version, the Minerva Whirlpool Airpool tub comes with an automatic recirculation system, cartridge filtration, UV water disinfection, a crystal touchscreen keypad, and a heater to maintain the temperature. The Bluetooth audio system and ecomalta panels are available as options, while the thermo cover is available as an accessory.*



## Minerva indoor

collection

**DIMENSIONI**  
215x150 cm

**CARATTERISTICHE**  
vasca con cuscino  
e troppo pieno a sfioro

**DIMENSIONS**  
215x150 cm

**SPECIFICATIONS**  
tub with cushion  
and 'infinity' overflow



# Minerva indoor

collection



---

**DIMENSIONI**  
200x150 cm**CARATTERISTICHE**  
vasca con troppo  
pieno a sfioro**DIMENSIONS**  
200x150 cm**SPECIFICATIONS**  
tub with 'infinity'  
overflow

# Minerva indoor

collection



#### DIMENSIONI

215x150 cm

#### CARATTERISTICHE

vasca con cuscino  
e troppo pieno a sfioro

#### DIMENSIONS

215x150 cm

#### SPECIFICATIONS

tub with cushion  
and 'infinity' overflow

### Il sistema automatico di ricircolo.

La vasca può avere due tipi di utilizzo. In quello tradizionale l'acqua arriva appena sopra le bocchette dell'idromassaggio e il ricircolo avviene attraverso una pompa a basso consumo. Nell'utilizzo a sfioro, l'acqua in eccesso si riversa nel vano tecnico alloggiato sotto il cuscino, dove viene purificata e reimpressa nella vasca alla temperatura desiderata. Questo sistema mantiene la vasca sempre piena e pronta all'uso.

### The automatic recirculation system.

The bathtub can have two types of use. In normal use, recirculation system is performed by a low-consumption recirculation low consumption pump. In overflow use, the excess water is filed into the technical tank, where it is purified and returned to the bathtub at the desired temperature. This system keeps the bathtub always full and ready for use.

Utilizzo tradizionale della vasca  
Normal use of the bathtub

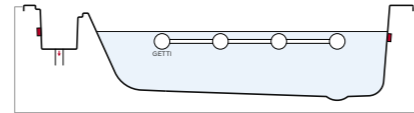

Utilizzo a sfioro della vasca  
Use of the bathtub with recirculation system

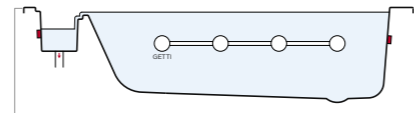

Troppo pieno  
Over flow

Alloggiamento per filtro in carta  
Position of paper filter

Cassa audio  
Audio speakers

Faro cromoterapia  
Chromotherapy lamp

Sensore di livello meccanico  
Mechanical water level sensor

Piletta di scarico per riciclo acqua  
Drain trap for water recirculation

Componentistica vano tecnico  
All components inside the technical area



In qualsiasi momento lo desideri, Minerva è pronta ad accoglierti: il sistema automatico di ricircolo igienizza l'acqua e la reimmette nella vasca, consentendone un utilizzo continuo, senza necessità di svuotarla quotidianamente. Inoltre, tramite il tastierino digitale, è possibile controllare le impostazioni della temperatura perché al momento dell'uso sia esattamente come la si desidera. Completa di impianto di disinfezione UV di serie, cromoterapia e accessorio audio Bluetooth, questa vasca può essere utilizzata come un idromassaggio tradizionale oppure può essere riempita con un effetto a sfioro, grazie ad un sistema che mantiene sempre costante il livello dell'acqua. Per una sensazione di benessere avvolgente e completa.

At any time you wish, Minerva is ready to welcome you: the automatic recirculation system keeps the water always purified and at the perfect temperature. A whirlpool bath complete with standard UV disinfection system, chromotherapy and optional Bluetooth audio, which can be used normally or completely filled with an infinity effect, for a feeling of enveloping and complete wellbeing.

# Minerva outdoor

collection



---

**DIMENSIONI**  
200x150 cm

**CARATTERISTICHE**  
vasca con troppo  
pieno a sfioro

**DIMENSIONS**  
200x150 cm

**SPECIFICATIONS**  
tub with 'infinity'  
overflow

## Minerva indoor

### Caratteristiche tecniche Technical details

#### DIMENSIONI

215x150 cm  
200x150 cm

#### CARATTERISTICHE

Realizzata in acrilico con rinforzo in vetroresina  
Disponibile pannellata nei colori laccati opaco, lucido o ecomalta  
Posizionamento free standing, angolo, parete o ad incasso

#### COME FUNZIONA

Il troppo pieno è dato da una fessura 4 cm più bassa rispetto al bordo vasca posizionato sotto la copertura del serbatoio

Si hanno quindi 2 versioni: nella prima l'acqua che va in sfioro nel troppo pieno viene direttamente scaricata; nella versione con sistema automatico di riciclo l'acqua che raggiunge il troppo pieno viene ricaricata nella vasca

Sistemi whirlpool - airpool - whirlpool airpool  
Sistema di ricircolo, filtro, riscaldatore e cromoterapia

#### MEASUREMENT

215x150 cm  
200x150 cm

#### SPECIFICATIONS

Material Acrylic Tub with fibreglass reinforcement  
Can be panelled (available in matt, glossy lacquered colours or in eco-cement)

Positioning free-standing, corner, wall, built-in

#### HOW IT WORKS

The overflow is in the form of a slit that is 4 cm lower than the edge of the tub, located under the tank cover

There will be 2 versions: the first one is simple, meaning that when the water flows out of the overflow it is immediately emptied; In the version with recirculation system the water that reaches the overflow is fed back into the tub

Systems that can be used are Whirlpool airpool whirlpool airpool  
Recirculating system, filter, heater and colour therapy

## Minerva outdoor

### Caratteristiche tecniche Technical details

#### DIMENSIONI

200x150 cm

#### CARATTERISTICHE

Vasca per installazione su verande oppure terrazze con tetto  
(la vasca non è dotata di vassoio quindi è necessario un pavimento)

Realizzata in acrilico con rinforzo in vetroresina  
Disponibile pannellata in finitura ecomalta

Posizionamento free standing, angolo, parete o ad incasso

Il serbatoio che ha funzione di troppo pieno è coperto da un pannello in ecomalta

#### COME FUNZIONA

Disponibile solo con sistema automatico di riciclo

#### MEASUREMENT

200x150 cm

#### SPECIFICATIONS

Tub designed to be installed on verandas or roofed terraces (it's important that there is a floor as the tub does not have a tray)

Material Acrylic Tub with fibreglass reinforcement  
Can be panelled (available in eco-cement)

Positioning free-standing, corner, wall, built-in

The tank for the overflow water is covered by an eco-cement panel

#### HOW IT WORKS

Available with recirculation system only

Misure disponibili / Available sizes

200x150 cm

215x150 cm

Parete  
Wall



Angolo  
Corner

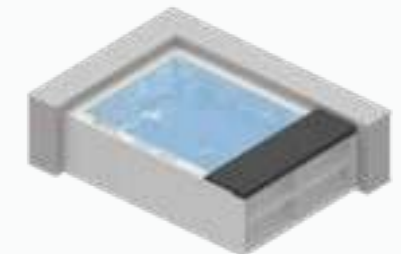
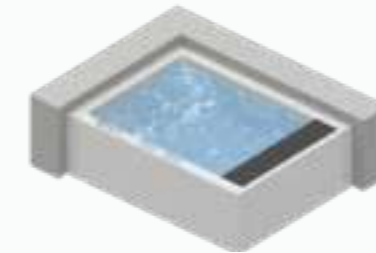

Nicchia  
Niche

Per vano tecnico consultare scheda tecnica  
For the inspection area pls check the technical data sheet

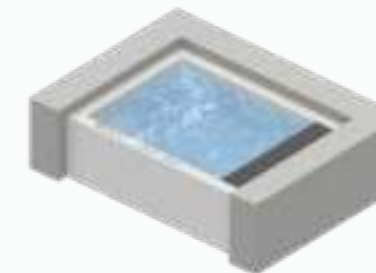

Freestanding

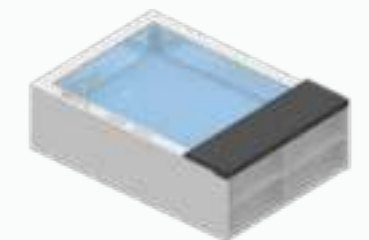

Incasso  
Built-in

Per vano tecnico consultare scheda tecnica  
For the inspection area pls check the technical data sheet

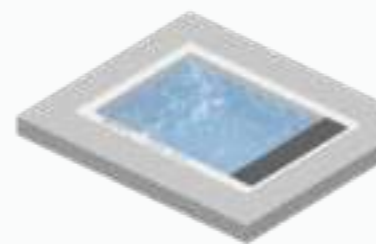

## Accessori Minerva Minerva accessories

### RUBINETTERIA "PRESTIGE" MINERVA INDOOR

Rubinetteria Prestige A2 quattro fori.  
Rubinetteria Prestige B2 quattro fori  
con bocca erogazione.

#### "PRESTIGE" TAPS MINERVA INDOOR

*Prestige A2 - 4 holes tap.*  
*Prestige B2 - 4 holes tap  
with water spout.*



Prestige A2



Prestige B2

### RUBINETTERIA TERMOSTATICA MINERVA OUTDOOR

Miscelatore termostatico a 1 ÷ 5 vie.  
Solo per installazione a muro.

#### THERMOSTATIC TAP MINERVA OUTDOOR

*1 ÷ 5 ways thermostatic mixer.*  
*Only for wall installation.*



### COPERTURA TERMICA in Ecopelle Antracite per Minerva outdoor 200x150

Copertura termica per la protezione da  
elementi esterni che involontariamente  
possono finire all'interno della vasca.  
Tale copertura manterrà il calore  
dell'acqua, sia nei periodi estivi  
che nei periodi invernali. Esclude  
rubinetteria bordo vasca.

#### THERMAL COVER in anthracite eco-leather for outdoor Minerva 200 x 150

*Thermal cover for protection from  
external elements that can involuntarily  
end up inside the bathtub.*  
*Thermal cover will maintain the warmth  
of the water, both in summer and in  
winter. Tub mounted taps can not be  
installed with thermal cover.*

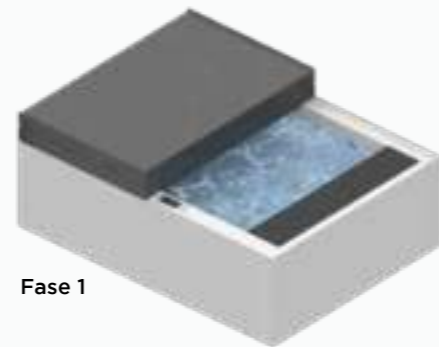

Fase 1

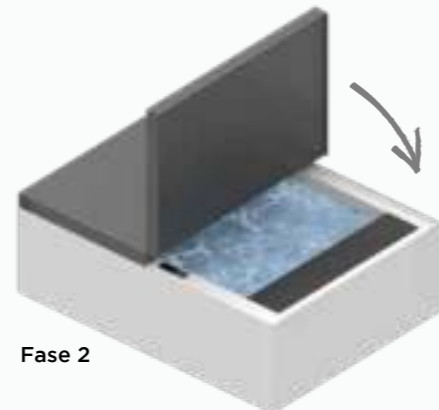

Fase 2



### TASTIERE DAL DESIGN MINIMAL ED ELEGANTE

#### DIGITAL PANELS WITH A MINIMAL AND ELEGANT DESIGN

Tastiera touch per sistema whirlpool airpool con ricircolo automatico dell'acqua  
*Touch control for whirlpool airpool with water recirculation system*



Tastiera touch funzione audio-musica, optional solo per sistema whirlpool  
airpool con ricircolo automatico dell'acqua  
*Touch control for the audio system, optional only for whirlpool airpool system  
with water recirculation system*



Tastiera digitale per sistema whirlpool  
*Digital control for whirlpool system*



Tastiera digitale per sistema airpool  
*Digital control for airpool system*



Tastiera digitale per sistema whirlpool airpool  
*Digital control for whirlpool airpool system*



# BOLLA

design Franco Bertoli

Bolla è una collezione completa e versatile di vasche idromassaggio, anche a sfioro: rotonde, rettangolari e quadrate di diverse dimensioni, in versione freestanding o con quattro modalità di incasso. Un bagno nella vasca idromassaggio Bolla è ancora più piacevole e benefico se la vasca è equipaggiata con cuscino poggiatesta, riscaldatore che mantiene l'acqua a una temperatura costante e faro per la cromoterapia.

*Bolla is a complete and versatile collection of whirlpools, also with infinity-edge: round, rectangular and square in different sizes, in the freestanding version or with different types for built in installation. A bath in Bolla is even more pleasant and beneficial if the whirlpool tub is equipped with a headrest cushion, a heater that keeps the water at a constant temperature and a light for chromotherapy.*

**Una vasca idromassaggio intelligente,  
dotata di sistemi digitali e funzionalità all'avanguardia.**

*An intelligent whirlpool, equipped with digital  
systems and cutting-edge features.*

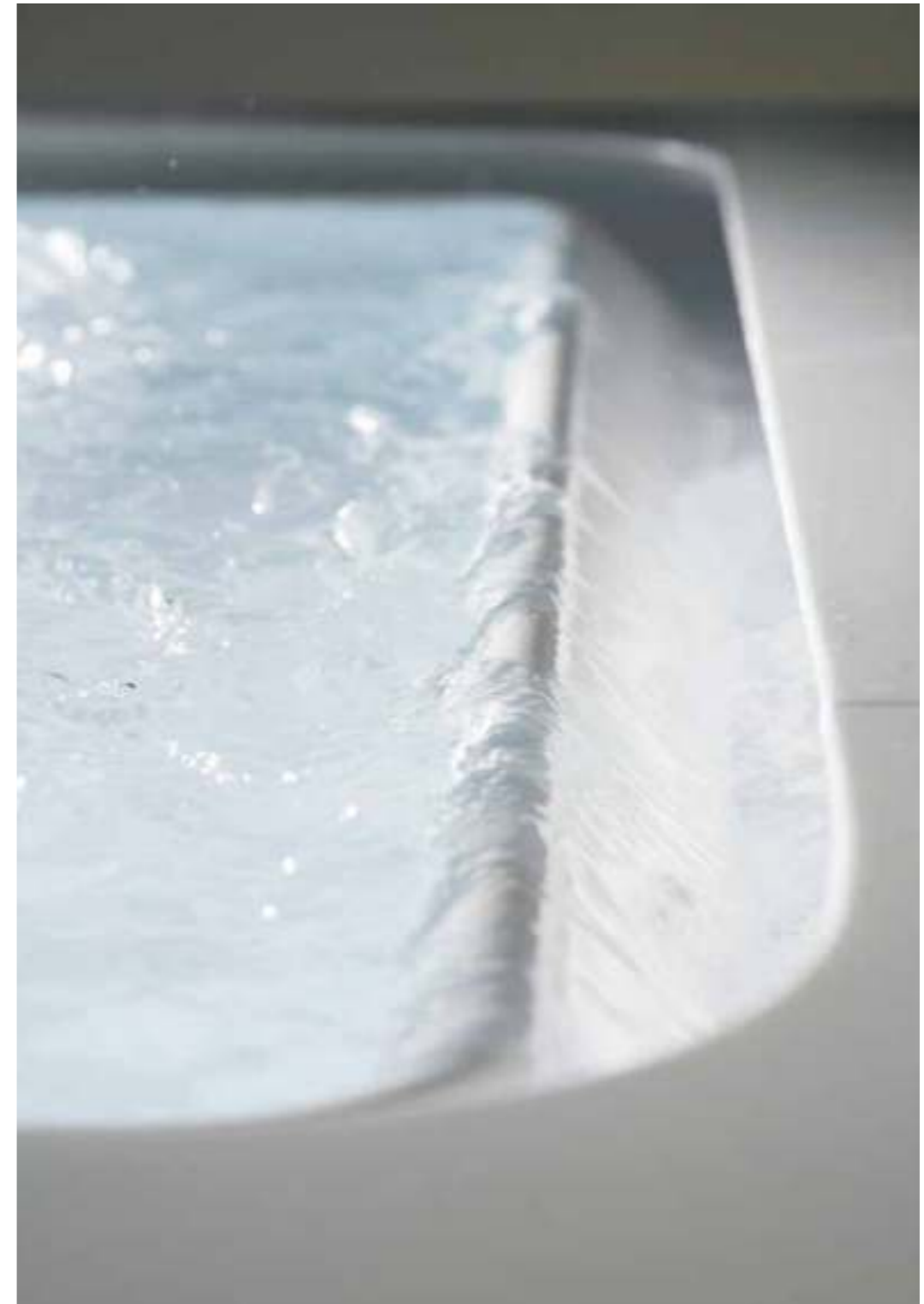

## Bolla Q SFIORO

design

Franco Bertoli

### DIMENSIONI

190x190 cm Airpool  
con sistema automatico di ricircolo

### CARATTERISTICHE

sistema automatico di ricircolo  
vasca digitale airpool  
24 iniettori airpool  
massaggio microdiffuso  
con elettrosoffiante  
a velocità regolabile  
cromoterapia (optional)  
air clean system  
riscaldatore  
ozonoterapia  
sistema disinfezione Biosan  
piletta di scarico  
sifone scarico  
colonna di scarico  
a vasi comunicanti  
sensore di livello  
faro subacqueo  
programma pulsato

### DIMENSIONS

190x190 cm Airpool  
with water recirculation system

### SPECIFICATIONS

automatic water  
purification system  
airpool digital bathtub  
24 Airpool jets  
micro-diffused massage  
by electro-blower  
with adjustable speed  
colour therapy (optional)  
air clean system  
heater  
ozone therapy  
Biosan disinfection system  
drain column  
trap drain  
overflow column  
with communicating vessels  
level sensor  
underwater light  
airpool pulsed program





## Bolla Q SFIORO

design  
Franco Bertoli



**DIMENSIONI**  
190x190 cm

**DIMENSIONS**  
190x190 cm



## Bolla<sup>R</sup> SFIORO

design  
Franco Bertoli / Davide Danielli

### DIMENSIONI

200x150 cm Airpool

### CARATTERISTICHE

vasca digitale airpool  
24 Iniettori airpool  
massaggio microdiffuso  
con elettrosoffiante  
a velocità regolabile  
cromoterapia (optional)  
air clean system  
programma pulsato  
sensore di livello  
faro subacqueo  
sistema disinfezione  
piletta di scarico  
sifone scarico

### DIMENSIONS

200x150 cm Airpool

### SPECIFICATIONS

airpool digital bathtub  
24 Airpool jets  
micro-diffused massage  
by electro-blower  
with adjustable speed  
colour therapy (optional)  
air clean system  
pulsed program  
level sensor  
underwater light  
underwater light  
drain column  
trap drain

## Bolla SFIORO Ø190

*design*  
Franco Bertoli / Davide Danielli

### DIMENSIONI

Ø 190 cm Airpool  
con sistema automatico di  
ricircolo acqua con controllo  
temperatura e disinfezione

### CARATTERISTICHE

vasca digitale airpool  
24 iniettori airpool  
programma pulsato  
massaggio microdiffuso  
con elettrosffiante  
a velocità regolabile  
cromoterapia (optional)  
faro subacqueo  
air clean system  
sensore di livello  
piletta di scarico  
colonna di scarico  
sifone scarico  
ozonoterapia  
sistema disinfezione biosan  
riscaldatore

### DIMENSIONS

Ø 190 cm Airpool  
with automatic water  
recirculation system with  
temperature control and  
disinfection

### SPECIFICATIONS

airpool digital bathtub  
24 Airpool jets  
pulsed program  
micro-diffused massage  
by electro-blower with  
adjustable speed  
colour therapy (optional)  
underwater light spot  
air clean system  
level sensor  
trap plastic drain  
overflow column  
drain column  
ozone therapy  
biosan disinfection system  
heater



## Bolla SFIORO Ø190

design

Franco Bertoli / Davide Danielli

Bolla è l'esito creativo di un design d'avanguardia, sviluppato coniugando tecnica, ergonomia ed estetica. La forma consente un volume eccezionale d'acqua. Il sistema di igienizzazione permette di utilizzarla a lungo, sempre pronta, sempre pulita, sempre con la temperatura giusta grazie ad un sistema automatico di ricircolo acqua con controllo di temperatura e disinfezione.

Il concept si sviluppa in una linea completa con le versioni a sfioro free standing o con quattro modalità di incasso.

*Bolla is the imaginative result of an avant-garde design, born by technique, ergonomics and aesthetics. Its shape contains an exceptional volume of water. The disinfection system grant the use of it for a long time, always ready, always clean, always with the right temperature thanks to an automatic water recirculation system with control temperature and disinfection. The concept develops in a complete line with free-standing infinity versions or with four ways of collection.*

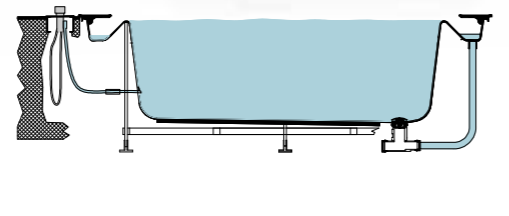
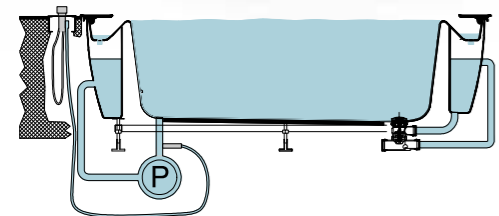

Versione Airpool con sistema con serbatoio integrato per il ricircolo dell'acqua.

*Airpool version with integrated water tank governing water purification system.*

Versione Airpool, Whirlpool e Whirlpool Airpool senza sistema di ricircolo dell'acqua.

*Airpool, Whirlpool and Whirlpool Airpool without water purification system.*



**Una finitura materica  
per un ambiente moderno.**

*Material finishing, for a  
contemporary ambience.*

## **Bolla SFIORO Ø190**

*design  
Franco Bertoli / Davide Danielli*

La resina, unita a miscele minerali,  
garantisce elevate prestazioni  
tecniche, ideali per ogni utilizzo.

*The resin, combined with mineral  
mixtures, guarantees high technical  
performance, ideal for every use.*

**DIMENSIONI**  
Ø 190 cm Airpool

**DIMENSIONS**  
Ø 190 cm Airpool

## Bolla SFIORO Ø190

design  
Franco Bertoli / Davide Danielli



**DIMENSIONI**  
Ø 190 cm Airpool

**DIMENSIONS**  
Ø 190 cm Airpool

## Bolla Ø160

design  
Franco Bertoli / Davide Danielli

### DIMENSIONI

Ø 160 cm Airpool

### CARATTERISTICHE

vasca digitale airpool  
24 iniettori airpool  
programma pulsato  
massaggio microdiffuso  
con elettrosoffiante  
a velocità regolabile  
faro subacqueo  
air clean system  
sensore di livello  
colonna di scarico  
a vasi comunicanti  
sifone scarico

### DIMENSIONS

Ø 160 cm Airpool

### SPECIFICATIONS

airpool digital bathtub  
24 Airpool jets  
airpool pulsed program  
micro-diffused massage  
by electro-blower with  
adjustable speed  
underwater light  
air clean system  
level sensor  
overflow column  
with communicating vessels  
trap drain



## Bolla Q 160X160

design  
Franco Bertoli

### DIMENSIONI

160x160 cm Airpool

### CARATTERISTICHE

vasca digitale airpool  
24 iniettori airpool  
massaggio microdiffuso  
con elettrosffiante  
a velocità regolabile  
cromoterapia (optional)  
air clean system  
sensore di livello  
sistema disinfezione (optional)  
piletta di scarico  
sifone scarico  
colonna di scarico  
a vasi comunicanti  
programma pulsato

### DIMENSIONS

160x160 cm Airpool

### SPECIFICATIONS

airpool digital bathtub  
24 Airpool jets  
micro-diffused massage  
by electro-blower with  
adjustable speed  
colour therapy (optional)  
air clean system  
level sensor  
drain column  
disinfection system (optional)  
trap drain  
overflow column  
with communicating vessels  
pulsed program



Vasca da incasso con sistema  
idromassaggio Airpool, spaziosa  
ma di dimensioni contenute.

*Built-in bathtub with  
Airpool hydromassage system,  
spacious but smaller in size.*



## Bolla R 162

design  
Franco Bertoli / Davide Danielli

Vasca da incasso di dimensioni contenute,  
per adattarsi ad ogni spazio.

*Built in tub, minimum amount of space,  
suitable for every room.*

### DIMENSIONI

162x112 cm Airpool

### CARATTERISTICHE

vasca digitale airpool  
24 iniettori airpool  
massaggio microdiffuso  
con elettrosffiante  
a velocità regolabile  
air clean system  
sensore di livello  
sifone scarico  
colonna di scarico  
a vasi comunicanti  
programma pulsato  
faro subacqueo

### DIMENSIONS

162x112 cm Airpool

### SPECIFICATIONS

airpool digital bathtub  
24 Airpool jets  
micro-diffused massage  
by electro-blower with  
adjustable speed  
air clean system  
level sensor  
trap drain  
overflow column  
with communicating vessels  
pulsed program  
underwater light



# Bolla

## Caratteristiche tecniche Technical details

### INSTALLAZIONE

La naturalezza dell'acqua ispira una linea completa di vasche progettata nella versione a sfioro da 190ø / 190Q / R200 freestanding o con quattro modalità di incasso.

### INSTALLATION

Elegance of water inspires a complete line of tubs: sfioro edge, 190ø / 190Q / R200 in the freestanding version or with four different way of built-in installation.

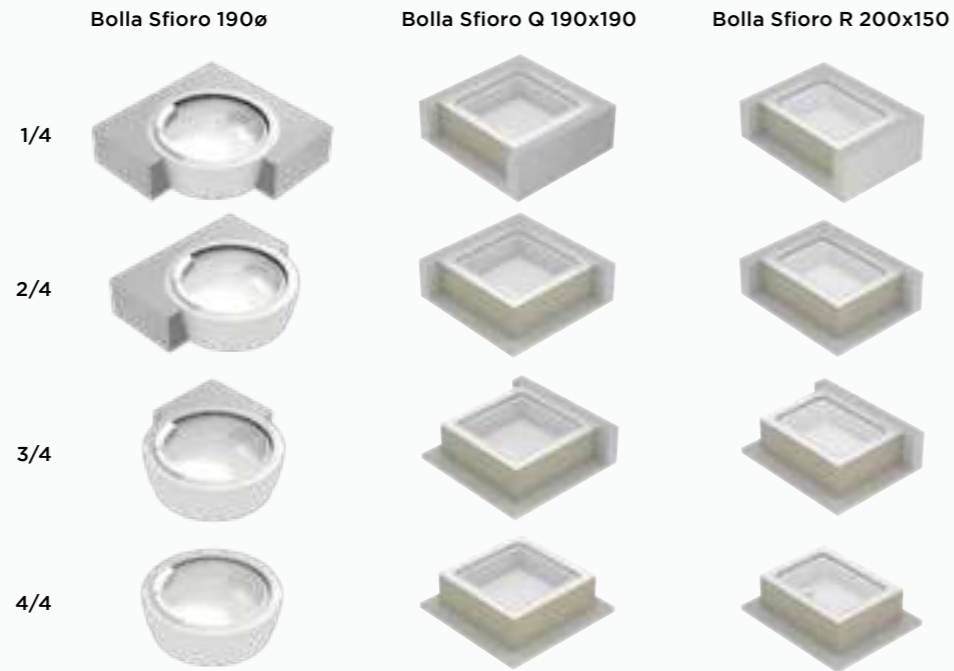

### TASTIERA DIGITALE PER BOLLA CON RICIRCOLO DELL'ACQUA

Dopo l'accensione con il tasto installato nella vasca, tutte le funzioni si controllano comodamente mediante un telecomando.

### DIGITAL KEYPAD FOR BOLLA WITH WATER PURIFICATION SYSTEM

Switch on pressing key built in the tub: every function can be easily controlled using hi-tech remote control.

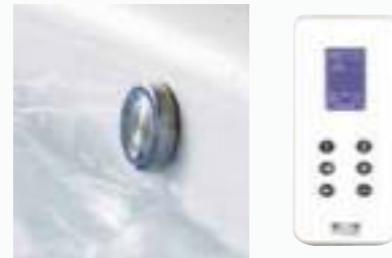

### TASTIERA DIGITALE PER BOLLA SENZA RICIRCOLO DELL'ACQUA

Le funzioni di idromassaggio della versione senza ricircolo d'acqua si attivano direttamente dalla vasca attraverso un tastiera digitale.

### DIGITAL KEYPAD FOR BOLLA WITH WATER PURIFICATION SYSTEM

The hydromassage functions, on versions without water purification systems, can be directly activated from the tub itself, using digital keypad.

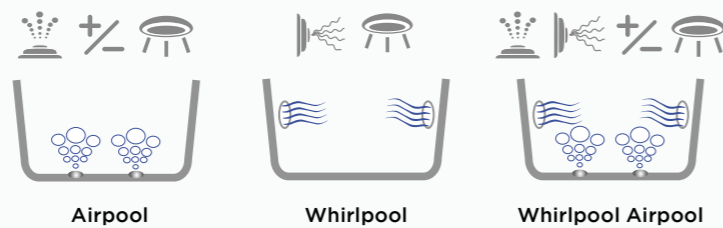

### RUBINETTERIA TAPS

#### Modelli\_ Bolla Sfiore - Bolla con E.T.P.

Models\_ Bolla Sfiore - Bolla with water filling from overflow



#### LOFT A1

Mix due fori con E.T.P.  
Mix two holes with water filling from overflow

#### LOFT A2

Mix quattro fori con E.T.P.  
Mix four holes with water filling from overflow

#### PRESTIGE A1

Mix tre fori con E.T.P.  
Mix three holes with water filling from overflow

#### PRESTIGE A2

Mix quattro fori con E.T.P.  
Mix four holes with water filling from overflow



#### Modelli\_ Bolla Ø 160, Bolla R 162x112, Bolla Q 160

Models\_ Bolla Ø 160, Bolla R 162x112, Bolla Q 160



#### LOFT B1

Mix due fori con bocca di erogazione  
Mix two holes with water spout

#### LOFT B2

Mix tre fori con bocca di erogazione  
Mix three holes with water spout

#### PRESTIGE B1

Mix due fori con bocca di erogazione  
Mix two holes with water spout

#### PRESTIGE B2

Mix tre fori con bocca di erogazione  
Mix three holes with water spout

### FINITURE PANNELLI PANELS FINISHES

Bolla Sfiore Ø 190 versione tonda  
Bolla Sfiore Ø 190 round version

#### di serie

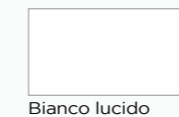

Bianco lucido

#### optional Ecomalta



Bianco

Terra

Grigio Chiaro

Grigio Scuro

Bolla Sfiore Q 190 Bolla Sfiore R 200x150 versione quadrata e rettangolare

Bolla Sfiore Q 190 Bolla Sfiore R 200x150 square and rectangular version

#### di serie

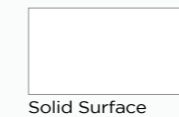

Solid Surface

#### optional Fenix



Grigio Efeso

Grigio Bromo

Grigio Londra

# FOR ALL

design Franco Bertoli

**PRODOTTO FUORI PRODUZIONE**  
**COME DA CIRCOLARE N.11 - AGGIORNAMENTO LISTINI 12/11/2021**

Vasca idromassaggio  
 con porta battente per chi cerca  
 la comodità nel quotidiano.

*Hydromassage tub with hinged door  
 for comfort in everyday life.*



**PRODOTTO FUORI PRODUZIONE**  
**COME DA CIRCOLARE N.11 - AGGIORNAMENTO LISTINI 12/11/2021**



# For All

design  
Franco Bertoli

**PRODOTTO FUORI PRODUZIONE**  
COME DA CIRCOLARE N.11 - AGGIORNAMENTO LISTINI 12/11/2021

**DIM**  
180:

**CAF**  
vasc  
chiusura (con porta battente)  
in cristallo di sicurezza  
12 iniettori airpool  
8 getti whirlpool  
faro subacqueo  
air clean system  
massaggio microdiffuso  
elettrosoffiante a velocità regolabile  
igienizzazione impianto whirlpool  
sensore di livello  
colonna di scarico  
sifone scarico  
programma pulsato

**DIMENSIONS**  
180x78/83 LH corner

**SPECIFICATIONS**  
whirlpool airpool tubs  
crystal glass shutter door  
12 airpool jets  
8 whirlpool jets  
underwater light  
air clean system  
micro-diffused massage electric-blower  
with adjustable speed  
whirlpool disinfection system  
level sensor  
drain column  
trap drain  
pulsed program



**PRODOTTO FUORI PRODUZIONE**  
COME DA CIRCOLARE N.11 - AGGIORNAMENTO LISTINI 12/11/2021

# MODE

collection

Le vasche Mode, dalle linee moderne e dalle dimensioni ottimali, sono pratiche e funzionali. Nella versione 190x80 la pannellatura è dotata di pratici vani porta oggetti.

*The Mode bathtubs, with modern lines and optimal dimensions, are practical and functional. In the 190x80 version, the paneling is equipped with practical storage compartments.*

*Misure disponibili*  
*Available sizes*

190x80 180x90 170x80 180x75 160x90/70



**DIMENSIONI**  
190x80 cm

**DIMENSIONS**  
190x80 cm



# Mode

collection

## DIMENSIONI

180x90 cm

## CARATTERISTICHE

vasca digitale whirlpool  
8 getti whirlpool  
igienizzazione impianto whirlpool  
faro subacqueo  
colonna scarico  
sifone scarico  
sensore di livello  
programma pulsato  
massaggio microdiffuso  
con elettrosffiante  
a velocità regolabile  
air clean system

## DIMENSIONS

180x90 cm

## SPECIFICATIONS

digital whirlpool bath  
8 whirlpool jets  
whirlpool disinfection system  
underwater spotlight  
drain pipe with trap  
trap drain  
level sensor  
airpool pulsed program  
micro-diffused massage  
by electro-blower with  
adjustable speed  
air clean system



180x90 cm digitale DX \_ RH digital



180x75 cm airpool SX \_ LH airpool

**DIMENSIONI**  
180x75 cm

**CARATTERISTICHE**  
vasca digitale airpool  
16 iniettori airpool  
programma pulsato  
massaggio  
microdiffuso con  
elettrosoffiante  
a velocità regolabile

faro subacqueo  
air clean system  
sensore di livello  
colonna scarico  
sifone scarico

**DIMENSIONS**  
180x75 cm

**SPECIFICATIONS**  
airpool digital  
bathtub  
16 airpool jets  
airpool pulsed  
program

*micro-diffused massage  
by electro-blower with  
adjustable speed  
underwater light  
air clean system  
level sensor  
overflow column  
trap drain*



160x90/70 cm airpool DX \_ RH airpool

**DIMENSIONI**  
160x90/70 cm

**CARATTERISTICHE**  
vasca digitale airpool  
16 iniettori airpool  
programma pulsato

massaggio  
microdiffuso con  
elettrosoffiante  
a velocità regolabile  
faro subacqueo  
air clean system  
sensore di livello  
colonna scarico  
sifone scarico

**DIMENSIONS**  
160x90/70 cm

**SPECIFICATIONS**  
airpool digital  
bathtub  
16 airpool jets  
airpool pulsed  
program

*micro-diffused massage  
by electro-blower with  
adjustable speed  
underwater light  
air clean system  
level sensor  
overflow column  
trap drain*

# ERA PLUS ERA

collection

Design e dimensioni diverse: le vasche idromassaggio Era si adattano ad ogni spazio e riservano un'esperienza totale di comfort, che unisce alla tecnologia whirlpool ed airpool i benefici della cromoterapia e dell'ozonoterapia.

Il comodo cuscino Life completa lo stile e la comodità.

Disponibile anche in finitura Acrilico opaco, esclusa Era 140x140.

*Different design and dimensions: Era whirlpool tubs adapt to any space and reserve a total experience of comfort, which combines whirlpool and airpool technology with the benefits of chromotherapy and ozone therapy.*

*The comfortable Life cushion completes the style and comfort.*

*Also available in matt acrylic finish, except Era 140x140.*

**Il benessere si esprime in tante forme.**

*Wellness in many forms.*





## Era plus

collection

Disponibile anche in finitura Acrilico opaco  
Also available in matt Acrylic finish

### DIMENSIONI

200x120 cm

### CARATTERISTICHE

professional whirlpool  
airpool - incasso  
vasca digitale  
8 getti whirlpool  
24 iniettori airpool  
intensità idromassaggio  
whirlpool regolabile  
programma pulsato airpool  
massaggio microdiffuso  
con elettrosffiante a  
velocità regolabile  
ozonoterapia con  
riscaldatore e regolazione  
della temperatura  
air clean system  
igienizzazione impianto  
whirlpool  
faro subacqueo  
sensore di livello  
colonna scarico  
sifone scarico

### DIMENSIONS

200x120 cm

### SPECIFICATIONS

professional whirlpool  
airpool - built-in  
digital bathtub  
8 whirlpool jets  
whirlpool  
24 airpool jets  
adjustable whirlpool  
hydromassage intensity  
pulsed airpool program  
micro-diffused massage  
by electro-blower with  
adjustable speed  
ozonotherapy with heater  
and temperature regulation  
air clean system  
disinfection system  
underwater light  
level sensor  
drain column  
trap drain

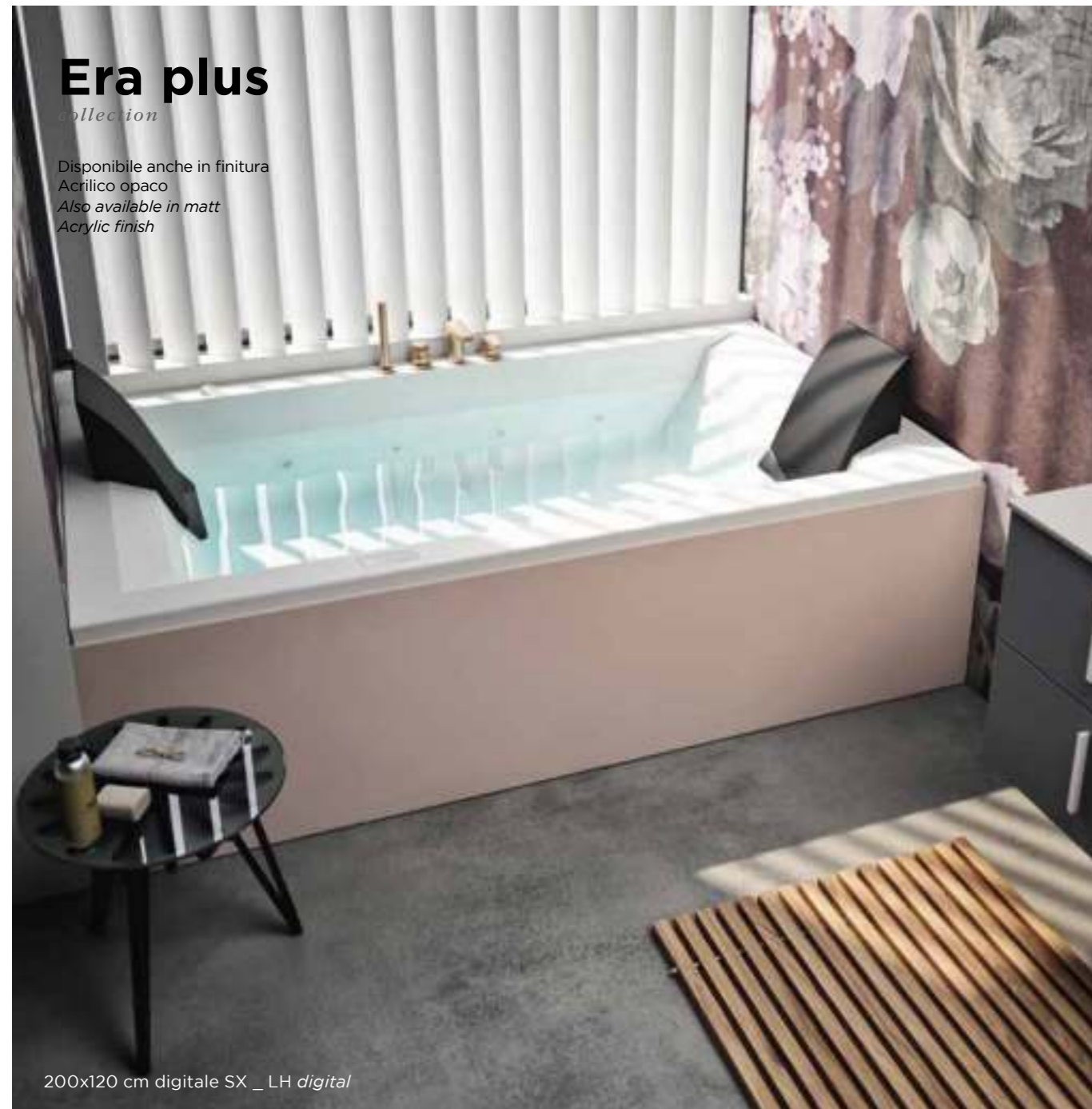

**DIMENSIONI**  
200x120 cm

**CARATTERISTICHE**  
vasca digitale  
8 getti whirlpool  
igienizzazione  
impianto whirlpool  
faro subacqueo  
sensore di livello  
colonna scarico  
sifone scarico

**DIMENSIONS**  
200x120 cm

**SPECIFICATIONS**  
*digital bathtub*  
*8 whirlpool jets*  
*whirlpool*  
*disinfection system*  
*underwater light*  
*level sensor*  
*drain column*  
*trap drain*

**DIMENSIONI**  
180x120/70 cm

**CARATTERISTICHE**  
vasca digitale  
8 getti whirlpool  
igienizzazione  
impianto whirlpool  
faro subacqueo  
sensore di livello  
colonna scarico  
sifone scarico

**DIMENSIONS**  
180x120/70 cm

**SPECIFICATIONS**  
*digital bathtub*  
*8 whirlpool jets*  
*whirlpool*  
*disinfection system*  
*underwater light*  
*level sensor*  
*drain column*  
*trap drain*

## Era

collection

Non disponibile in finitura  
Acrilico opaco  
Not available in matt  
Acrylic finish



140x140 cm airpool

### DIMENSIONI

140x140 cm

### CARATTERISTICHE

vasca digitale airpool  
16 iniettori airpool  
programma  
pulsato airpool  
massaggio  
microdiffuso con  
elettrosoffiante a  
velocità regolabile

faro subacqueo  
air clean system  
sensore di livello  
colonna scarico  
sifone scarico

### DIMENSIONS

140x140 cm

### SPECIFICATIONS

airpool bathtub  
16 airpool jets  
airpool pulsed program  
micro-diffused  
massage  
electro-blower with  
adjustable speed  
underwater light

air clean system  
level sensor  
drain column  
trap drain

## Era plus

collection

Disponibile anche in finitura  
Acrilico opaco  
Also available in matt  
Acrylic finish



190x90 cm  
professional whirlpool airpool

### DIMENSIONI

190x90 cm  
professional whirlpool  
airpool

### CARATTERISTICHE

professional whirlpool  
airpool - incasso  
vasca digitale  
8 getti whirlpool  
24 iniettori airpool  
intensità idromassaggio  
whirlpool regolabile  
programma pulsato  
airpool

massaggio microdiffuso  
con elettrosoffiante  
a velocità regolabile  
ozonoterapia con  
riscaldatore e  
regolazione della  
temperatura  
air clean system  
igienizzazione  
impianto whirlpool  
faro subacqueo  
sensore di livello  
colonna scarico  
sifone scarico

### DIMENSIONS

190x90 cm  
professional whirlpool  
airpool

### SPECIFICATIONS

professional whirlpool  
airpool - built-in  
digital bathtub  
8 whirlpool jets  
whirlpool  
24 airpool jets  
adjustable whirlpool  
hydromassage  
intensity

pulsed airpool program  
micro-diffused  
massage  
by electro-blower with  
adjustable speed  
ozonotherapy  
with heater and  
temperature regulation  
air clean system  
disinfection system  
underwater light  
level sensor  
drain column  
trap drain

# EVA

collection

Il design lineare e moderno di Eva si arricchisce di tante funzionalità pensate per offrire il massimo del benessere a corpo e mente.  
La vasca può essere personalizzata con pannelli di diverse finiture e colori.

*The linear and modern design of Eva is enriched with many features designed to offer maximum well-being to body and mind. The bathtub can be customized with side panels in different finishes and colours.*

**Piccoli mondi in cui abbandonarsi  
al relax per rigenerarsi.**

*Different ways in which to indulge  
in relaxation to regenerate.*



# Eva

collection

## DIMENSIONI

180x80 cm sx

## CARATTERISTICHE

vasca digitale airpool  
16 iniettori airpool  
programma  
pulsato airpool  
massaggio microdiffuso  
con elettrosoffiante a  
velocità regolabile  
faro subacqueo  
air clean system  
sensore di livello  
colonna scarico  
sifone scarico

## DIMENSIONS

180x80 cm left

## SPECIFICATIONS

airpool bathtub  
16 airpool jets  
airpool pulsed program  
micro-diffused massage  
electro-blower with  
adjustable speed  
underwater light  
air clean system  
level sensor  
drain column  
trap drain



# Eva

collection

## DIMENSIONI

170x70 cm

## CARATTERISTICHE

vasca digitale airpool  
16 iniettori airpool  
programma pulsato  
massaggio microdiffuso  
con elettrosffiante a  
velocità regolabile  
faro subacqueo  
air clean system  
sensore di livello  
colonna scarico  
sifone scarico in plastica

## DIMENSIONS

170x70 cm

## SPECIFICATIONS

airpool digital  
bathtub  
16 airpool jets  
pulsed program  
micro-diffused massage  
by electro-blower with  
adjustable speed  
underwater light  
air clean system  
level sensor  
drain column  
trap plastic drain



# Zaphiro

collection



200x100 cm digitale \_ digital

**DIMENSIONI**  
200x100 cm

**SISTEMI**  
whirlpool  
digitale  
airpool  
whirlpool / airpool  
professional  
whirlpool / airpool

**CARATTERISTICHE**  
vasca digitale  
6 getti whirlpool  
igienizzazione  
impianto whirlpool  
faro subacqueo  
sensore di livello  
sifone scarico  
colonna di scarico

**DIMENSIONS**  
200x100 cm

**SYSTEM**  
whirlpool  
digital  
airpool  
whirlpool / airpool  
professional  
whirlpool / airpool

**SPECIFICATIONS**  
digital bathtub  
6 whirlpool jets  
whirlpool  
disinfection system  
underwater light  
level sensor  
trap drain  
overflow column with  
communicating vessels

# Oasy

collection



195x115 cm airpool

**DIMENSIONI**  
195x115 cm

**SISTEMI**  
whirlpool  
digitale  
airpool  
whirlpool / airpool  
professional  
whirlpool / airpool

**CARATTERISTICHE**  
vasca airpool  
20 iniettori airpool  
faro subacqueo  
sensore di livello  
sifone  
colonna di scarico

**DIMENSIONS**  
195x115 cm

**SYSTEM**  
whirlpool  
digital  
airpool  
whirlpool / airpool  
professional  
whirlpool / airpool

**SPECIFICATIONS**  
airpool bathtub  
20 airpool jets  
underwater light  
level sensor  
drain  
overflow column

## Duo

collection



170x65/78 cm a parete \_ wall

**DIMENSIONI**  
170x65/78 cm

**SISTEMI**  
whirlpool  
digitale  
airpool  
whirlpool airpool

**CARATTERISTICHE**  
vasca con telaio  
colonna scarico  
sifone scarico

**DIMENSIONS**  
170x65/78 cm

**SYSTEM**  
whirlpool  
digitale  
airpool  
whirlpool airpool

**SPECIFICATIONS**  
bathtub with  
supporting frame  
overflow column  
trap drain

## Ondaria

collection



180x80 cm whirlpool / airpool a parete \_ wall

**DIMENSIONI**  
180x80 \_ 170x70/75 cm

**SISTEMI**  
whirlpool  
digitale  
airpool  
whirlpool airpool  
professional  
whirlpool airpool

**CARATTERISTICHE**  
vasca digitale whirlpool  
/airpool con 6 getti  
whirlpool e  
12 iniettori airpool  
programma pulsato  
massaggio microdiffuso  
con elettrosoffiante a  
velocità regolabile  
faro subacqueo

igenizzazione impianto  
whirlpool

air clean system  
sensore di livello  
colonna scarico  
sifone scarico

**DIMENSIONI**  
180x80 \_ 170x70/75 cm

**SISTEMI**  
whirlpool  
digitale  
airpool  
whirlpool airpool  
professional  
whirlpool airpool

**CARATTERISTICHE**  
whirlpool / airpool  
digital bathtub with 6  
whirlpool jets e  
12 airpool injectors  
pulsed program  
micro-diffused massage  
with adjustable speed  
air blower  
underwater light

whirlpool system  
sanitation

air clean system  
level sensor  
drain column  
drain siphon



# Gamma

collection



170x70/76 cm airpool ad incasso SX \_ digital built-in LH

**DIMENSIONI**  
170x70/76 cm

**SISTEMI**  
whirlpool  
digitale  
airpool  
whirlpool airpool  
professional  
whirlpool airpool

**CARATTERISTICHE**  
vasca airpool  
faro subacqueo  
sensore di livello  
colonna scarico  
sifone scarico

**DIMENSIONS**  
170x70/76 cm

**SYSTEM**  
whirlpool  
digitale  
airpool  
whirlpool airpool  
professional  
whirlpool airpool

**SPECIFICATIONS**  
airpool bathtub  
underwater light  
level sensor  
overflow column  
trap drain

# Igloo

collection



160x60 cm whirlpool-airpool

**DIMENSIONI**  
160x160 cm

**SISTEMI**  
whirlpool  
digitale  
airpool  
whirlpool airpool  
professional  
whirlpool airpool

**CARATTERISTICHE**  
vasca digitale  
8 getti whirlpool  
15 iniettori airpool  
programma pulsato  
massaggio microdiffuso  
con elettrosoffiante a  
velocità regolabile  
igieniz. impianto whirlpool  
air clean system  
faro subacqueo  
sensore di livello  
colonna scarico  
sifone scarico

**DIMENSIONI**  
160x160 cm

**SISTEMI**  
whirlpool  
digitale  
airpool  
whirlpool airpool  
professional  
whirlpool airpool

**CARATTERISTICHE**  
digital bathtub  
8 whirlpool jets  
15 airpool jets  
pulsed program  
micro-diffused massage  
by electro-blower with  
adjustable speed  
whirlpool disinfection system  
air clean system  
underwater light  
level sensor  
overflow column  
trap drain

**Ego**  
collection



150x150 cm airpool

**DIMENSIONI**  
150x150 cm

**SISTEMI**  
whirlpool  
digitale  
airpool  
whirlpool airpool  
professional  
whirlpool airpool

**CARATTERISTICHE**

vasca digitale airpool  
20 iniettori airpool  
programma pulsato  
massaggio microdiffuso  
con elettrosoffiante  
a velocità regolabile  
faro subacqueo  
air clean system  
sensore di livello  
colonna scarico  
sifone scarico

**DIMENSIONS**  
150x150 cm left

**SYSTEM**  
whirlpool  
digitale  
airpool  
whirlpool airpool  
professional  
whirlpool airpool

**SPECIFICATIONS**

airpool digital bathtub  
20 airpool jets  
pulsed program  
micro-diffused massage  
by electro-blower with  
adjustable speed  
underwater light spot  
air clean system  
level sensor  
overflow column  
trap drain

**Diva**  
collection



140x140 cm airpool

**DIMENSIONI**  
140x140 cm

**SISTEMI**  
whirlpool  
digitale  
airpool  
whirlpool airpool  
professional  
whirlpool airpool

**CARATTERISTICHE**

vasca digitale airpool  
12 iniettori airpool  
programma pulsato  
massaggio microdiffuso  
con elettrosoffiante  
a velocità regolabile  
air clean system  
faro subacqueo  
sensore di livello  
colonna scarico  
sifone scarico

**DIMENSIONI**  
140x140 cm

**SISTEMI**  
whirlpool  
digitale  
airpool  
whirlpool airpool  
professional  
whirlpool airpool

**CARATTERISTICHE**

digital airpool bathtub  
12 airpool jets  
pulsed program  
micro-diffused massage  
by electro-blower with  
adjustable speed  
air clean system  
underwater light spot  
level sensor  
overflow column  
trap drain

# Nova

collection



170x70  
whirlpool-airpool

**DIMENSIONI**

180x80 cm  
170x65/70/80 cm  
160x65/70 cm  
150x70 cm  
140x70 cm  
(esclusa versione  
whirlpool-airpool)  
120x70 cm  
(escluso  
idromassaggio)

**SISTEMI**

whirlpool  
airpool  
whirlpool airpool

**CARATTERISTICHE**

vasca whirlpool digitale  
regolazione aria  
6 idrogetti  
colonna di scarico  
sensore di livello  
sifone scarico

**DIMENSIONS**

180x80 cm  
170x65/70/80 cm  
160x65/70 cm  
150x70 cm  
140x70 cm  
(whirlpool-airpool  
excluded version)  
120x70 cm  
(excluded  
hydromassage)

**SYSTEM**

whirlpool  
airpool  
whirlpool airpool

**SPECIFICATIONS**

whirlpool bathtub  
air regulation  
6 whirlpool jets  
drain column  
level sensor  
trap drain

# Nova

collection



160x100  
whirlpool-airpool SX \_ LH

**DIMENSIONI**

160x100 cm

**SISTEMI**

whirlpool  
airpool  
whirlpool airpool

**CARATTERISTICHE**

vasca whirlpool-airpool  
regolazione aria  
6 idrogetti  
12 iniettori airpool  
colonna scarico  
sonda di livello  
sifone scarico

**DIMENSIONS**

160x100 cm

**SYSTEM**

whirlpool  
airpool  
whirlpool airpool

**SPECIFICATIONS**

whirlpool-airpool bathtub  
air regulation  
6 whirlpool jets  
12 airpool jets  
drain column  
level sensor  
trap drain

# Nova

collection



140x40 cm whirlpool-airpool

NOVA | collection

## DIMENSIONI

140x140 cm  
120x120 cm

## SISTEMI

whirlpool  
airpool  
whirlpool airpool

## CARATTERISTICHE

vasca digitale  
whirlpool airpool  
6 idrogetti  
12 iniettori airpool  
colonna scarico  
sonda di livello  
sifone scarico

## DIMENSIONS

140x140 cm  
120x120 cm

## SYSTEM

whirlpool  
airpool  
whirlpool airpool

## SPECIFICATIONS

digital bathtub  
whirlpool airpool  
6 whirlpool jets  
12 airpool jets  
drain column  
level sensor  
trap drain

# Nova plus

collection



140x40 cm whirlpool-airpool

NOVA | collection

## DIMENSIONI

140x140 cm

## SISTEMI

whirlpool  
airpool  
whirlpool airpool

## CARATTERISTICHE

vasca digitale  
whirlpool airpool  
6 idrogetti  
12 iniettori airpool  
colonna scarico  
sonda di livello  
sifone scarico

## DIMENSIONS

140x140 cm

## SYSTEM

whirlpool  
airpool  
whirlpool airpool

## SPECIFICATIONS

digital bathtub  
whirlpool airpool  
6 whirlpool jets  
12 airpool jets  
drain column  
level sensor  
trap drain

# Old Time

collection



170x80 cm

OLD TIME | collection

## DIMENSIONI

170x80 cm

## CARATTERISTICHE

vasca con piedini  
colonna scarico con sifone  
piantana a pavimento  
gruppo vasca tipo antico  
manopola croce

## DIMENSIONS

170x80 cm

## SPECIFICATIONS

tub with feet  
drain column and siphon  
pedestal on floor  
bath group antique style  
with cross knobs

# VASCHE COMBinate

WASHTUBS WITH CRYSTAL  
GLASS SHOWER CABIN

For All box <sup>408</sup>

Era Plus box <sup>410</sup>

Duo box <sup>412</sup>

Nova box <sup>414</sup>

  
**HAFRO**  
acqua, per piacere

## For All box

collection



Vasca combinata  
Tubs with cabin



Vasca  
Bathtub



Apertura totale per  
facilitare l'accesso  
Total opening for  
easy access

### PRODOTTO FUORI PRODUZIONE

COME DA CIRCOLARE N.11 - AGGIORNAMENTO LISTINI 12/11/2021

**DIM**  
180:

**INSTALLAZIONE**  
angolo

**SISTEMI**  
digitale  
airpool  
whirlpool airpool

**MEASUREMENT**  
180x78/83 RH-LH

**INSTALLATION**  
corner

**SYSTEM**  
digitale  
airpool  
whirlpool airpool

chiusura (con porta battente)  
in cristallo di sicurezza  
12 iniettori airpool  
8 getti whirlpool  
faro subacqueo  
asta doccia con doccetta (optional)  
miscelatore a muro (optional)  
air clean system  
programma pulsato  
massaggio microdiffuso  
elettrosoffiante a velocità regolabile  
igienizzazione impianto whirlpool  
sensore di livello  
sifone scarico  
kit profilo bordo vasca

**SPECIFICATIONS**  
whirlpool airpool tub  
crystal glass shutter door  
12 airpool jets  
8 whirlpool jets  
underwater light  
shower rod with handshower (optional)  
mixer tap (optional)  
air clean system  
pulsed program  
micro-diffused massage electric-blower  
with adjustable speed  
whirlpool disinfection system  
level sensor  
trap drain  
bowl edge profile kit

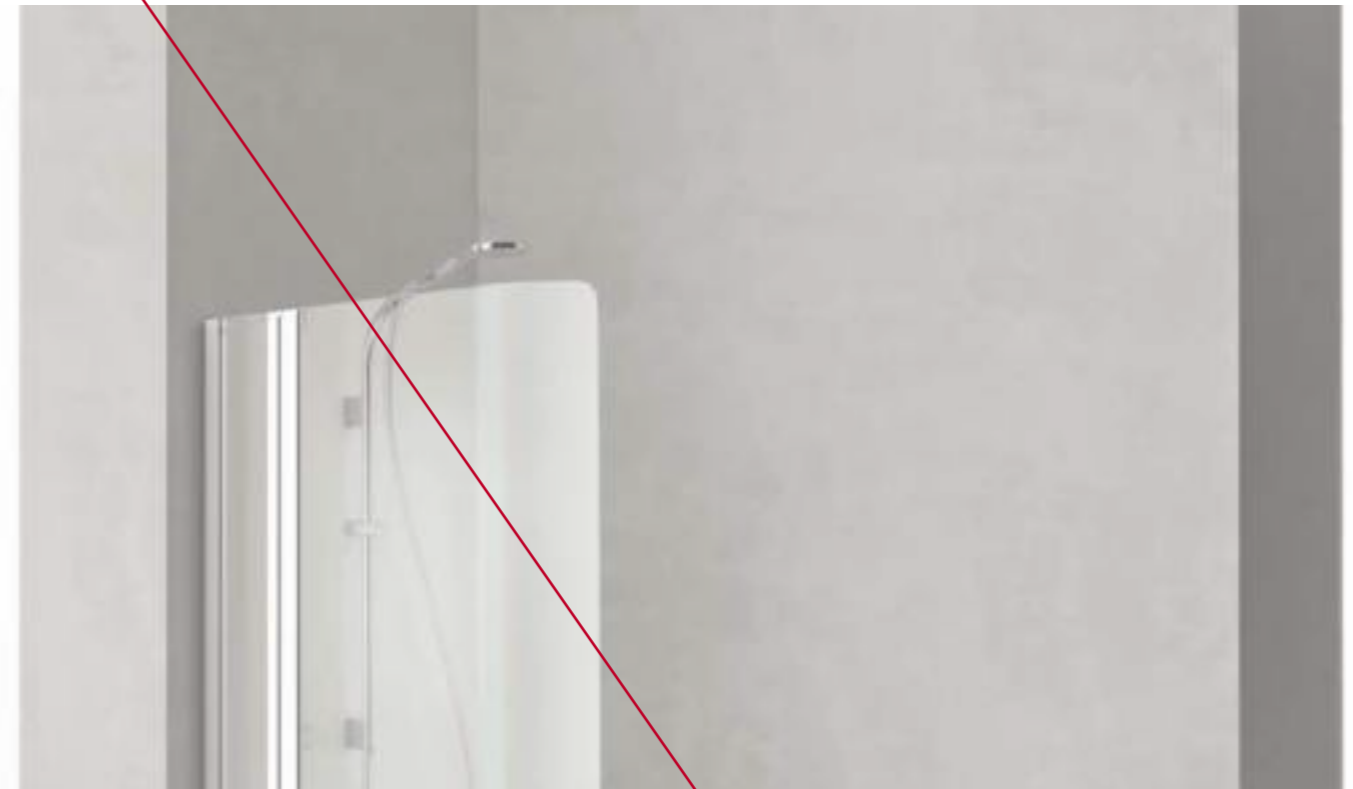

### PRODOTTO FUORI PRODUZIONE

COME DA CIRCOLARE N.11 - AGGIORNAMENTO LISTINI 12/11/2021



180x78/83 cm sx whirlpool airpool

# Era plus box

collection

## DIMENSIONI

### ERA BOX

170x70 dx-sx  
170x75 dx-sx

### ERA PLUS BOX

180x80 dx-sx  
190x90 dx-sx  
180x120/70 dx-sx

## INSTALLAZIONE

angolo-parete

## SISTEMI

whirlpool  
digitale  
airpool  
whirlpool airpool  
professional  
whirlpool airpool  
(solo Era Plus Box)

## MEASUREMENT

### ERA BOX

170x70 rh-lh  
170x75 rh-lh

### ERA PLUS BOX

180x80 rh-lh  
190x90 rh-lh  
180x120/70 rh-lh

## INSTALLATION

corner-wall

## SYSTEM

whirlpool  
digital  
airpool  
whirlpool airpool  
professional  
whirlpool airpool  
(only Era Plus Box)

## CARATTERISTICHE

vasca digitale  
whirlpool airpool  
8 getti whirlpool  
12 iniettori airpool  
programma pulsato  
airpool  
massaggio  
microdiffuso con  
elettrosoffiante a  
velocità regolabile  
air clean system  
ozonoterapia  
(optional)  
faro subacqueo  
box in cristallo  
completo di colonna  
in acciaio lucido

soffione incorporato  
miscelatore  
termostatico  
deviatore  
erogatore  
doccetta raining  
igienizzazione  
impianto whirlpool  
sensore di livello  
colonna scarico  
sifone scarico



## SPECIFICATIONS

digital bathtub  
whirlpool airpool  
8 whirlpool jets  
12 airpool jets  
pulsed airpool  
program  
micro diffused  
massage with  
electro-blower with  
adjustable speed  
air clean system  
ozonotherapy  
(optional)  
underwater light  
crystal glass cabin  
built-in headshower  
thermostatic tap  
deviator  
spout

handshower rain  
effect  
whirlpool  
disinfection system  
level sensor  
drain column  
trap drain



190X90 cm sx whirlpool airpool

## Duo box

collection

### DIMENSIONI

170x65/78 cm

### INSTALLAZIONE

angolo

### SISTEMI

whirlpool  
digitale  
airpool  
whirlpool airpool

### CARATTERISTICHE

vasca telaio  
colonna di scarico  
kit profilo bordo vasca  
box in cristallo  
completo di colonna  
attrezzata  
miscelatore  
asta doccia con  
doccetta  
deviatore  
erogatore  
idromassaggio  
verticale pulsato 6 getti  
sifone scarico

### MEASUREMENT

170x65/78 cm

### INSTALLATION

corner

### SYSTEM

whirlpool  
digital  
airpool  
whirlpool airpool

### SPECIFICATIONS

frame bathtub  
drain column  
bowl edge profile kit  
shower cabin  
complete of  
equipped column  
mixer  
handshower on slide  
bar  
deviator  
spout  
6 vertical pulsed jets  
trap drain



170x78 cm sx



# Nova box

collection

## DIMENSIONI

140x70 cm  
(solo versione whirlpool)  
150x70 cm  
160x70 cm  
170x80 cm  
180x80 cm

## INSTALLAZIONE

angolo

## SISTEMI

whirlpool  
whirlpool airpool

## CARATTERISTICHE

vasca digitale whirlpool  
6 getti whirlpool  
12 iniettori airpool  
sonda di livello  
colonna di scarico  
box in cristallo di  
sicurezza con 2 pareti  
apribili  
sifone scarico  
colonna  
Quarantacinque C  
(optional)

## MEASUREMENT

140x70 cm  
(only whirlpool version)  
150x70 cm  
160x70 cm  
170x80 cm  
180x80 cm

## INSTALLATION

corner

## SYSTEM

whirlpool  
whirlpool airpool

## SPECIFICATIONS

digital bathtub  
whirlpool  
6 whirlpool jets  
12 airpool jets  
level sensor  
drain column  
shower cabin made  
by safety tempered  
glass with 2 opening  
doors  
trap drain  
shower column 45 C  
(optional)



180x80 sx whirlpool airpool

# Soprasvasca Time

collection

La vasca diventa una pratica doccia con l'aggiunta di pareti fisse o mobili. Puoi scegliere in libertà tra un bagno rilassante o una doccia rigenerante.

*Bathtubs become practical showers with the addition of fixed or movable walls. You can choose freely between a relaxing bath or a regenerating shower.*



2 porte battente  
2 hinged door



parete fissa + porta  
fixed side + door



parete fissa  
fixed side



# RUBINETTERIA FINITURE TASTIERE

---

TAPS  
FINISHES  
DISPLAY PANELS

# RULE COLLECTION

Da elemento puramente funzionale a complemento decorativo che completa l'arredo bagno: la rubinetteria impreziosisce lavabi, bidet e vasche con forme sempre più accattivanti e colorazioni di tendenza. Dal design di Hafro nasce Rule, una collezione completa disponibile in Cromo, Nero, Rosa e Acciaio per avere in tutto l'ambiente bagno una rubinetteria coordinata nello stile e nella tonalità.

*From a purely functional element to a decorative complement that completes the bathroom furnishings: the taps embellish sinks, bidets and bathtubs with captivating shapes and trendy colours. Rule is a complete collection available in Chrome, Black, Pink and Steel, studied in detail from Hafro to have coordinated taps throughout your bathroom.*

**Disponibile per:**  
Vasca  
Mix Bidet  
Mix basso, medio, alto  
Mix a parete

**Available for:**  
Bathtub  
Bidet mix  
Low, medium, high mix  
Wall mix



## FINITURE FINISHES



**Cromo**  
Chrome

**Nero**  
Black

**Rosa**  
Pink

**Acciaio**  
Steel

# RULE<sup>High</sup>



**FINITURE**  
acciaio e rosa

**FINISHES**  
steel and pink



# RULE<sup>Mid</sup>

Il lucido brillante del Cromo o l'effetto opaco del Nero completano e caratterizzano il bagno con due personalità distinte.

*The glossy effect of chrome or the opaque shade of black characterize the bathroom with two distinct personalities.*



---

**FINITURE**  
nero e cromo

**FINISHES**  
black and chrome



# RULE<sup>Mid</sup>

Nella versione media, Rule si adatta sia ai lavabi in appoggio sia ai lavabi integrati nel top. Il design minimal è all'altezza di ogni stile di arredo.

*In the medium version, Rule adapts to both countertop washbasins and built-in washbasins. The minimal design matches any furnishing style.*



**FINITURE**  
nero e cromo

**FINISHES**  
black and chrome





## RULE<sup>Low</sup>

Nella versione bassa, Rule è perfetto per tutti i lavabi integrati nel top, in particolare per le soluzioni salvaspazio. Cambia l'altezza, ma la funzionalità rimane invariata.

*In the low version, Rule is perfect for all built-in washbasins, in particular for space-saving solutions. Height changes, but functionality remains the same.*

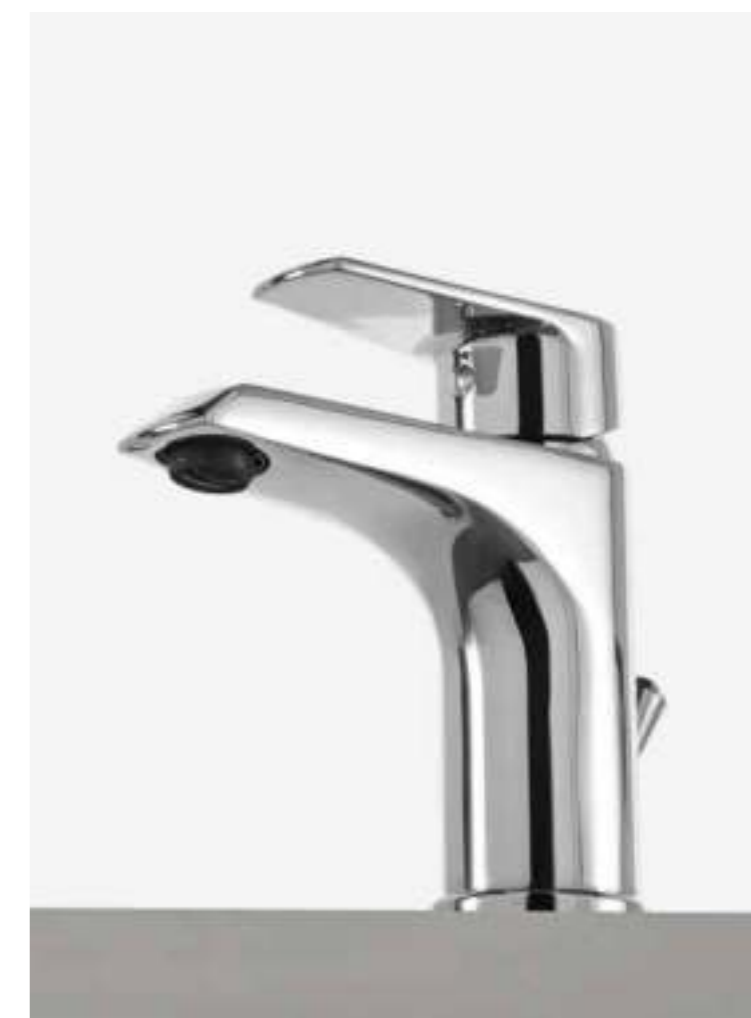

**FINITURE**  
cromo

**FINISHES**  
chrome



# RULE<sup>Wall</sup>

In finitura opaca Nero,  
Rule si abbina alla mensola in metallo  
nella tonalità e nelle forme.

*In the Black matte finish, Rule matches  
the metal shelf in shades and shapes.*

FINITURE  
nero

FINISHES  
black



# RULE<sup>Bidet</sup>



**FINITURE**  
acciaio

**FINISHES**  
steel



**FINITURE**  
cromo

**FINISHES**  
chrome

## RULE<sup>Tub</sup>

Nella versione per vasca, Rule è composto da rubinetto, miscelatore, deviatore e doccia: più elementi per uno stile unico firmato Hafro.

*In the version for the bathtub, Rule is composed by tap, mixer, diverter and hand shower: more elements for a unique style designed by Hafro.*

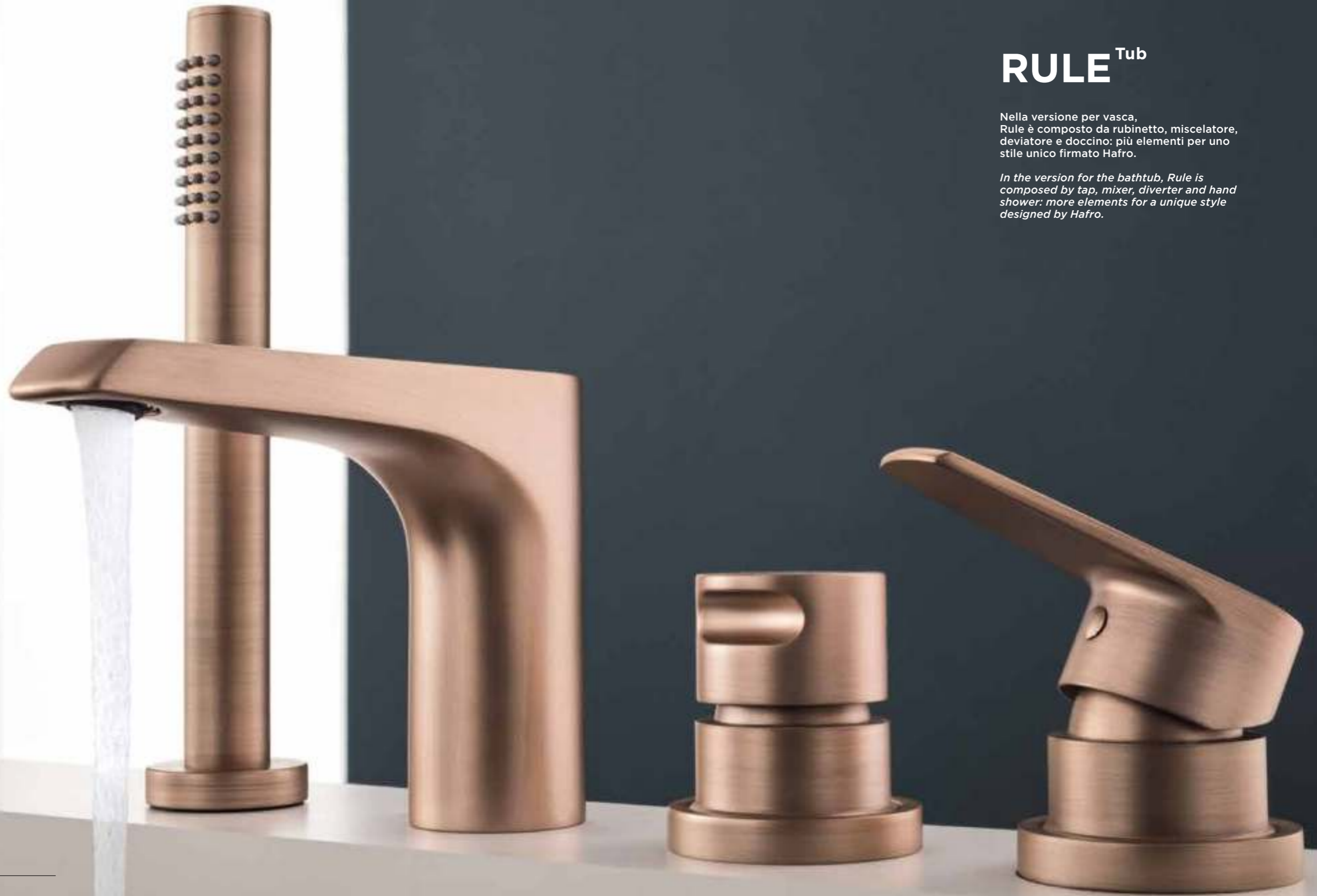

**FINITURE**  
rosa

**FINISHES**  
pink

# RULE



**Cromo**  
*Chrome*



**Rosa**  
*Pink*



**Nero**  
*Black*



**Acciaio satinato**  
*Satin steel*

## Rubinetteria per vasche

Taps for tubs

Forme cilindriche o squadrate. Le due linee di rubinetteria coordinata esprimono con un design moderno e raffinato due diversi concetti estetici, due scuole di pensiero per interpretare la vasca con il proprio gusto, a quattro o tre fori.

*Cylindrical or square shapes. According with their modern and sophisticated design, with four or three holes, they express two different aesthetical concepts, two schools of thought to interpret the tub with a proper own taste.*



sistema antigoccia  
drip-proof system

Modelli \_ Bolla Sfiore - Bolla con E.T.P.

Models\_ Bolla Sfiore - Bolla with water filling from overflow



**LOFT A1**

Mix due fori  
con E.T.P.

Mix two holes  
with water filling  
from overflow



**LOFT A2**

Mix quattro fori  
con E.T.P.

Mix four holes  
with water filling  
from overflow



**PRESTIGE A1**

Mix tre fori  
con E.T.P.

Mix three holes  
with water filling  
from overflow



**PRESTIGE A2**

Mix quattro fori  
con E.T.P.

Mix four holes  
with water filling  
from overflow



**PIANTANA**  
Pedestal

Modelli \_ Bolla Ø 160, Bolla R 162x112, Bolla Q 160

Models\_ Bolla Ø 160, Bolla R 162x112, Bolla Q 160



**LOFT B1**

Mix due fori +  
bocca di erogazione  
Mix two holes  
+ water spout



**LOFT B2**

Mix tre fori +  
bocca di erogazione  
Mix three holes  
+ water spout



**PRESTIGE B1**

Mix due fori +  
bocca di erogazione  
Mix two holes  
+ water spout



**PRESTIGE B2**

Mix tre fori +  
bocca di erogazione  
Mix three holes  
+ water spout

## Rubinetteria Taps

Modello \_ Nova  
Model\_ Nova



**REAL mod. E**

Mix tre fori  
+ E.T.P.

Mix three holes  
+ water filling from  
overflow

**REAL mod. F**

Mix tre fori +  
bocca di erogazione

Mix three holes  
+ water spout

Modelli \_ Sensual  
Models\_ Sensual



**LOFT B1**

Mix tre fori +  
bocca di erogazione

Mix three holes  
+ water spout

**LOFT B2**

Mix quattro fori +  
bocca di erogazione

Mix four holes  
+ water spout

Modello: Move, Skill-Up, Skill

Model: Move, Skill-Up, Skill



**PIANTANA QUADRA**

Con bocca  
di erogazione

Square pedestal  
with water spout

**PIANTANA TONDA**

Con bocca  
di erogazione

Round pedestal  
with water spout

## Rubinetteria QUADRA Square taps

Modelli: Mode, Era  
Models: Mode, Era

Modelli:Rio  
Models: Rio



**LOFT A1**

Mix tre fori  
con E.T.P.

Mix three holes  
with water filling  
from overflow

**LOFT A2**

Mix quattro fori  
con E.T.P.

Mix four holes  
with water filling  
from overflow



**LOFT B1**

Mix tre fori +  
bocca di erogazione  
a cascata

Mix three holes  
+ water spout  
with water cascade



**LOFT B2**

Mix quattro fori +  
bocca di erogazione  
a cascata

Mix four holes  
+ water spout  
with water cascade

## Rubinetteria TONDA

### Round taps

**Modelli:** Zaphiro, Oasy, Eva, Ondaria, Gamma, Igloo, Ego, Diva.  
**Models:** Zaphiro, Oasy, Eva, Ondaria, Gamma, Igloo, Ego, Diva.



#### PRESTIGE A1

Mix tre fori  
con E.T.P.  
*Mix three holes  
with water filling  
from overflow*

**Modello:** Duo (cromo)  
**Model:** Duo (chrome)

#### PRESTIGE A2

Mix quattro fori  
con E.T.P.  
*Mix four holes  
with water filling  
from overflow*

**Modello:** Minerva (cromo e nero)  
**Model:** Minerva (chrome and black)



#### PRESTIGE B1

Mix tre fori +  
bocca di erogazione  
*Mix three holes  
+ water spout*

**Modello:** Duo (cromo)  
Calle, Rio (cromo e nero)  
**Model:** Duo (chrome)  
Calle, Rio (chrome and black)

#### PRESTIGE B2

Mix quattro fori +  
bocca di erogazione  
*Mix four holes  
+ water spout*

**Modello:** Minerva  
Calle, Rio (cromo e nero)  
**Model:** Minerva  
Calle, Rio (chrome and black)

**Modello:** Minerva \_ Rubinetteria termostatica 1 via  
**Model:** Minerva \_ Thermostatic mixer 1-way



Miscelatore  
termostatico a 1 + 5 vie  
*1+5 ways  
thermostatic mixer*

## Rubinetteria RULE A1

### Rule A1 taps

**Modelli:** Mode, Era, Eva, Zaphiro, Oasy, Duo, Ondaria, Gamma, Igloo, Ego, Diva, Nova  
**Models:** Mode, Era, Eva, Zaphiro, Oasy, Duo, Ondaria, Gamma, Igloo, Ego, Diva, Nova



Mix tre fori (necessita di E.T.P.) flessibile doccetta con sistema antigoccia  
*Mix three holes (requires dispenser for overflow) flexible hose with anti-drip system*



**Cromo**  
Chrome

**Nero**  
Black

**Rosa**  
Pink

**Acciaio satinato**  
Satin steel

## Rubinetteria RULE B1

### Rule B1 taps

**Modelli:** Rio, Calle, Mode, Era, Eva, Zaphiro, Oasy, Duo, Ondaria, Gamma, Igloo, Ego, Diva, Nova  
**Models:** Rio, Calle, Mode, Era, Eva, Zaphiro, Oasy, Duo, Ondaria, Gamma, Igloo, Ego, Diva, Nova



Mix tre fori con bocca erogazione e flessibile doccetta con sistema antigoccia  
*Mix three holes with water spout and flexible hose with anti-drip system*



**Cromo**  
Chrome

**Nero**  
Black

**Rosa**  
Pink

**Acciaio satinato**  
Satin steel

## Finiture vasche Hafro

Tubs Hafro finishes

**PANNELLI FENIX \_ Modelli: Bolla 190 Q, Bolla 200 R.**  
Fenix panels \_ Models: Bolla 190, Bolla 200 R.



Grigio Efeso    Grigio Bromo    Grigio Londra

Finitura Fenix coordinata con i prodotti Saunavita (OLIMPO - ETHOS C - ETHOS L - GHIBLI SAUNA)  
Fenix finishes matching with Saunavita products (OLIMPO - ETHOS C - ETHOS L - GHIBLI SAUNA)

**PANNELLI SOLID SURFACE \_ Modello: Bolla Q, Bolla R.**  
Solid Surface panels \_ Model: Bolla Q, Bolla R.



Bianco

**PANNELLI ACRILICO \_ Modelli: Nova, Era (esclusa 200x120), Eva, Duo, Ondaria, Gamma, Igloo, Ego Diva, Zaphiro.**  
Acrylic panels \_ Model: Nova, Era (excluded 200x120), Eva, Duo, Ondaria, Gamma, Igloo, Ego Diva, Zaphiro.



Bianco lucido    Bianco opaco

**PANNELLI RIVESTITI IN ACRILICO \_ Modelli: Mode**  
Acrylic coated panels \_ Model: Mode.



Bianco

### PANNELLI RIVESTIBILI IN MOSAICO O PIASTRELLE

Dressable panels with mosaic or tiles

La pannellatura è predisposta per essere rivestita con mosaico o piastrelle, proseguendo così la finitura delle pareti con un suggestivo effetto di continuità. Modelli Eva/Linea Era (esclusa 180x120/70).

The panelling is arranged to be covered with mosaic or tiles, the same of the finishing of the walls with a suggestive effect of continuity. Modelli Eva/Linea Era (excluded 180x120/70).



## Vasche coordinate con l'arredo bagno Geromin

Bathtubs matching the Geromin bathroom furnitures

**PANNELLI LACCATI LUCIDI E OPACHI \_ Modelli: Rio, Sensual, Mode, Minerva, For All, Era, Eva.**  
Glossy and matt lacquered panels \_ Models: Rio, Sensual, Mode, Minerva, For All, Era, Eva.



Bianco    Bianco Perla    Grigio Chiaro    Ghiaccio    Grigio Cenere    Grigio Medio    Grigio Tortora    Grigio Efeso



Grigio Fumo    Grigio Scuro    Grigio Bromo    Nero    Brown    Grigio Londra    Grigio Cosmico    Cashmere



Bianco Panna    Beige Scuro    Marrone    Marsala    Toffee    Miele    Aragosta    Arancio



Giallo    Ocra    Rosso    Ciliegia    Corallo    Cipria    Cielo    Blu Cobalto



Oceano    Petrolio    Salvia    Timo    Menta    Cactus    Verde Oliva    Verde Pistacchio

### VASCHE IN TECNOTEK

Tecnotek tubs

Modelli: Rio, Calle.  
Models: Rio, Calle.

Modello: Move.  
Model: Move.



Bianco    Bianco    Crema    Terra    Grigio Chiaro    Grigio Scuro

**PANNELLI ECOMALTA \_ Modelli: Minerva, Bolla 190Ø.**

Ecomalta panels \_ Models: Minerva, Bolla 190Ø.



Bianco    Terra    Grigio chiaro    Grigio scuro

**COLORATO ACRILICO \_ Modelli: Era 180x120/70**

Colored acrylic \_ Models: Era 180x120/70



Rosso lucido    Nero lucido

**FINITURA VENEZIA OPACO \_ Modelli: Rio**

Venezia matt finishes \_ Models: Rio



Bianco Calacatta opaco    Nero Marquinia opaco

**FINITURA VENEZIA LUCIDO**

Glossy Venice finishes



Bianco Calacatta lucido    Nero Marquinia lucido

# Tastiere per vasche

Display panels for bathtubs



**TASTIERA DIGITALE \_ Modello: Rio.**  
Digital keypad \_ Model: Rio.



**TASTIERA DIGITALE \_ Modelli: Calle, Sensual.**  
Digital keypad \_ Models: Calle, Sensual.

Comandi di accensione e di regolazione dell'idromassaggio airpool integrati nella vasca.  
*The commands to turn on and regulate the airpool hydromassage are integrated into the tub.*

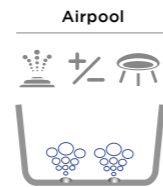

**TASTIERA DIGITALE SENZA RICIRCOLO DELL'ACQUA \_ Modello: Bolla.**  
Digital keypad without water purification system \_ Model: Bolla.

Le funzioni di idromassaggio della versione senza ricircolo d'acqua si attivano direttamente dalla vasca.  
*The hydromassage functions, on versions without water purification systems, can be directly activated from the tub itself.*

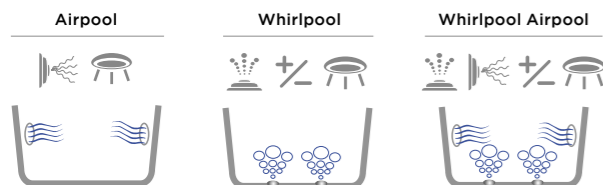

**TASTIERA DIGITALE CON RICIRCOLO DELL'ACQUA \_ Modello: Bolla.**  
Digital keypad with water purification system \_ Model: Bolla.

Dopo l'accensione con il tasto installato nella vasca, tutte le funzioni si controllano comodamente mediante un telecomando.  
*Switch on pressing key built in the tub: every function can be easily controlled using hi-tech remote control.*

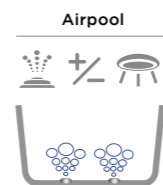

**TASTIERA TOUCH \_ Modello: Minerva.**  
Digital keypad \_ Model: Minerva.

Sistema whirlpool airpool con ricircolo automatico dell'acqua  
*Whirlpool airpool with water recirculation system*

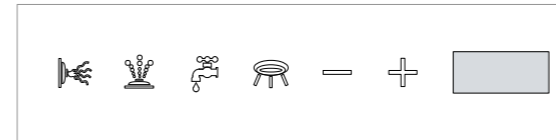

Audio-musica per sistema whirlpool airpool (optional)  
*Audio system with whirlpool airpool system (optional)*

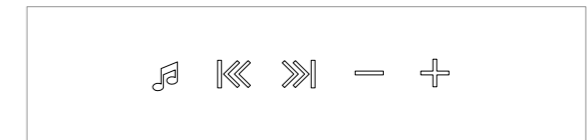

**TASTIERA DIGITALE \_ Modelli: Minerva, Era, Eva, Zaphiro, Oasy, Mode, Duo, Ondaria, Gamma, Igloo, Ego, Diva.**  
Digital keypad \_ Models: Minerva, Era, Eva, Zaphiro, Oasy, Mode, Duo, Ondaria, Gamma, Igloo, Ego, Diva.

Airpool



Whirlpool



Whirlpool Airpool



Professional Whirlpool Airpool



Vasca con Microsilk / Tub with Microsilk



## COMANDO MANUALE

*Mechanic control*

Il comando manuale segue il design delle rubinetterie nella versione cilindrica e quadrata per un perfetto coordinamento.

*The manual command follows the design of the faucet in the cylindrical and square version for a perfect coordination.*



**PRESTIGE**  
Whirlpool on-off con regolazione aria  
*Whirlpool on-off con regolazione aria*



**LOFT**  
Whirlpool on-off con regolazione aria  
*Whirlpool on-off con regolazione aria*

## COMANDO DIGITALE \_ Modello: Nova.

*Digital control \_ Model: Nova.*

Comando digitale Airpool e whirlpool.  
*Airpool and whirlpool digital comand.*



Airpool



Whirlpool



Whirlpool Airpool





# VASCHE AD INCASSO

BUILT-IN BATHTUBS

---

**Bolla** <sup>448</sup>

**Zaphiro** <sup>448</sup>

**Oasy** <sup>448</sup>

**Era Plus** <sup>449</sup>

**Era** <sup>449</sup>

**Mode** <sup>450</sup>

**Eva** <sup>450</sup>

**Duo** <sup>450</sup>

**Ondaria** <sup>451</sup>

**Gamma** <sup>451</sup>

**Igloo** <sup>451</sup>

**Ego** <sup>451</sup>

**Diva** <sup>451</sup>

**Nova** <sup>452</sup>

**Nova Plus** <sup>453</sup>

  
**HAFRO**  
acqua, per piacere

Bolla Q 160x160



Bolla 160



Bolla R 162x112



Zaphiro 200x100



Oasy 195x115



Era Plus 180x120/70 dx rh



Era Plus 180x120/70 sx lh



Era Plus 200x120



Era Plus 190x90



Era Plus 180x80



Era Plus 140x140



Era 170x75



Era 170x70



Mode 190x80 dx-sx *rh-lh*Mode 180x90 dx-sx *rh-lh*

Mode 180x75

Mode 170x80 dx-sx *rh-lh*Mode 160x90/70 dx *rh*Mode 160x90/70 sx *lh*

Eva 180x80



Eva 170x70



Duo 170x65/78



Ondaria 180x80



Ondaria 170x75



Ondaria 170x70

Gamma 170x70/76 dx *rh*Gamma 170x70/76 sx *lh*

Igloo 160x160



Ego 150x150



Diva 140x140



Nova 180x80



Nova 170x80



Nova 170x70



Nova 170x65



Nova 160x70



Nova 160x65



Nova 150x70



Nova 140x70



Nova 130x70



Nova 120x70



Nova 110x70



Nova 160x100 dx-sx rh-lh



Nova 140x140



Nova 120x120



Nova Plus 140x140





Si ringrazia Hotel Le Palme (NO-Italia) per le immagini di pagina 20 e 181. Progetto di Desark Contract Sa.

Le immagini stampate non riproducono perfettamente i colori e i toni dei nostri modelli. L'azienda si riserva di apportare tutte le modifiche ritenute necessarie al continuo miglioramento e rinnovamento dei modelli.

*Thanks to Hotel Le Palme (NO-Italy) for the images on page 20 and 181. Project by Desark Contract Sa.*

*The printed images do not reproduce perfectly the colours and shades of our models. The company reserves the rights to make all modification necessary for the improvement and renewal of the model.*



GEROMIN  
GRUPPO

VENEZIA 1945



GRUPPO GEROMIN Srl  
Via 1° Maggio, 5 - 30029 San Stino di Livenza VE-I  
TEL +39 0421 312 249 - 312 250  
[info@gruppogeromin.com](mailto:info@gruppogeromin.com)