

# VOLUMI COLLECTION

**APERTURA SUPERIORE**

*UPPER OPENING*

APERTURA SUPERIOR

p. 221



**APERTURA CENTRALE**

*CENTRAL OPENING*

APERTURA CENTRAL

p. 225



**APERTURA PUSH-PULL**

*PUSH-PULL OPENING*

APERTURA PUSH-PULL

p. 227

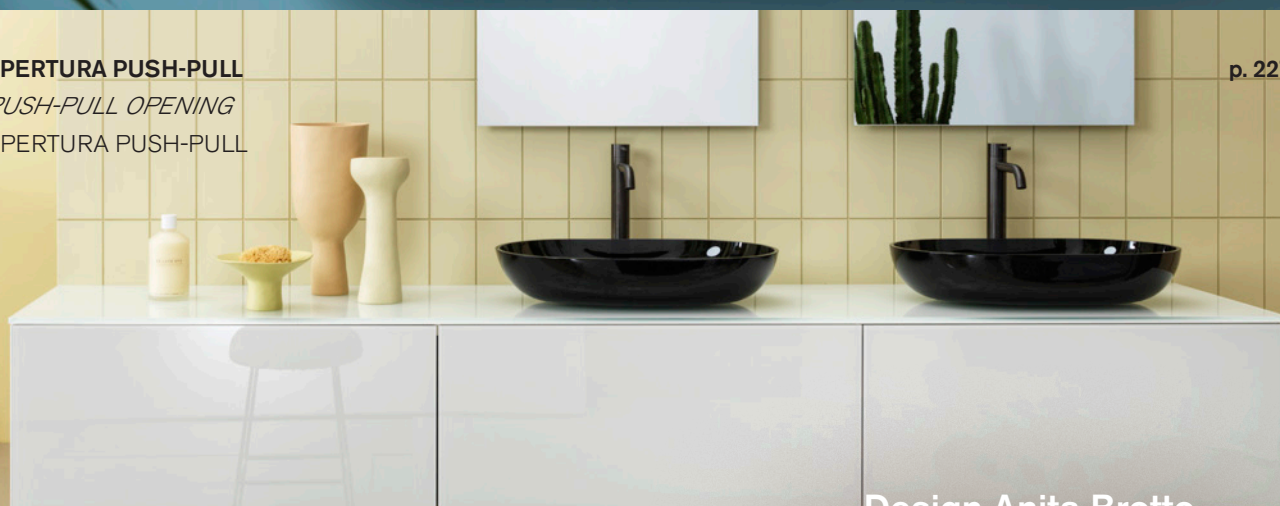

Design Anita Brotto  
**ARTELINEA**  
FIRENZE 1962

# VOLUMI Collection



## ORDINA FACILE

EASY ORDER

ORDENA EL PEDIDO

YOU SHOULD INDICATE IN YOUR PO:

- item code
- strip finish (Titanio/Nero/Bronzo)
- covering colour
- top/basin top colour
- position and type of fusion (for basin tops)
- position and model of basin (for tops)
- position and number of tap holes
- furniture sequence (for compositions)
- options (if requested)

## INDICARE NELL'ORDINE:

- codice articolo
- finitura gola (Titanio/Nero/Bronzo)
- colore rivestimento
- colore top/basintop
- posizione e tipo fusione (per basintop)
- posizione e modello lavabo (per top)
- posizione e numero fori rubinetto
- sequenza dei mobili (per composizioni)
- optional (se richiesti)

## INDICAR EN EL PEDIDO:

- código artículo
- acabado tira (Titanio/Nero/Bronzo)
- color revestimiento
- color top / basintop
- posición y tipo de la fusión (para el basintop)
- posición y modelo de lavabo (para el top)
- posición y número de agujeros para grifería
- secuencia de los muebles (para la composición)
- opciones (si se solicitan)

FORO RUBINETTO  
TAP HOLE  
AGUIEROS

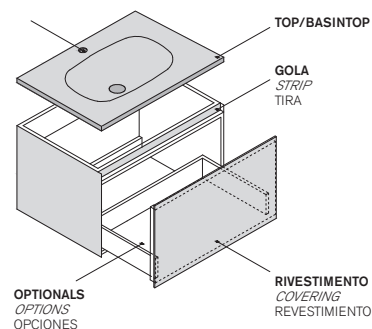

Note:

- 11 Per l'abbinamento con lavabi Artelinea vedi tabella a pag. 53/56. Immagini e dimensioni lavabi vedi pag. da 36 a 51.**  
*For combinations with Artelinea basins see table on pages 53/56. For basin images and dimensions see pages 36/51.*  
Para combinar con lavabos de Artelinea ver tabla pág. 53/56. Imágenes y dimensiones lavabos ver pág. 36 a 51.
- 12 La fascia di tamponamento a misura viene fornita solo per composizioni in nicchia in quanto non prevede la chiusura laterale.**  
*The buffer strip is made to measure and is provided only for recess compositions as it does not have lateral closing.*  
La regleta de ajuste a medida se fabrica solo para composiciones entre tres paredes por lo que no está previsto el cierre lateral.
- 17 BASIN TOP sono realizzati con la fusione INCISA di serie. Sui portalavabo da 60/70 cm e 120/135 cm doppio lavabo le fusioni, fermo restando le caratteristiche tecniche, saranno ridimensionate in funzione dello spazio del mobile.**  
*The BASIN TOPS are produced with INCISA fusion as standard. On our basin units L. 60/70 cm and on our basin units L. 120/135 cm with double basin the fusions will maintain the technical specifications but will be reduced according to the dimensions of the unit.*  
Los BASIN TOP son fabricados con la fusión INCISA de serie. Para portalavabos de 60/70 cm y 120/135 cm doble lavabo, las fusiones teniendo en cuenta las características técnicas serán redimensionadas en función del espacio del mueble.

## CARATTERISTICHE TECNICHE DEL PRODOTTO

TECHNICAL CHARACTERISTICS

CARACTERÍSTICAS TÉCNICAS DEL PRODUCTO

### STRUTTURA - STRUCTURE - ESTRUCTURA

Struttura in nobilitato melaminico idro grigio scuro RAL 7010 con gole in alluminio anodizzato.

*Panels in hydro repellent lacquered melamine laminate dark grey RAL 7010 with strips in anodized aluminum.*

Estructura de ennoblecido melamínico hidro gris oscuro RAL 7010 con tira en aluminio anonizado

### FINITURE GOLE - STRIP FINISHES - ACABADO TIRA



Titanio



Nero



Bronzo

### GUIDE - DRAWER RUNNERS - GUIAS

BLUM ad estrazione totale, movimento LEGRABOX e chiusura sistema BLUMOTION e TIP-ON, regolabili in verticale ed orizzontale. Portata cassetti e cestoni Kg. 40.

*BLUM drawer runners with total extraction, LEGRABOX movement and BLUMOTION and TIP-ON closure systems, adjustable both vertically and horizontally. Drawers can hold up to 40 Kg.*

BLUM de extracción total, movimiento LEGRABOX y cierre sistema BLUMOTION y TIP-ON, regulable en vertical y horizontal. Peso soportado por cajones o cajoneras 40 Kg.

### ATTACCAGLIE - WALL BRACKETS - SOPORTES

Attaccaglie regolabili CAMAR per fissaggio a parete.

*CAMAR adjustable brackets.*

Soporte re gulable CAMAR para fijación a pared.

# VOLUMI Collection

## CARATTERISTICHE TECNICHE DEL PRODOTTO

TECHNICAL CHARACTERISTICS

## CARACTERÍSTICAS TÉCNICAS DEL PRODUCTO

### RIVESTIMENTO ESTERNO - EXTERNAL COVERING - REVESTIMIENTO EXTERNO

CRISTALLO SMALTATO LUCIDO E SILK - GLOSSY AND SILK ENAMELED GLASS - CRISTAL ESMALTADO BRILLO Y SATINADO

LAMINAM@3mm

SPECCHIO FUMÉ GRIGIO/ FUMÉ BRONZO LUCIDO E SILK - GLOSSY OR SILK FUMÉ GRIGIO/ FUMÉ BRONZO MIRRORS - ESPEJO FUMÉ GRIGIO/ FUMÉ BRONZO BRILLO Y SATINADO

FLUTES NERO, BRONZO, BIANCO, TERRA, GRIGIO, NOTTE, SMERALDO e PEONIA. Cristallo cannettato verniciato.

FLUTES NERO, BRONZO, BIANCO, TERRA, GRIGIO, NOTTE, SMERALDO and PEONIA. Enameled fluted glass.

FLUTES NERO, BRONZO, BIANCO, TERRA, GRIGIO, NOTTE, SMERALDO y PEONIA. Cristal acanalado barnizado.

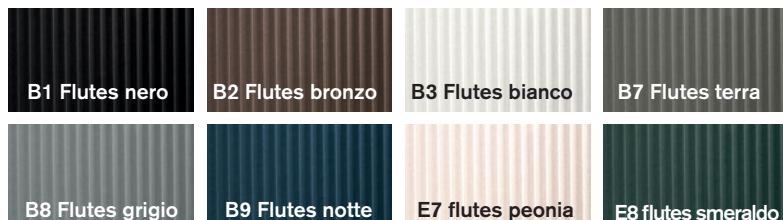

BARCODE BRONZO, BIANCO, GRIGIO, SMERALDO. Cristallo acidato verniciato.

BARCODE BRONZO, BIANCO, GRIGIO, SMERALDO. Enameled acid-etched glass.

BARCODE BRONZO, BIANCO, GRIGIO, SMERALDO. Cristal al ácido barnizado



INCISO QUARZO FUMÉ e TOPAZIO. Cristallo con decoro inciso verniciato.

INCISO QUARZO FUMÉ and TOPAZIO. Enameled glass with engraved decoration.

INCISO QUARZO FUMÉ e TOPAZIO. Cristal con decoración inciso barnizado.

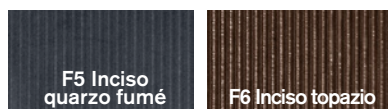

I cristalli colorati Artelinea sono garantiti secondo i termini di legge. Artelinea enameled glass is guaranteed according to the terms of law. El cristal coloreado de Artelinea está garantizado con las condiciones legales.



# VOLUMI Collection

## SCHEDE TECNICHE PER INSTALLAZIONE

TECHNICAL INSTALLATION ADVICE

ESQUEMA TECNICO PARA INSTALACION

<p><b>PORTALAVABO H.35 cm</b>  <i>BASIN UNITS H.35 CM</i>            PORTALAVABO H.35 CM</p>	<p><b>PORTALAVABO H.50 cm</b>  <i>BASIN UNITS H.50 CM</i>            PORTALAVABO H.50 CM</p>
<p><b>BASINTOP/LAVABI SOTTOPIANO</b>  <i>BASIN TOPS/ UNDER LEVEL WASH-BASINS</i>            BASINTOP/LAVABO BAJOENCIMERA</p>	<p><b>BASINTOP/LAVABI SOTTOPIANO</b>  <i>BASIN TOPS/ UNDER LEVEL WASH-BASINS</i>            BASINTOP/LAVABO BAJOENCIMERA</p>
<p><b>LAVABI IN APPOGGIO H = 10/13 cm</b>  <i>OVER LEVEL WASH-BASINS H = 10/13 cm</i>            LAVABO DE APOYO H = 10/13 cm</p>	<p><b>LAVABI IN APPOGGIO H = 10/13 cm</b>  <i>OVER LEVEL WASH-BASINS H = 10/13 cm</i>            LAVABO DE APOYO H = 10/13 cm</p>
<p><b>LAVABI IN APPOGGIO H = 6/9 cm</b>  <i>OVER LEVEL WASH-BASINS H = 6/9 cm</i>            LAVABO DE APOYO H = 6/9 CM</p>	<p><b>LAVABI IN APPOGGIO H = 6/9 cm</b>  <i>OVER LEVEL WASH-BASINS H = 6/9 cm</i>            LAVABO DE APOYO H = 6/9 CM</p>

**Modularità**  
Modularity  
Modularidad

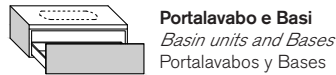
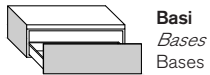

**Lavabi consentiti - Allowed basins - Lavabos permitidos**

- Lavabo appoggio - Over level basins - Lavabos de apoyo**
- Lavabo semincasso - Semi-recessed basins - Lavabos semiencastrare**
- Lavabo sottopiano - Under level basins - Lavabos bajo encimera**
- Lavabo integrato - Integrated basins - Lavabo integrato**

**APERTURA MANUALE**  
MANUAL OPENING SYSTEM  
APERTURA MANUAL

**H 35 CM**  
**P 51 CM**

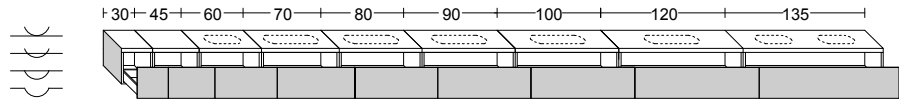

**H 50 CM**  
**P 51 CM**

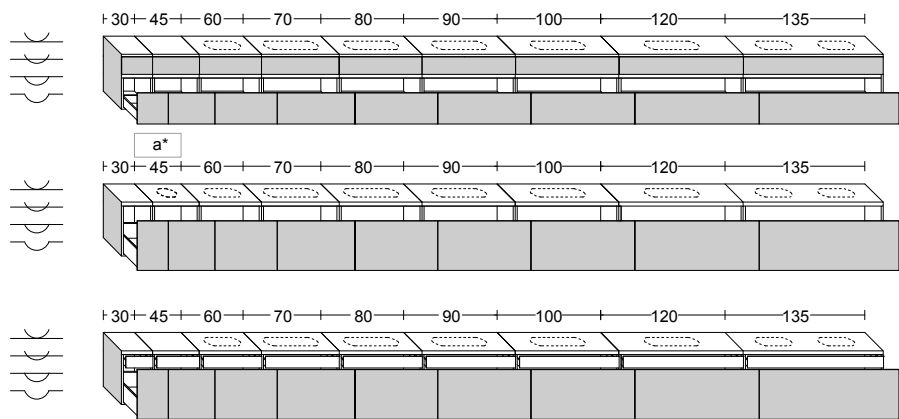

**APERTURA PUSH-PULL**  
PUSH-PULL OPENING SYSTEM  
APERTURA PUSH-PULL

**H 35 CM**  
**P 51 CM**

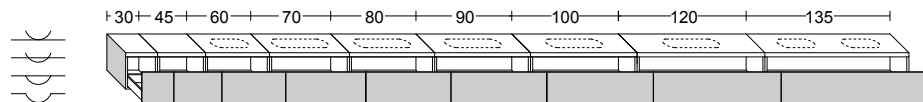

**FUSIONE - FUSIONS - FUSIÓN**

**INCISA48 (CRISTALLO/OPALITE)**

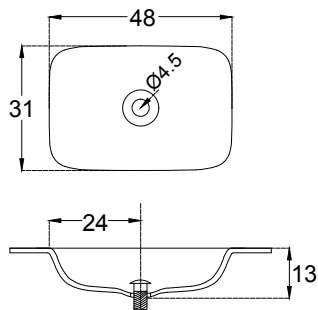

**INCISA62 (CRISTALLO/OPALITE/CRISTALPLANT)**

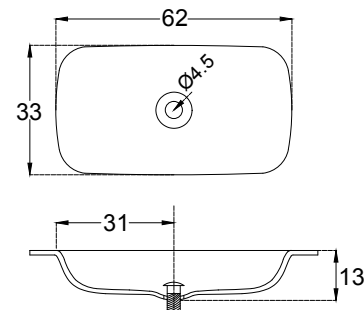

**Alcuni esempi di composizioni.**

*Examples of compositions.*

Algunos ejemplos de composiciones.

90		100/105/110				
115/120/125						
130/135/140						
145/150						
160/165						
170/180						
185/190/200						
205/210/215						
220/225/230						
235/240						

# VOLUMI COLLECTION

APERTURA SUPERIORE  
UPPER OPENING  
APERTURA SUPERIOR



VOLUMI

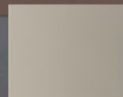

Titanio

FINITURA GOLA  
STRIP FINISHES  
ACABADO TIRA

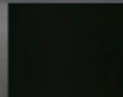

Nero

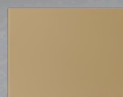

Bronzo

Design Anita Brotto  
**ARTELINEA**  
FIRENZE 1962

OPTIONAL

# VOLUMI Collection

PROFONDITA' - DEPTH - PROFUNDIDAD 51 cm - H 35 cm

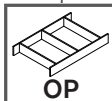

pag.527

## PortLavabo e basi con 1 cassetto.

Basin units and base units with 1 drawer.

PortLavabo y bases con 1 cajón.

APERTURA SUPERIORE

UPPER OPENING

APERTURA SUPERIOR

Finiture gola: Titanio, Nero, Bronzo.

Strip finishes: Titanio, Nero, Bronzo.

Acabado tira: Titanio, Nero, Bronzo

CRISTALLO SMALTATO  
Enamelled crystal  
Cristal esmaltado  
FLUTES  
SPECCHI

LAMINAM®  
BARCODE  
INCISO

Note: 11 (pag.216)

### PortLavabo con cassetto asolato per passaggio sifone. Lavabo centrale.

Basin unit with central drainage hole. Central basin.

PortLavabo 1 cajón con ojal para paso de sifón. Lavabo centrado.

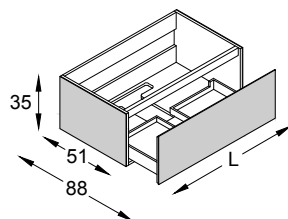

L cm Art.

60	VLA60		
70	VLA70		
80	VLA80		
90	VLA90		
100	VLA100		
120	VLA120		
*135	VLA135 ct - sx - dx		

\* versione sx/dx con centro asola a 45cm dal bordo

\* Left or right basin with drainage hole at 45 cm from the sides.

\* versión sx/dx con centro ojal a 45 cm del borde

Note: 11 (pag.216)

### PortLavabo con cassetto asolato per passaggio sifone. Lavabo doppio.

Basin unit with drainage holes. Double basins.

PortLavabo 1 cajón con ojal para paso de sifón. Doble lavabo.

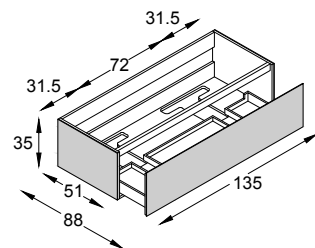

L cm Art.

135	VLA135D		
-----	---------	--	--

Note: 11 (pag.216)

### Base con 1 cassetto intero.

Base unit with 1 drawer.

Base con 1 cajón entero

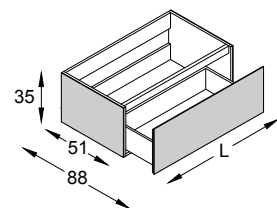

L cm Art.

30	VLY30		
45	VLY45		
60	VLY60		
70	VLY70		
80	VLY80		
90	VLY90		
100	VLY100		
120	VLY120		
135	VLY135		



## Portlavabo e basi con cestone.

Basin units and base units with deep drawers.

Portlavabo y bases con cajonera.

APERTURA SUPERIORE

UPPER OPENING

APERTURA SUPERIOR

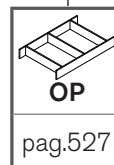

Finiture gola: Titanio, Nero, Bronzo.

Strip finishes: Titanio, Nero, Bronzo.

Acabado tira: Titanio, Nero, Bronzo

**CRISTALLO SMALTATO**  
Enameled crystal  
Cristal esmaltado  
**FLUTES**  
**SPECCHI**

**LAMINAM®**  
**BARCODE**  
**INCISO**

Note: 11 (pag.216)

## Portlavabo con cestone, divisori in cristallo e cassetto interno asolato per passaggio sifone. Lavabo centrale.

Basin unit with deep drawer, glass dividers and inner drawer with drainage hole. Central basin.

Portlavabo con cajonera, divisorio de cristal, cajón interno con ojal para paso de sifón. Lavabo centrado.

\* versión sx/dx con centro ojal a 45 cm del borde

\* Left or right basin with drainage hole at 45 cm from the sides.

\* versión sx/dx con centro ojal a 45 cm del borde

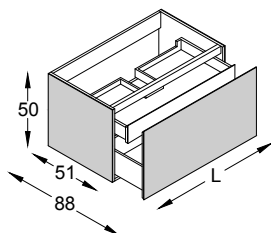

L cm Art.

60	VLE60		
70	VLE70		
80	VLE80		
90	VLE90		
100	VLE100		
120	VLE120		
* 135	VLE135 ct - sx - dx		

Note: 11 (pag.216)

## Portlavabo con cestone, divisori in cristallo e cassetto interno asolato per passaggio sifoni. Lavabo doppio.

Basin unit with deep drawer, glass dividers and inner drawer with drainage holes. Double basins.

Portlavabo con cajonera, divisorio de cristal, cajón interno con ojal para paso de sifón. Doble lavabo.

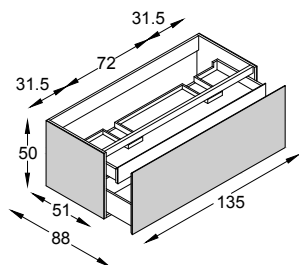

L cm Art.

135	VLE135D		
-----	---------	--	--

Note: 11 (pag.216)

## Portlavabo e base con cestone e divisori in cristallo. Lavabo centrale.

Basin unit and base unit with deep drawer and glass dividers. Central basin.

Portlavabo y base con cajonera y divisorio de cristal. Lavabo centrado.

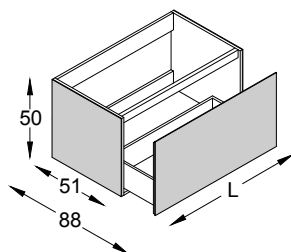

L cm Art.

30	VLF30		
45	VLF45		
60	VLF60		
70	VLF70		
80	VLF80		
90	VLF90		
100	VLF100		
120	VLF120		
135	VLF135		

## Base con cestone, divisori in cristallo e cassetto interno.

Base unit with deep drawer, glass dividers and inner drawer.

Base con cajonera, divisorio de cristal y cajón interno.

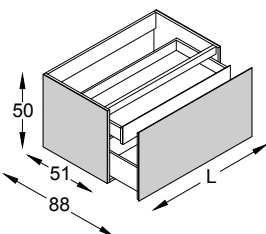

L cm Art.

30	VLL30		
45	VLL45		
60	VLL60		
70	VLL70		
80	VLL80		
90	VLL90		
100	VLL100		
120	VLL120		
135	VLL135		

## VOLUMI Collection

### Mobile H 35cm con apertura superiore

*35cm H. unit with upper opening*

Mueble H.35cm. con apertura superior



### Mobile H 50cm con apertura superiore

*50cm H. unit with upper opening*

Mueble H.50 con apertura superior



### Mobile H 50cm con apertura centrale

*50cm H. unit with central opening*

Mueble H.50cm con apertura central



# VOLUMI COLLECTION

APERTURA CENTRALE  
CENTRAL OPENING  
APERTURA CENTRAL



VOLUMI

②

①

②



Titanio



Nero



Bronzo

FINITURA GOLA  
STRIP FINISHES  
ACABADO TIRA

Variante bicolore - Example of bicolor vanity - Variante bicolor

① 1° cassetto - 1st drawer - 1er cajón

② 2° cassetto=fianchi - 2nd drawer=sides - 2° cajón-lados

Design Anita Brotto  
**ARTELINEA**  
FIRENZE 1962

OPTIONAL

# VOLUMI Collection

PROFONDITA' - DEPTH - PROFUNDIDAD 51 cm - H 50 cm

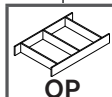

pag.527

## PortLavabo e basi con 2 cassetti.

*Basin units and base units with 2 drawers.*

PortLavabo y bases con 2 cajones.

APERTURA CENTRALE

CENTRAL OPENING

APERTURA MANUALE

Finiture gola: Titanio, Nero, Bronzo.

*Strip finishes: Titanio, Nero, Bronzo.*

Acabado tira: Titanio, Nero, Bronzo

**CRISTALLO SMALTATO**  
*Enameled crystal*  
Cristal esmaltado  
**FLUTES**  
**SPECCHI**

**LAMINAM®**  
**BARCODE**  
**INCISO**  
**Bicolore**  
*two-color*  
Bicolor

Note: 11 (pag.216)

## PortLavabo con frontale fisso e cassetto.

*Base unit with unmovable front panel and drawer.*

PortLavabo con frontal fijo y cajón

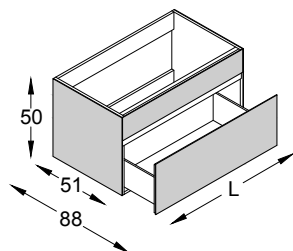

L cm Art.

60 VLC60

70 VLC70

80 VLC80

90 VLC90

100 VLC100

120 VLC120

135 VLC135

Note: 11 (pag. 216)

## PortLavabo con 1° cassetto asolato per passaggio sifone e 2° cassetto intero. Lavabo centrale, SOLO TOP con LAVABI IN APPOGGIO.

*Basin unit with 1st drawer with central drainage hole and 2nd drawer without hole. Central basin, TOPS ONLY with SIT ON BASINS.*

PortLavabo con 1er cajón con agujero para paso del sifón y 2° cajón completo con divisores de cristal. Lavabo centrado, SOLO TOP con LAVABO DE APOYO.

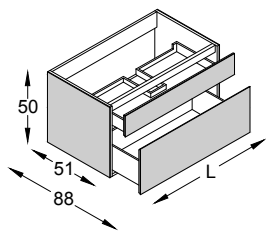

L cm Art.

60 VLD60

70 VLD70

80 VLD80

90 VLD90

100 VLD100

120 VLD120

\*135 VLD135 ct - sx - dx

\*versione sx/dx con centro asola a 45cm dal bordo

*\* Left or right basin with drainage hole at 45 cm from the sides.*

\* versión sx/dx con centro ojal a 45 cm del borde

Note: 11 (pag. 216)

## PortLavabo con 1° cassetto asolato per passaggio sifone e 2° cassetto intero. Lavabo doppio, SOLO TOP con LAVABI IN APPOGGIO.

*Basin unit with 1st drawer with drainage holes and 2nd drawer without hole. Double basins, TOPS ONLY with SIT ON BASINS.*

PortLavabo con el 1er cajón con ojal para paso del sifón y 2° cajón completo. Lavabo doble, SOLO TOP con LAVABO DE APOYO

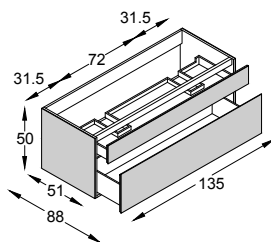

L cm Art.

135 VLD135D

## Base con 2 cassetti interi.

*Base unit with 2 drawers.*

Base con 2 cajones completos

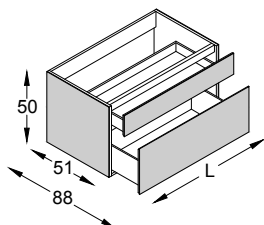

L cm Art.

30 VLK30

45 VLK45

60 VLK60

70 VLK70

80 VLK80

90 VLK90

100 VLK100

120 VLK120

135 VLK135

Colori vedi pag. 12/15. - Colours see pages 12/15. - Colores ver pag. 12/15.

# VOLUMI COLLECTION

APERTURA PUSH-PULL  
*PUSH-PULL OPENING*  
APERTURA PUSH-PULL



VOLUMI

Design Anita Brotto  
**ARTELINEA**  
FIRENZE 1962

OPTIONAL

# VOLUMI Collection

PROFONDITA' - DEPTH - PROFUNDIDAD 51 cm - H 35 cm

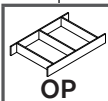

pag.527

## Portavavabo e basi con 1 cassetto.

Basin units and base units with 1 drawer.

Portavavabo y bases con 1 cajón.

APERTURA PUSH-PULL

PUSH-PULL OPENING

APERTURA PUSH-PULL

CRISTALLO SMALTATO  
Enameled crystal  
Cristal esmaltado  
FLUTES  
SPECCHI

LAMINAM®  
BARCODE  
INCISO

Note: 11 (pag. 216)

### Portavavabo con cassetto asolato per passaggio sifone. Lavabo centrale.

Basin unit with central drainage hole. Central basin.

Portavavabo 1 cajón con ojal para paso de sifón. Lavabo centrado.

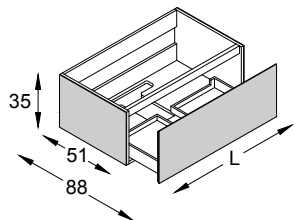

L cm Art.

60 VLP60

70 VLP70

80 VLP80

90 VLP90

100 VLP100

120 VLP120

\*135 VLP135 ct - sx - dx

\* versione sx/dx con centro asola a 45cm dal bordo

\* Left or right basin with drainage hole at 45 cm from the sides.

\* versión sx/dx con centro ojal a 45 cm. del borde

Note: 11 (pag. 216)

### Portavavabo con cassetto asolato per passaggio sifone. Lavabo doppio.

Basin unit with drainage holes. Double basins.

Portavavabo 1 cajón con ojal para paso de sifón. Doble lavabo.

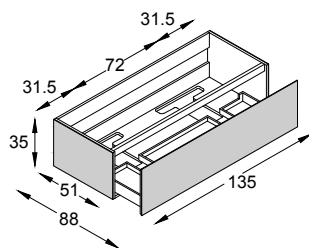

L cm Art.

135 VLP135D

### Base con 1 cassetto intero.

Base unit with 1 drawer.

Base con 1 cajón entero

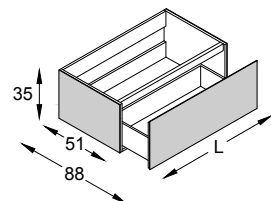

L cm Art.

30 VLT30

45 VLT45

60 VLT60

70 VLT70

80 VLT80

90 VLT90

100 VLT100

120 VLT120

135 VLT135

**Fascia di tamponamento per composizioni a misura in nicchia.**

*Buffering strips for made-to-measure recess compositions.*

Regleta de ajuste para composiciones a medida entre tres paredes

**CRISTALLO SMALTATO**  
*Enameled crystal*  
 Cristal esmaltado  
**FLUTES**  
**SPECCHI**

**LAMINAM®**  
**BARCODE**  
**INCISO**

Note: 12 (pag. 216)

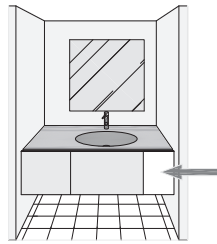
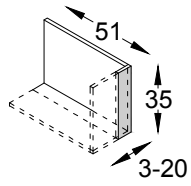

L cm	Art.	Art.
3 → 20	VLY2M sx	VLY2M dx

Note: 12 (pag. 216)

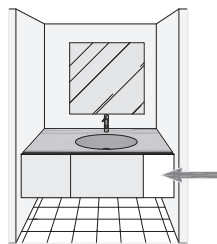
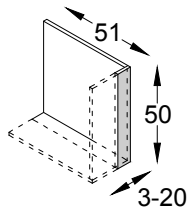

L cm	Art.	Art.
3 → 20	VLE2M sx	VLE2M dx

VOLUMI

### BASIN TOP CRISTALLO, OPALITE, OPITECH E CRISTALPLANT

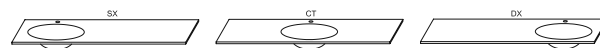

Indicare posizione lavabo - Indicate position of basin - Indicar posición lavabo

Note: 17 (pag. 216)

Basin top in CRISTALLO smaltato LUCIDO e SILK, OPALITE bianco e nero, OPITECH (gelcoat lucido e opaco) e CRISTALPLANT (solid surface opaco) - FUSIONE SINGOLA. Per info vedi pag. 552/562

Basin top in enameled GLOSSY and SILK GLASS, white and black OPALITE, OPITECH (glossy and matt gelcoat) and CRISTALPLANT (matt solid surface) - SINGLE FUSION. For any details see pages 552/562.

Basin top en cristal esmaltado BRILLO y SATINADO, OPALITE blanco y negro, OPITECH (gelcoat brillo y opaco) y CRISTALPLANT (solid surface opaco)-FUSIÓN INDIVIDUAL. Para información adicional ver pág. 552/562.

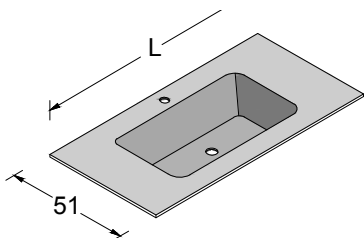

- 1) Foro rubinetteria monoforo centrale di serie. Su richiesta senza foro, 3 fori.**  
Single central tap hole as standard. Upon request 3 tap holes or no tap hole.  
Agujero grifería centrado de serie. Sobre pedido sin agujero, 3 agujeros.
- 2) Basintop per composizioni a misura prendere il prezzo della lunghezza superiore. (Es. composizione 208 cm prezzo top 210 cm).**  
Use tops of a wider length for made-to-measure compositions (Ex. for a composition L. 208 cm consider the top L. 210 cm).  
Encimera para composiciones a medida tomar el precio de la longitud superior (Ejemplo: composición 208 cm precio encimera 210 cm).
- 3) Sui basintop in OPITECH la fusione sarà rettangolare e ridimensionata in funzione dello spazio del mobile (vedi pag. 560)**  
OPITECH basin tops have a rectangular fusion. The fusion dimensions depend on the available space in the below vanity (see p.560).  
Los basintop en OPITECH tendrán la fusión rectangular y redimensionada en función del espacio del mueble. (ver pág. 560)
- 4) I basintop in CRISTALLO SILK hanno fusione lucida**  
Basintops in silk finish always have the fusion in glossy finish.  
Los basintops en cristal satinado tienen la fusión brillo

L cm	Art.	CRISTALLO	CRISTALLO SILK	OPALITE BIANCO	OPALITE NERO	OPITECH	CRISTALPLANT
60	BTVL60						
70	BTVL70						
80	BTVL80						
90	BTVL90						
100	BTVL100						
105	BTVL105						
110	BTVL110						
115	BTVL115						
120	BTVL120						
125	BTVL125						
130	BTVL130						
135	BTVL135						
140	BTVL140						
145	BTVL145						
150	BTVL150						
160	BTVL160						
165	BTVL165						
170	BTVL170						
180	BTVL180						
185	BTVL185						
190	BTVL190						
195	BTVL195						
200	BTVL200						
205	BTVL205						
210	BTVL210						
215	BTVL215						
220	BTVL220						
225	BTVL225						
230	BTVL230						
235	BTVL235						
240	BTVL240						



Molatura bordi - Edge grinding - Acabados del borde



Inclusa - Included - Incluida

Fusione INCISA di serie - Standard fusion INCISA - Fusion INCISA de serie

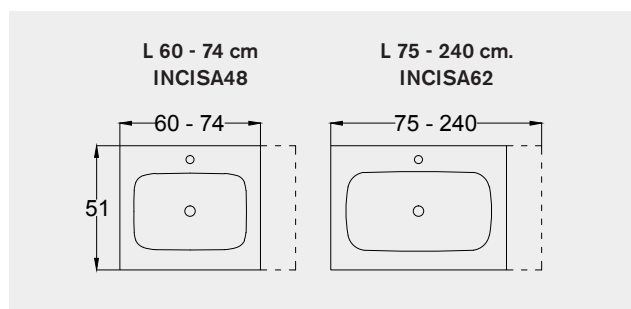

Colori vedi pag. 12/15. - Colours see pages 12/15 - Colores ver pág. 12/15.

FUSIONI - Vedi p. 219. - FUSIONS - see page 219. - FUSIONES - ver pág. 219.

Trattamento anticalcareo vedi pag. 548. - Anti-limescale treatment see page 548. - Tratamiento anticalcareo ver pag. 548.



BASIN TOP CRISTALLO, OPALITE, OPITECH E CRISTALPLANT

Note: 17 (pag. 216)

Basin top in CRISTALLO smaltato LUCIDO e SILK, OPALITE bianco e nero, OPITECH (gelcoat lucido e opaco) e CRISTALPLANT (solid surface opaco) - FUSIONE DOPPIA. Per info vedi pag. 552/562

Basin top in enameled GLOSSY and SILK GLASS, white and black OPALITE, OPITECH (glossy and matt gelcoat) and CRISTALPLANT (matt solid surface) - DOUBLE FUSION. For any details see pages 552/562.

Basin top en cristal esmaltado BRILLO y SATINADO, OPALITE blanco y negro, OPITECH (gelcoat brillo y opaco) y CRISTALPLANT (solid surface opaco)-FUSIÓN DOBLE. Para información adicional ver pág. 552/562.

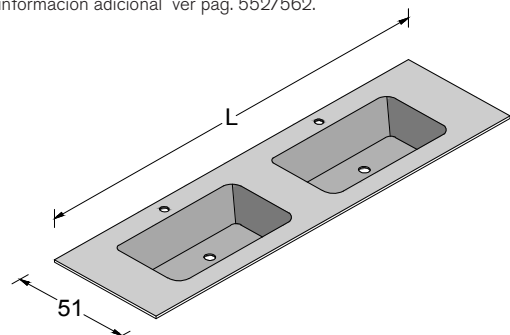

- 1) Foro rubinetteria monoforo centrale di serie. Su richiesta senza foro, 3 fori.

Single central tap hole as standard. Upon request 3 tap holes or no tap hole.

Agujero grifería centrado de serie. Sobre pedido sin agujero, 3 agujeros.

- 3) Sui basintop in OPITECH la fusione sarà rettangolare e ridimensionata in funzione dello spazio del mobile (vedi pag. 560)

OPITECH basin tops have a rectangular fusion. The fusion dimensions depend on the available space in the below vanity (see p.560).

Los basintop en OPITECH tendrán la fusión rectangular y redimensionada en función del espacio del mueble (ver pág. 560).

- 2) Basintop per composizioni a misura prendere il prezzo della lunghezza superiore (Es. composizione 208 cm prezzo top 210 cm).

Use tops of a wider length for made-to-measure compositions (Ex. for a composition L. 208 cm consider the top L. 210 cm).

Encimera para composiciones a medida tomar el precio de la longitud superior (Ejemplo: composición 208 cm precio encimera 210 cm).

- 4) I basintop in CRISTALLO SILK hanno fusione lucida

Basintops in silk finish always have the fusion in glossy finish.

Los basintops en cristal satinado tienen la fusión brillo

L cm	Art.	CRISTALLO	CRISTALLO SILK	OPALITE BIANCO	OPALITE NERO	OPITECH	CRISTALPLANT
135	BTVLD135						
140	BTVLD140						
150	BTVLD150						
160	BTVLD160						
165	BTVLD165						
170	BTVLD170						
180	BTVLD180						
185	BTVLD185						
190	BTVLD190						
195	BTVLD195						
200	BTVLD200						
205	BTVLD205						
210	BTVLD210						
215	BTVLD215						
220	BTVLD220						
225	BTVLD225						
230	BTVLD230						
235	BTVLD235						
240	BTVLD240						



Molatura bordi - Edge grinding - Acabados del borde



Inclusa - Included - Incluida

Fusione INCISA di serie - Standard fusion INCISA - Fusion INCISA de serie

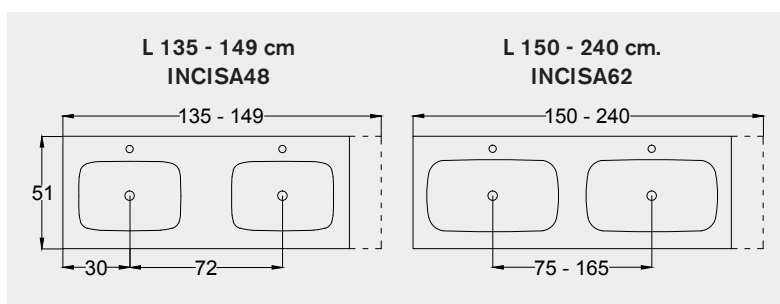

Colori vedi pag. 12/15. - Colours see pages 12/15 - Colores ver pág. 12/15.

FUSIONI - Vedi p. 219. - FUSIONS - see page 219. - FUSIONES - ver pág. 219.

Trattamento anticalcareo vedi pag. 548. - Anti-limescale treatment see page 548. - Tratamiento anticalcareo ver pag. 548.

VOLUMI

### TOP CRISTALLO, OPALITE, OPITECH E CRISTALPLANT

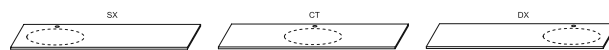

Indicare posizione lavabo - Indicate position of basin - Indicar posición lavabo

Top in CRISTALLO smaltato LUCIDO e SILK, OPALITE bianco e nero, OPITECH (gelcoat lucido e opaco) e CRISTALPLANT (solid surface opaco) per lavabo in appoggio, sottopiano e semincasso - LAVABO SINGOLO. Per info vedi pag. 552/562

Top in enameled GLOSSY and SILK GLASS, white and black OPALITE, OPITECH (glossy and matt gelcoat) and CRISTALPLANT (matt solid surface) - SINGLE over level, semi-recessed and recessed BASIN. For any details see pages 552/562.

Basin top en cristal esmaltado BRILLO y SATINADO, OPALITE blanco y negro, OPITECH (gelcoat brillo y opaco) y CRISTALPLANT (solid surface opaco para lavabos de apoyo, bajoencimera y semiencastré) - LAVABO INDIVIDUAL. Para información adicional ver pág. 552/562.

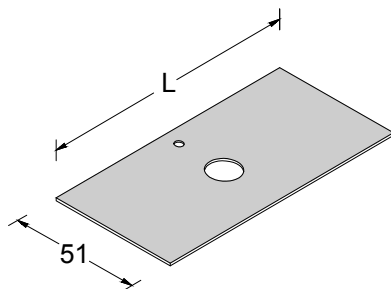

- 1) Foro rubinetteria monoforo centrale di serie. Su richiesta senza foro, 3 fori.

Single central tap hole as standard. Upon request 3 tap holes or no tap hole.

Agujero grifería centrado de serie. Sobre pedido sin agujero, 3 agujeros.

- 2) Top per composizioni a misura prendere il prezzo della lunghezza superiore (Es. composizione 208 cm prezzo top 210 cm).

Use tops of a wider length for made-to-measure compositions (Ex. for a composition L. 208 cm consider the top L. 210 cm).

Encimera para composiciones a medida tomar el precio de la longitud superior (Ejemplo: composición 208 cm precio encimera 210 cm)

- 3) Per l'utilizzo di altri lavabi no Artelinea indicare marca e modello con aumento. Richiedere fattibilità.

For all the basins which are not produced by Artelinea please indicate brand and model and increase the price of the top. Ask for feasibility.

Para lavabos de otros fabricantes indicar marca y modelo con aumento. Consultar factibilidad.

L cm	Art.	CRISTALLO	CRISTALLO SILK	OPALITE BIANCO	OPALITE NERO	OPITECH	CRISTALPLANT
45	KVL45						
60	KVL60						
70	KVL70						
80	KVL80						
90	KVL90						
100	KVL100						
105	KVL105						
110	KVL110						
115	KVL115						
120	KVL120						
125	KVL125						
130	KVL130						
135	KVL135						
140	KVL140						
145	KVL145						
150	KVL150						
160	KVL160						
165	KVL165						
170	KVL170						
180	KVL180						
185	KVL185						
190	KVL190						
195	KVL195						
200	KVL200						
205	KVL205						
210	KVL210						
215	KVL215						
220	KVL220						
225	KVL225						
230	KVL230						
235	KVL235						
240	KVL240						



Molatura bordi - Edge grinding - Acabados del borde

Colori vedi pag. 12/15. - Colours see pages 12/15. - Colores ver pag. 12/15.

Trattamento anticalcareo vedi pag. 548. - Anti-limescale treatment see page 548. - Tratamiento anticalcareo ver pag. 548.

Lavabi vedi pag. 36/51. - Basins see pages 36/51. - Lavabos ver pag. 36/51.

### TOP CRISTALLO, OPALITE, OPITECH E CRISTALPLANT

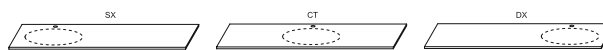

Indicare posizione lavabo - Indicate position of basin - Indicar posición lavabo

Top in CRISTALLO smaltato LUCIDO e SILK, OPALITE bianco e nero, OPITECH (gelcoat lucido e opaco) e CRISTALPLANT (solid surface opaco) per lavabo in appoggio, sottopiano e semincasso - LAVABO DOPPIO. Per info vedi pag. 552/562

Top in enameled GLOSSY and SILK GLASS, white and black OPALITE, OPITECH (glossy and matt gelcoat) and CRISTALPLANT (matt solid surface) - DOUBLE over level, semi-recessed and recessed BASIN. For any details see pages 552/562.

Basin top in cristal esmaltado BRILLO y SATINADO, OPALITE blanco y negro, OPITECH (gelcoat brillo y opaco) y CRISTALPLANT (solid surface opaco) para lavabos de apoyo, bajoencimera y semiencastre - LAVABO DOBLE. Para información adicional ver pag. 552/562.

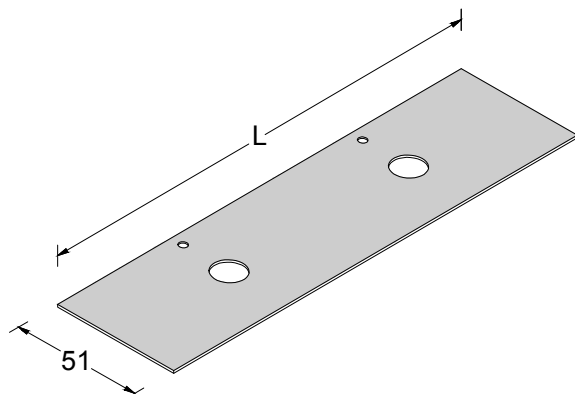

- 1) Foro rubinetteria monoforo centrale di serie.  
Su richiesta senza foro, 3 fori.

Single central tap hole as standard.  
Upon request 3 tap holes or no tap hole.

Agujero grifería centrado de serie.  
Sobre pedido sin agujero, 3 agujeros.

- 2) Top per composizioni a misura prendere il prezzo della lunghezza superiore (Es. composizione 208 cm prezzo top 210 cm).

Use tops of a wider length for made-to-measure compositions (Ex. for a composition L. 208 cm consider the top L. 210 cm).

Encimera para composiciones a medida tomar el precio de la longitud superior (Ejemplo: composición 208 cm precio encimera 210 cm)

- 3) Per l'utilizzo di altri lavabi no Artelinea indicare marca e modello con aumento. Richiedere fattibilità.

For all the basins which are not produced by Artelinea please indicate brand and model and increase the price of the top. Ask for feasibility.

Para lavabos de otros fabricantes indicar marca y modelo con aumento. Consultar factibilidad.

L cm	Art.	CRISTALLO	CRISTALLO SILK	OPALITE BIANCO	OPALITE NERO	OPITECH	CRISTALPLANT
120	KVLD120						
135	KVLD135						
140	KVLD140						
150	KVLD150						
160	KVLD160						
165	KVLD165						
170	KVLD170						
180	KVLD180						
185	KVLD185						
190	KVLD190						
195	KVLD195						
200	KVLD200						
205	KVLD205						
210	KVLD210						
215	KVLD215						
220	KVLD220						
225	KVLD225						
230	KVLD230						
235	KVLD235						
240	KVLD240						



Molatura bordi - Edge grinding - Acabados del borde

Colori vedi pag. 12/15. - Colours see pages 12/15. - Colores ver pag. 12/15.

Trattamento anticalcare vedi pag. 548. - Anti-limescale treatment see page 548. - Tratamiento anticalcareo ver pag. 548.

Lavabi vedi pag. 36/51. - Basins see pages 36/51. - Lavabos ver pag. 36/51.

TOP CRISTALLO, OPALITE, OPITECH E CRISTALPLANT

Top in CRISTALLO smaltato LUCIDO e SILK, OPALITE bianco e nero, OPITECH (gelcoat lucido e opaco) e CRISTALPLANT (solid surface opaco) per basi senza lavabo. Per info vedi pag. 552/562.

Top in enameled GLOSSY and SILK GLASS, white and black OPALITE, OPITECH (glossy and matt gelcoat) and CRISTALPLANT (matt solid surface) for base units without basin. For any details see pages 552/562.

Basin top en cristal esmaltado BRILLO y SATINADO, OPALITE blanco y negro, OPITECH (gelcoat brillo y opaco) y CRISTALPLANT (solid surface opaco) para bases sin lavabo. Para información adicional ver pág. 552/562.

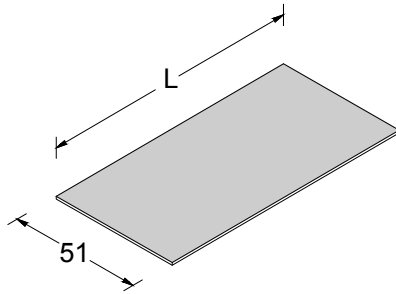

L cm	Art.	CRISTALLO	CRISTALLO SILK	OPALITE BIANCO	OPALITE NERO	OPITECH	CRISTALPLANT
30	KVLC30						
45	KVLC45						
60	KVLC60						
70	KVLC70						
80	KVLC80						
90	KVLC90						
100	KVLC100						
105	KVLC105						
110	KVLC110						
115	KVLC115						
120	KVLC120						
125	KVLC125						
130	KVLC130						
135	KVLC135						
140	KVLC140						
145	KVLC145						
150	KVLC150						
160	KVLC160						
165	KVLC165						
170	KVLC170						
180	KVLC180						
185	KVLC185						
190	KVLC190						
195	KVLC195						
200	KVLC200						
205	KVLC205						
210	KVLC210						
215	KVLC215						
220	KVLC220						
225	KVLC225						
230	KVLC230						
235	KVLC235						
240	KVLC240						

Top per composizioni a misura prendere il prezzo della lunghezza superiore (Es. composizione 208 cm prezzo top 210 cm).

Use tops of a wider length for made-to-measure compositions (Ex. for a composition L. 208 cm consider the top L. 210 cm).

Encimera para composiciones a medida tomar el precio de la longitud superior (Ejemplo: composición 208 cm precio encimera 210 cm)



Molatura bordi - Edge grinding - Acabados del borde

Colori vedi pag. 12/15. - Colours see pages 12/15. - Colores ver pag. 12/15.

Trattamento anticalcare vedi pag. 548. - Anti-limescale treatment see page 548. - Tratamiento anticalcareo ver pag. 548.